

Appendix I

Transportation Impact Study

Aramis Solar Energy Generation and Storage Project Transportation Impact Study

Final Report

Prepared for:

IP Aramis, LLC

HELIX Environmental Planning, Inc.

Prepared by:

CHS Consulting Group

170 Maiden Lane, Fifth Floor
San Francisco, California 94108

September 2020

Table of Contents

Section	Page
1.0 INTRODUCTION.....	1
1.1 Project Location and Site	1
1.2 Project Description	3
1.3 Study Scope and Approach.....	6
2.0 EXISTING CONDITIONS.....	7
2.1 Roadway Network	7
2.2 Intersection Traffic Volumes	8
2.3 Level of Service Methodology.....	10
2.4 Level of Service Analysis – Existing Conditions	10
2.5 95 th Percentile Vehicle Queue Length Analysis – Existing Conditions.....	10
2.6 Vehicle Miles Traveled (VMT) – Existing Conditions	11
2.7 Transit Conditions.....	11
2.8 Walking/Accessibility Conditions	13
2.9 Bicycle Conditions.....	13
3.0 REGULATORY SETTING.....	16
3.1 Alameda County	16
3.2 Alameda County Transportation Commission (Alameda CTC)	16
3.3 California Department of Transportation (Caltrans).....	17
3.4 Project Study Transportation Metric.....	17
3.5 State Significance Criteria (CEQA)	17
4.0 EXISTING PLUS PROJECT CONDITIONS.....	18
4.1 Project Trip Generation.....	18
4.2 Project Trip Distribution and Assignment	20
4.3 Level of Service Analysis – Existing plus Project Conditions	24
4.4 95 th Percentile Vehicle Queue Length Analysis – Existing plus Project Conditions	24
4.5 Vehicle Miles Traveled – Existing plus Project Conditions	25
4.6 Impact Discussion (CEQA Appendix G Checklist)	27
5.0 CONCLUSIONS	29

Tables and Figures

Tables	Page
Table 1: Existing Conditions: Peak Hour Intersection Level of Service Results	10
Table 2: Existing Conditions: Peak Hour Intersection Queue Analysis Results	11
Table 3: Worker Trips by Construction Phase	18
Table 4: Truck Haul Trips by Construction Phase	19
Table 5: Total Project Trips by Construction Phase.....	20
Table 6: Distribution of Project Construction Workers by Origin City	21
Table 7: Peak Hour Project Vehicle Trip Distribution	21
Table 8: Existing plus Project Conditions: Peak Hour Intersection LOS Results	24
Table 9: Existing plus Project Conditions: Peak Hour Intersection Queue Analysis Results	25
Table 10: Project-Generated VMT Analysis Results	26

Figures	Page
Figure 1 Project Location	2
Figure 2 Project Site Plan	5
Figure 3 Existing Conditions Lane Configurations and Peak Hour Traffic Volumes	9
Figure 4 Existing Transit Network.....	12
Figure 5 Existing and Proposed Bicycle Network	15
Figure 6 Project Trip Distribution and Trip Assignment	22
Figure 7 Existing plus Project Peak Hour Traffic Volumes	23

Appendices

Appendix A	Detailed Project Site Plans
Appendix B	AM and PM Peak Hour Intersection Turning Movement Counts
Appendix C	Existing Conditions LOS and Queue Length Calculations
Appendix D	Detailed Project Trip Generation Calculations
Appendix E	Existing plus Project Conditions LOS and Queue Length Calculations
Appendix F	Detailed Project-Generated Vehicle Miles Traveled (VMT) Calculations

1.0 Introduction

This study provides an evaluation of potential traffic and transportation impacts associated with construction of the proposed Aramis Solar Energy Generation and Storage Project (Project) in unincorporated Alameda County. This analysis is based on Project plans dated June 19, 2020, Project Sponsor construction data, and CHS Consulting Group (CHS) collected field data. The purpose of the transportation impact study is to inform the Project environmental review. The following Project impact analysis topics are addressed in this study:

- Level of Service (LOS) traffic operations (for informational purposes only);
- Vehicle Miles Traveled (VMT);
- Transit;
- Walking; and
- Bicycling.

1.1 Project Location and Site

The Project site is located in unincorporated Alameda County on portions of four privately-owned parcels (APNs 903-0006-001-02 [eastern 350 acres of a 536 acre parcel], 903-0007-002-01), 903-0006-003-07, and 902-0001-005-00) approximately 2.5 miles north of the City of Livermore.

The Project site and surrounding areas are zoned “A” (Agriculture). The site is currently cultivated and grazed and does not contain any structures. Uses of surrounding properties include grazing, electric utilities, intensive agriculture, estate and rural residential uses, and plant and animal habitat associated with Cayetano Creek, an intermittent waterway. Proposed nearby land uses include a solar photovoltaic development proposed by an unrelated applicant.

Figure 1 shows the Project location and vicinity.

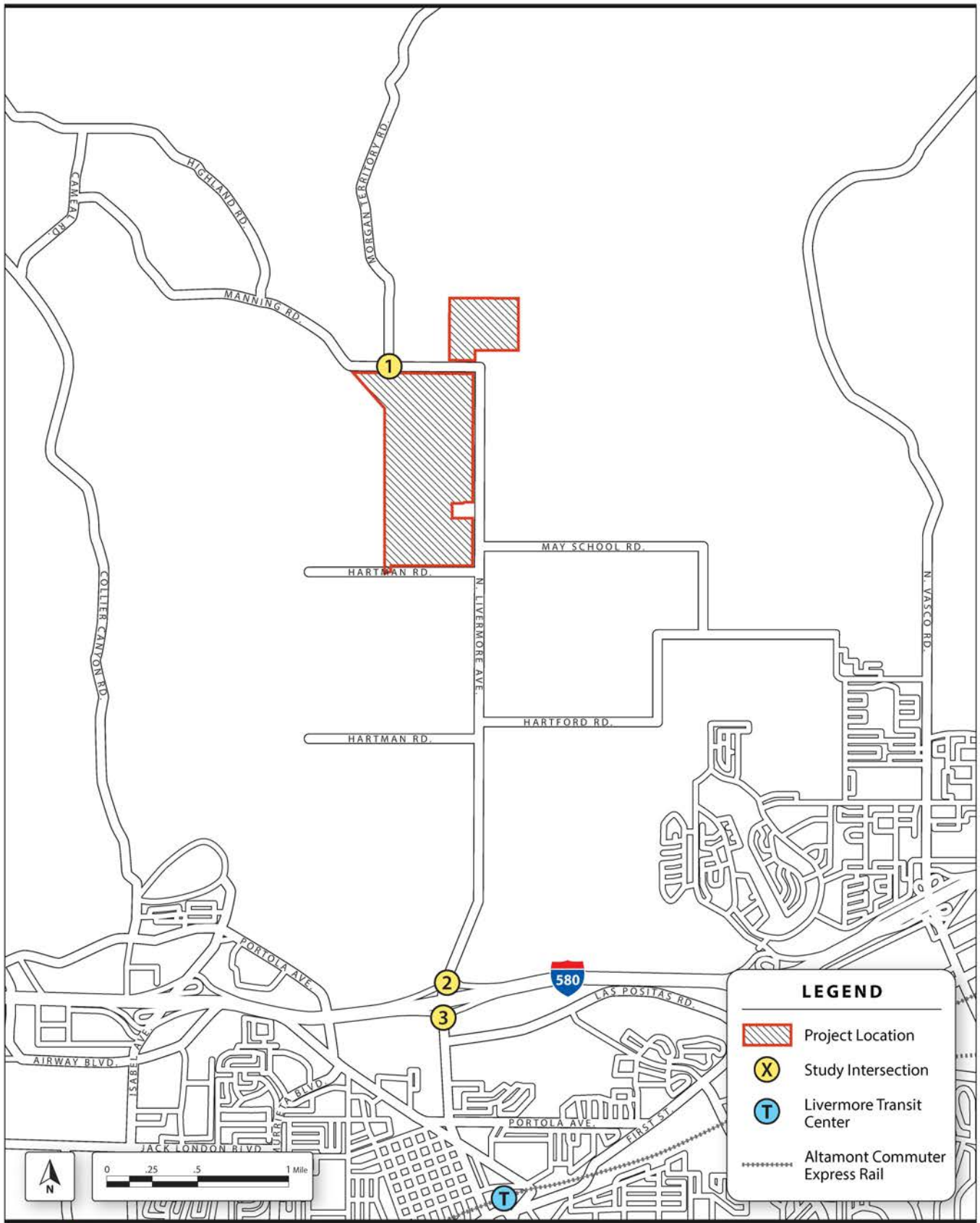

Aramis Renewable Energy Project Transportation Impact Study

1.2 Project Description

The Project would consist of the construction and operation of a solar energy generation and storage facility within a 410-acre development footprint located in unincorporated Alameda County about two miles north of the Livermore city limits and Interstate I-580, primarily on the west side of North Livermore Avenue, and extending about two miles further north, including portions about a half mile north of the terminus of North Livermore Avenue at Manning Road.

The Project would generate 100 megawatts (MWs) of photovoltaic power with an interconnect to the public distribution system at Pacific Gas and Electric Company's (PG&E) Cayetano 230 kilovolt (kV) substation located adjacent to the Project site. The Project would serve East Bay Clean Energy (EBCE) or PG&E customers by providing local generation capacity under a long-term contract.

The Project facility would be comprised of photovoltaic modules connected in strings mounted onto a single-axis tracker racking system, which would in turn be affixed to steel piles. The module strings would track the sun during the day, from east to west, to optimize power generation of the facility. Modules would be connected by low-voltage underground or above-ground electrical wiring to a central inverter station or to string inverters located throughout the facility.

A newly constructed Project substation would be located adjacent to the PG&E Cayetano Substation, allowing the gen-tie (energy generation link to the PG&E substation) to be short and overhead with a possibility of underground construction as well. Overhead lines would be constructed on either tubular steel poles or wood H-Frames and may be constructed to be single-circuit or double-circuit. The heights of the overhead poles could vary from 30 to 100 feet.

The duration of Project construction would be approximately nine months, beginning with installation of interconnection facilities, followed by site preparation activities, cable installation, pile and skid installation, and finishing with tracker and module installation and site cleanup. Project construction would be completed in four phases, including Phase 1 site preparation (30 days), Phase 2 photovoltaic installation (150 days), Phase 3 electrical and gen-tie installation (75 days), and Phase 4 general construction operations and site clean-up and restoration (175 days). Phase 4 spans the entire construction duration. It is anticipated that construction Phases 2, 3, and 4 would overlap for approximately 10 weeks duration. According to the Project Sponsor, work for all phases would be conducted Monday through Friday between the hours of 8 a.m. and 5 p.m.

Access to the Project site would be provided via all-weather, rocked driveway aprons at four access points along North Manning Road, two access points along North Livermore Avenue, and one access point along Hartman Road. The primary internal access roads would be designed by a licensed civil engineer to ensure all-weather access by emergency response vehicles, including large fire apparatus. The primary access roads would be designed to be 16 feet wide. Banked corners and periodic three-point turnaround locations would ensure that large fire trucks may navigate the site safely. The narrower, inter-array pathways would be constructed of compacted dirt and be accessible by smaller maintenance vehicles.

Once Project construction is complete and the facilities are in full operation, up to four permanent staff could be onsite at a time for ongoing facility maintenance and repairs and up to 12 workers could be onsite once annually for module washing. Personnel and time required for emergency maintenance would vary in accordance with the necessary response.

Figure 2 presents the Project site layout. Detailed Project site plans are provided in **Appendix A**.

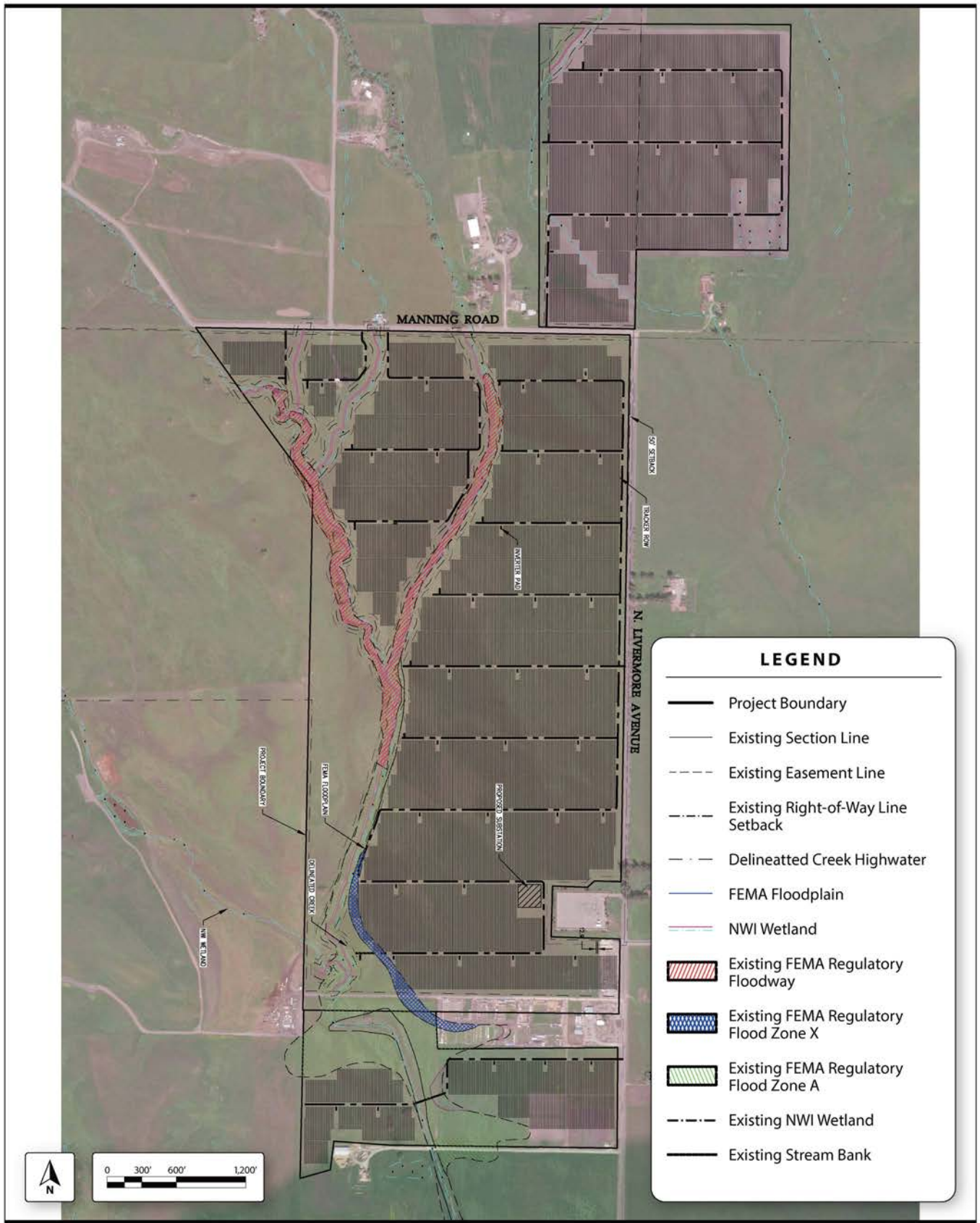

Aramis Renewable Energy Project Transportation Impact Study

1.3 Study Scope and Approach

The scope of this transportation study includes analysis of impacts under the following two scenarios:

- Existing Conditions – this scenario represents current traffic and transportation conditions prior to commencement of Project construction.¹
- Existing plus Project Conditions – this scenario is identical to Existing Conditions, but with the addition of Project-generated construction traffic.

Typically, most transportation studies focus on impacts after a project is constructed and in operation, as the expected traffic generation once in operation is usually higher than that generated under any construction phase or combination of phases. For this Project, however, the reverse is true. Once the Project is in operation, an average of four workers would be onsite each weekday and up to 12 workers would access the site once annually for scheduled module washing, which would result in daily vehicle volumes below any threshold of measurable or adverse effect. As such, this study focuses on construction-related impacts.

Given the minimal traffic that would be generated by the Project on a daily basis once in operation, the study focuses only on near-term impacts, and as such, no cumulative year analysis has been conducted. Project-generated VMT was evaluated for the purposes of traffic analysis consistent with CEQA Guidelines Appendix G. Additionally, study intersections were evaluated using the *2000 Highway Capacity Manual* operations methodology to determine potential Project effects on local traffic operations during construction for informational purposes.² Project trips were estimated based on a Project Sponsor-provided construction program that estimates the maximum number of construction truck haul trips and worker trips based on overlapping phases during construction. Trip distribution was based on Project Sponsor-anticipated commute origins of Project contractors and origin/destination data for construction truck haul trips.

The following three intersections were analyzed for this study, which CHS developed in coordination with County Staff and is based on experience with the study area and the Project Sponsor-anticipated origins and routes of construction worker and truck trips:³

1. Morgan Territory Road / Manning Road
2. North Livermore Avenue / I-580 Westbound Ramps
3. North Livermore Avenue / I-580 Eastbound Ramps

¹ Note: The field analysis for this study was completed prior to the initiation of state and local health official orders to Shelter-in-Place due to the Covid-19 pandemic, which has generally resulted in lower traffic volumes both locally and regionally. The volumes used in this study therefore represent worst-case pre Covid-19 pandemic conditions.

² The *2000 Highway Capacity Manual* (HCM) operations methodology was used for the purposes of this study because of a limitation in the *2010 HCM* methodology. The *2010 HCM* methodology cannot calculate delay for turning movements with shared and exclusive lanes, which includes the study intersections of North Livermore Avenue and the I-580 westbound and eastbound ramps. For consistency, the *2000 HCM* methodology was used for all study intersections.

³ Based on discussions with County Staff it is noted that Hartford, Lorraine, and Raymond roads are used as alternative “cut-through” traffic routes between I-580 and the Springtown neighborhood in Livermore. However, these traffic volumes have been captured at the above study intersections.

2.0 Existing Conditions

This section describes the existing transportation conditions in the Project area, presented in **Figure 1**, p. 2. The existing setting includes descriptions of the roadways and documentation of existing vehicular traffic, local and regional transit service, pedestrian, and bicycle access conditions.

2.1 Roadway Network

The following includes a discussion of existing roadways in the vicinity of the Project. The functional designation of each roadway was obtained from the *Alameda County General Plan (General Plan)*⁴ and the *East County Area Plan (ECAP)*.⁵

The Alameda County roadway system is comprised of freeways, arterials, collector, and local streets. The *General Plan* defines freeways as high-speed, high-capacity transportation facilities serving regional and countywide travel; arterials as high mobility, high-capacity roadways that provide access to regional transportation facilities, accommodate intra-community travel, and connect the rest of the countywide collector system; collectors as low-speed, low-volume streets with two lanes that provide for circulation within and between neighborhoods, and support relatively short trips and are meant to collect vehicles from local streets and distribute them to the arterial network; and local streets as roadways that provide access to individual properties, primarily residences and businesses, and connect to the County's network of arterial and collector streets.

2.1.1 Regional Access

Interstate 580 (I-580) is an eight- to ten-lane east-west freeway that runs from the San Francisco-Oakland Bay Bridge, traveling through the Eden Area in Ashland, before turning east to Castro Valley, Livermore, and the Central Valley. Access to I-580 from the Project site is provided via North Livermore Avenue (approximately two miles south of the Project site).

2.1.2 Local Access

Local access is provided by several local roadways in proximity to the Project site, all designated as collector roadways in the *ECAP*. Descriptions of these roadways are presented below.

North Livermore Avenue is a north-south roadway that runs from Manning Road to I-580 and continues south through downtown Livermore to Tesla Road in the south Livermore area. In the vicinity of the Project site, this roadway operates with one travel lane in each direction. On-street parking is prohibited at all times along both sides of the roadway. Class II bike lanes are provided on both sides of the street, between Manning Road and the I-580 westbound ramps. The *General Plan* identifies North Livermore Road as an arterial roadway within the Livermore city limits and as a collector route north of I-580.

⁴ *Alameda County General Plan Annual Report for 2017*

⁵ *East County Area Plan, A Portion of the Alameda County General Plan, Volume 1, May 2002*

May School Road is an east-west roadway that extends eastward from North Livermore Avenue, and connects in sequence to Dagnino and Raymond Roads, Ames Street and Dalton Avenue, by which vehicles can connect to Vasco Road, an expressway connecting the Tri-Valley area to eastern Contra Costa County. Hartford Avenue and Lorraine Street functionally parallel the connection of May School and Dagnino Roads to Raymond Road about a mile to the south.

Manning Road is an east-west roadway that extends westward from the terminus of North Livermore Avenue to various roads that lead into Contra Costa County and a mixture of farms, estate properties and other agricultural uses in both Alameda and Contra Costa Counties, served by Morgan Territory, Highland, Collier Canyon and Carneal Roads. Camino Tassajara and the rural residential community of Tassajara in Contra Costa County is approximately six miles west of the North Livermore Avenue terminus.

Morgan Territory Road is a north-south roadway that runs from Manning Road to Marsh Creek Road. In the vicinity of the Project site, this roadway operates with one travel lane in each direction. There are no pedestrian or bicycle facilities provided on Morgan Territory Road. The *General Plan* identifies Morgan Territory Road as a collector street.

There are no pedestrian facilities on any of the local roads and the bike lane on North Livermore Avenue is the only Class II bicycle facility in the area. Manning, May School, Hartford and Collier Canyon roads are designated as Class III rural routes in the *Alameda County Bicycle and Pedestrian Master Plan for Unincorporated Areas*.⁶

2.2 Intersection Traffic Volumes

The three study intersections were counted on Thursday, February 26, 2020 during weekday a.m. (7-9 a.m.) and p.m. (4-6 p.m.) peak periods. The intersections and their traffic controls are listed below. Collected vehicle, bicycle, and pedestrian volumes for the weekday a.m. and p.m. peak periods are presented in **Appendix B**.

1. Morgan Territory Road / Manning Road (One-Way Stop Controlled)
2. North Livermore Avenue / I-580 Westbound Ramps (Signalized)
3. North Livermore Avenue / I-580 Eastbound Ramps (Signalized)

Figure 3 presents existing lane configurations and weekday a.m. and p.m. peak hour vehicle turning movements for the study intersections.

⁶ Public Works Agency, 2012, as updated through 2019.

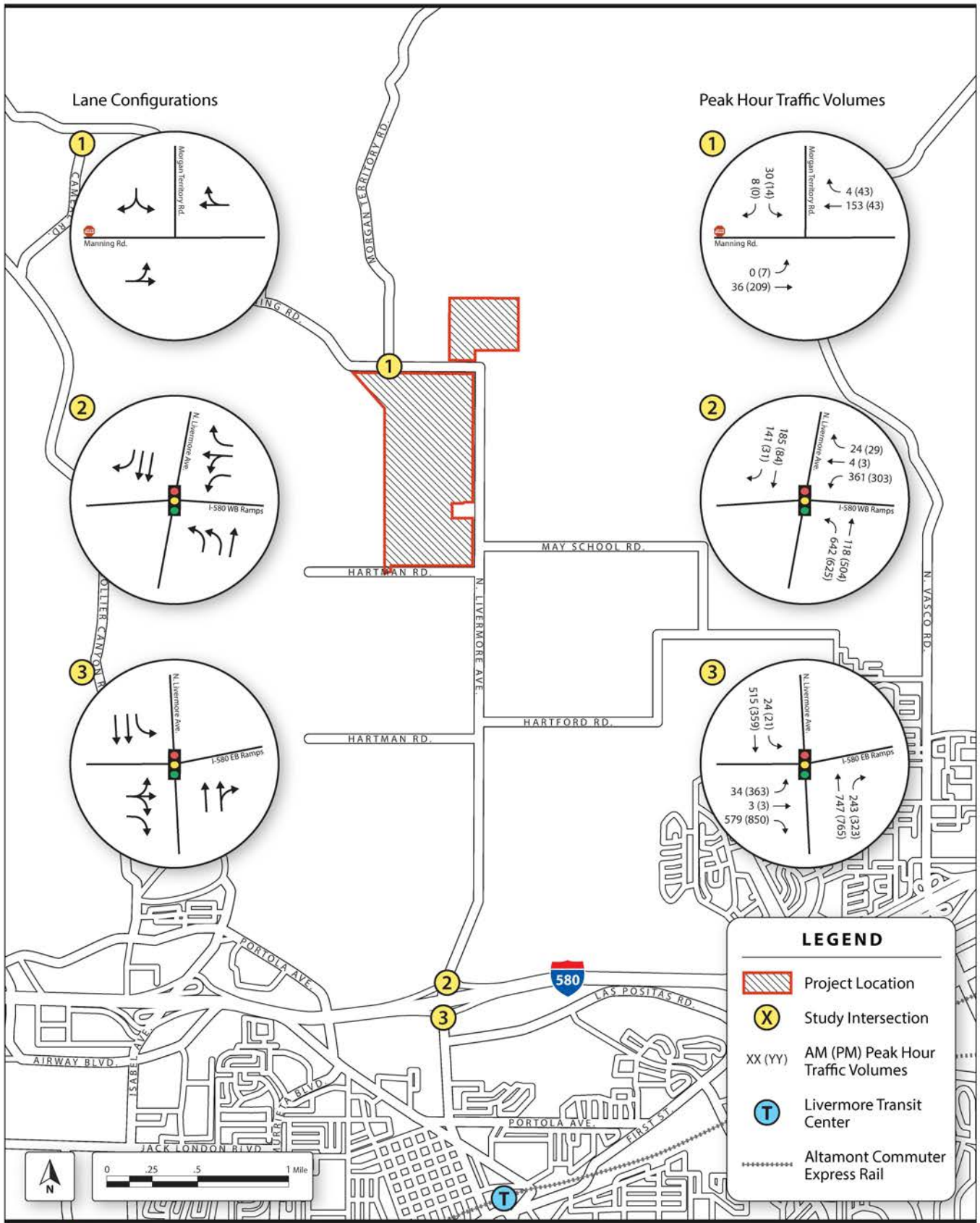

Aramis Renewable Energy Project Transportation Impact Study

Figure 3
Existing Conditions Lane Configurations
and Peak Hour Traffic Volumes

2.3 Level of Service Methodology

Traffic operational level of service (LOS) conditions were evaluated for traffic during weekday a.m. (7-9 a.m.) and p.m. (4-6 p.m.) peak periods and is provided for informational purposes only. LOS is a qualitative description of an intersection’s performance based on the average delay per vehicle. Intersection LOS range from LOS A, which indicates free flow conditions with minimal delays, to LOS F, which indicates congested conditions with considerably long delays.

The study intersections were evaluated using the *2000 Highway Capacity Manual* operations methodology. This method determines the capacity for each directional approach to an intersection. LOS is calculated based on the average stopped delay (seconds per vehicle) for the various approaches at the intersection. For signalized intersections, CHS additionally incorporated current Caltrans signal timing cards.⁷

2.4 Level of Service Analysis – Existing Conditions

Table 1 presents the LOS and delay analysis results for the study intersections during the weekday a.m. and p.m. peak hours under Existing Conditions. Existing Conditions intersection LOS calculations are provided in **Appendix C**. As shown in **Table 1**, all the study intersections are currently operating at LOS C or better under Existing Conditions.

Table 1: Existing Conditions: Peak Hour Intersection Level of Service Results

Intersection	Control Type	AM Peak Hour		PM Peak Hour	
		Delay	LOS	Delay	LOS
1. Morgan Territory Rd. / Manning Rd.	One-Way Stop Controlled	9.9	A	10.7	B
2. North Livermore Ave. / I-580 WB Ramps	Signalized	16.9	B	16.5	B
3. North Livermore Ave. / I-580 EB Ramps	Signalized	10.7	B	26.6	C

Source: CHS Consulting Group, 2020

Notes:

1. Delay reported as seconds per vehicle. For signalized and all-way stop controlled intersections, a weighted average delay and level of service (LOS) based on all intersection approaches is reported. For unsignalized intersections (1-way and 2-way stop controlled), delay and LOS for the worst stop-controlled approach is reported.
2. WB = westbound; EB = eastbound; LOS = Level of Service

2.5 95th Percentile Vehicle Queue Length Analysis – Existing Conditions

Peak hour 95th percentile queue lengths were also reviewed and compared with the existing storage capacity of turn lanes at study intersections where Project-generated traffic is expected to be added, including the southbound right-turn lane at the North Livermore Avenue and I-580 westbound ramp intersection and southbound left-turn and eastbound shared left, through, and right-turn lane at the North Livermore Avenue and I-580 eastbound ramp intersection. Existing a.m. and p.m. peak hour intersection queue analysis results are summarized in **Table 2**, which shows that the 95th percentile vehicle queue lengths at study intersections

⁷ Signal timing cards provide the complete timing program for signalized traffic intersections that establish the sequence of operation and amount of time allocated to each intersection approach while considering time for pedestrians and other users.

are currently accommodated within existing storage capacity for both peak hours under Existing Conditions. Furthermore, field analysis for this study was completed prior to the Shelter-in-Place order due to the Covid-19 pandemic that has resulted in substantially lower traffic volumes both locally and regionally, and thus represents a conservative worst-case condition that may not reflect actual conditions at the time of construction.

Table 2: Existing Conditions: Peak Hour Intersection Queue Analysis Results

Intersection	Turn Lane	Storage Capacity (feet)	95th Percentile Queue Length (feet)	
			AM Peak Hour	PM Peak Hour
North Livermore Ave. / I-580 WB Ramps	SBR	140	40	0
North Livermore Ave. / I-580 EB Ramps	EBLTR	530	66	454
	SBL	240	16	8

Source: CHS Consulting Group, 2020

Notes:

1. Results for the a.m. peak hour queue analysis can be reasonably expected based on field observations of existing a.m. peak hour vehicle queues conducted on Thursday, February 26, 2020 (pre-COVID shelter in place orders).
2. Bold text indicates 95th percentile queue length exceeds existing turn pocket capacity
3. WB = westbound; EB = eastbound; EBLTR = eastbound shared left, thru, right lane; SBL = southbound left-turn lane; SBR = southbound right-turn lane

2.6 Vehicle Miles Traveled (VMT) – Existing Conditions

Vehicle miles traveled (VMT) is a measurement of miles traveled by vehicles within a specified region for a specified time period.⁸ The Project site is located in a rural setting and the site itself is currently used for agricultural cultivation and grazing. As such, the Project site generates minimal vehicle trips and proportionally minimal VMT that cannot be feasibly quantified.

2.7 Transit Conditions

The Project site is not currently served by local public transit service, nor is any such service anticipated to be established in the area in the foreseeable future. The Livermore–Amador Valley Transit Authority (LAVTA) operates the WHEELS bus service, which provides local public transit to the cities of Dublin, Livermore, Pleasanton, and unincorporated areas of Alameda County. LAVTA also provides connecting service to Bay Area Rapid Transit (BART), Altamont Commuter Express (ACE), and Central Contra County Transportation Authority (County Connection). The closest WHEELS route, Route 580X, operates through two study intersections (North Livermore Avenue / I-580 eastbound ramps and North Livermore Avenue / I-580 westbound ramps). The nearest transit stops are located on North Livermore Avenue just south of the intersection with Las Positas Road (approximately 2.2 miles south of the Project site), no bus stops directly serve the Project site. Route 580X operates two-way express service between 5:57 a.m. and 8:26 a.m., and between 4:29 p.m. and 7:28 p.m. with 30-minute headways. This route provides service between the Livermore Transit Center and East Dublin / Pleasanton BART Station. **Figure 4** presents the transit lines and bus stop locations within the Project area.

⁸ Source: Alameda County Congestion Management Program, September 2019

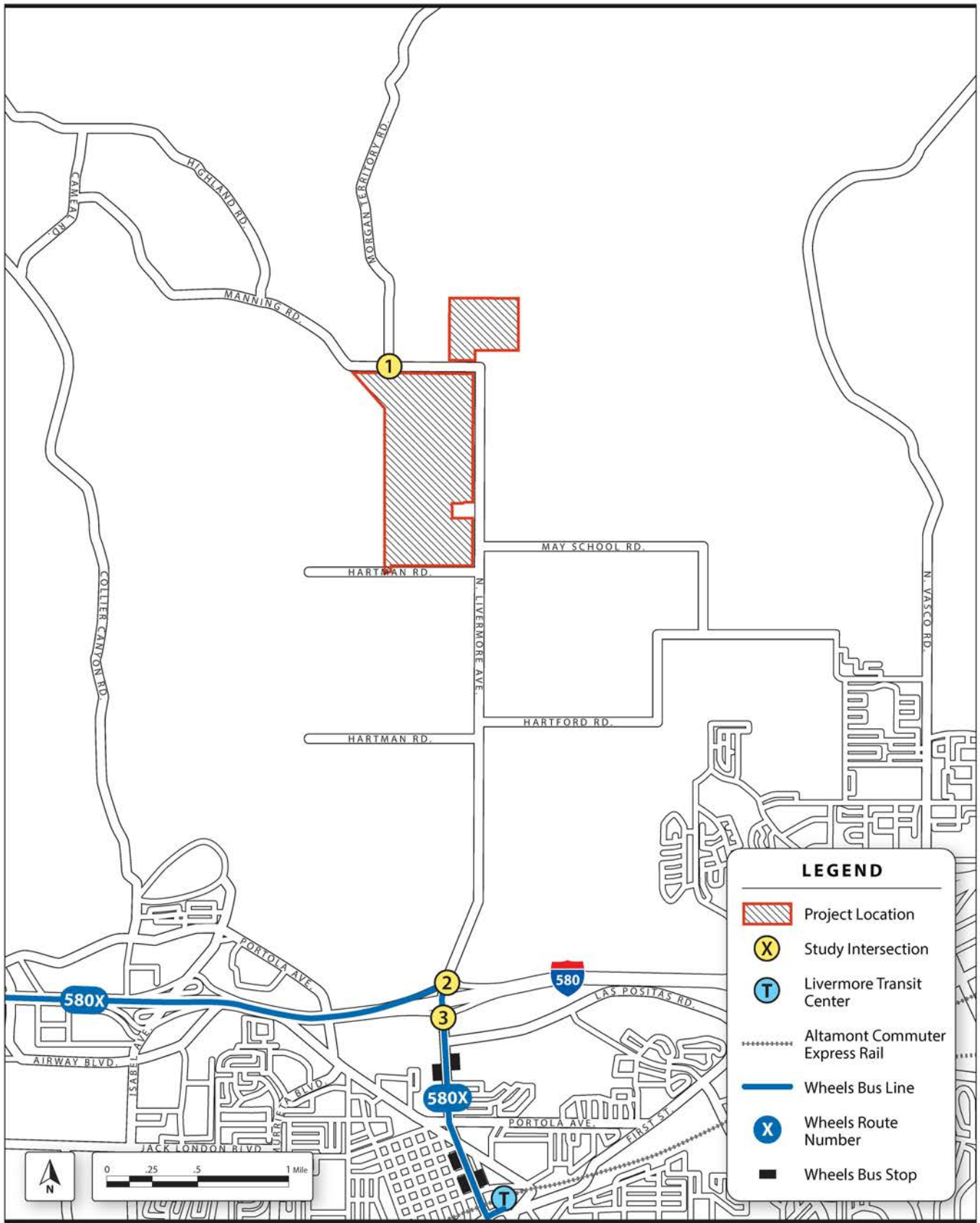

LEGEND

-  Project Location
-  Study Intersection
-  Livermore Transit Center
-  Altamont Commuter Express Rail
-  Wheels Bus Line
-  Wheels Route Number
-  Wheels Bus Stop

Aramis Renewable Energy Project Transportation Impact Study

Figure 4
Existing Transit Network

2.8 Walking/Accessibility Conditions

The Project site is located in a rural setting in unincorporated Alameda County. Generally, there are no pedestrian facilities surrounding the Project site or at any of the study intersections in the Project vicinity. Such facilities may include pedestrian crosswalks, curb-ramps, and pedestrian signal heads.

CHS collected pedestrian counts at each study intersection on Thursday, November 7, 2019 during the a.m. (7-9 a.m.) and p.m. (4-6 p.m.) peak periods (see **Appendix B**). Indicative of the rural Project vicinity, existing peak hour pedestrian volumes are generally very low, with three during the a.m. peak hour and two during the p.m. peak hour at the Morgan Territory / Manning intersection. No pedestrian crossings were observed at the intersections of North Livermore Avenue and the I-580 ramps.

2.9 Bicycle Conditions

Bicycle facilities include bicycle lanes, trails, and paths. On-street bicycle facilities include the following classifications:

Class I Bikeways - Shared-use paths with two-way paved facilities, physically separated from vehicular traffic for use by bicyclists, pedestrians, or other non-motorized users; and includes trails that are unpaved paths accessible by bicycles and pedestrians, which are not considered accessible by Americans with Disabilities Act (ADA) standards.

Class II Bikeways - Bike lanes striped within the paved areas of roadways and established for the exclusive use of bicycles; and includes buffered bicycle lanes that provide an additional painted buffer between the striped bicycle lane and adjacent travel lane.

Class III Bikeways - Signed bicycle routes that allow bicycles to share travel lanes with vehicles on low-speed residential and rural roadways where bicyclists have priority.

Class IV Separated Bikeways - On-street bike facilities that are physically separated from traffic by curbs, plant boxes, bollards, grade separation, or parked cars for exclusive right-of-way for use by bicyclists.

Existing Bikeways

According to the *Alameda County Bicycle and Pedestrian Master Plan for Unincorporated Areas (Bike Plan)*⁹, unincorporated Alameda County currently has approximately 65.8 miles of bikeways including Class I (4.4 miles), Class II (40.8 miles), Class III (20.6 miles). There are currently no Class IV bikeways in unincorporated Alameda County.

Adjacent to the Project site, there are Class II bike lanes that run in both the north and south directions along North Livermore Avenue, beginning north of Cayetano Court (north of I-580) and ending at Manning Avenue. There are no other existing bikeways in proximity to the Project site. Indicative of the minimal area bicycle

⁹ Source: *Alameda County Bicycle and Pedestrian Master Plan for Unincorporated Areas*, Draft Plan, September 2019

facilities, no a.m. and p.m. peak hour bicycle trips were observed at the study intersections (see **Appendix B**). However, it is noted that bicycle routes in the study area would typically not serve a conventional bicycle commuter function, but primarily are intended for recreational and inter-regional access routes. As a result, bicycle traffic on study roadways are typically higher during the weekends and outside of the typical weekday peak commute periods. Furthermore, the area is host to several annual spring, summer, and fall bicycle touring, racing, and charity events that use these rural bike routes.

Future Bikeway Improvements

In terms of future bikeways, the *Bike Plan* recommends an additional 200 miles of bicycle facilities that would increase the system-wide total mileage of bikeways to 265.9 miles, including Class I shared use paths (32.2 miles), Class II bike lanes (58.9 miles), Class III bike routes (164.8 miles), and Class IV separated bikeways (10 miles).

South of the Project site, future Class III bike routes are proposed along Hartford Avenue, May School Road, and Manning Avenue. Further south, the *Livermore Bicycle, Pedestrian, and Trail Active Transportation Plan (Livermore Active Transportation Plan)*¹⁰ proposes Class II bike lanes along North Livermore Avenue, between the I-580 westbound ramps and Las Positas Road.

Figure 5 shows the location of existing and proposed bikeways near the Project site.

¹⁰ Source: Livermore Bicycle, Pedestrian, and Trails Active Transportation Plan, June 2018

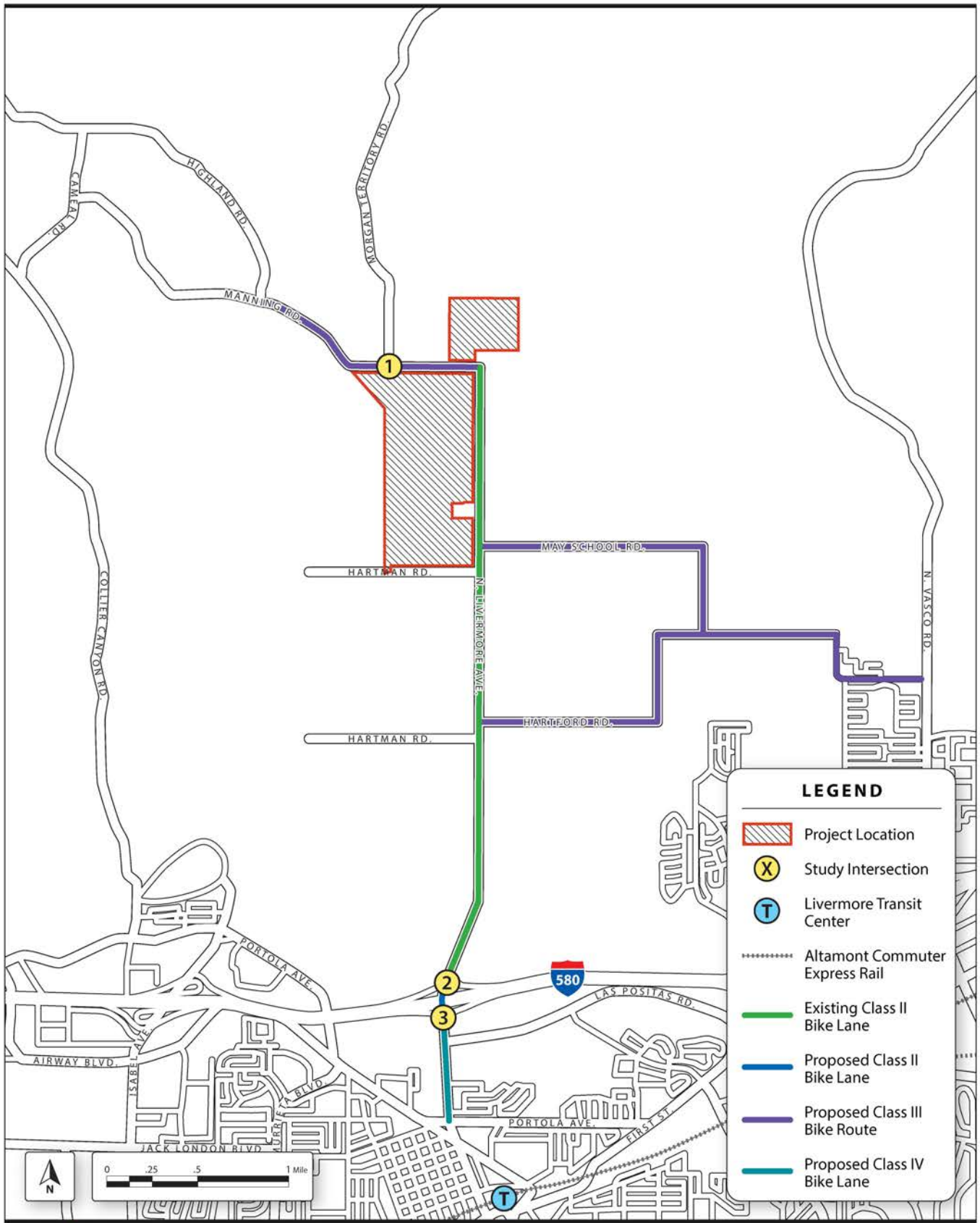

Aram Renewable Energy Project Transportation Impact Study

3.0 Regulatory Setting

3.1 Alameda County

The ECAP contains goals and policies to maintain an efficient circulation network in the eastern portion of Alameda County. These goals include creating and maintaining a balanced multimodal transportation system, cooperating with other regional transportation planning agencies, integrating pedestrian infrastructure into the transportation system, and mitigating exceedances of LOS standards. The ECAP standard for major intercity arterials is LOS D or better, which includes the Project study intersection of Manning Road and Morgan Territory Road. Alameda County has not established designated local truck routes nor adopted specific policies regarding management of construction activities.

In 2013, the State of California passed Senate Bill (SB) 743, transitioning from automobile delay (commonly measures by LOS) to VMT in transportation analysis under the California Environmental Quality Act (CEQA). It should be noted that SB 743 requires CEQA lead agencies to eliminate the use of vehicular LOS as the primary transportation metric. Therefore, LOS analysis is presented for informational purposes only. The California Governor's Office of Planning and Research (OPR) has mandated that all CEQA lead agencies adopt a new VMT transportation metric by July 1, 2020. Alameda County, the CEQA lead agency for this Project, is currently in the process of transitioning to the VMT metric.

3.2 Alameda County Transportation Commission (Alameda CTC)

The Alameda County Transportation Commission (Alameda CTC) is a joint powers authority that plans, funds and delivers transportation programs and projects that expand access and improve mobility to foster a vibrant and livable Alameda County. It was formed in 2010 from the merger of the Alameda County Transportation Improvement Authority and the Alameda County Congestion Management Agency.

As required by state law, Alameda CTC updates its Congestion Management Program (CMP) every two years by monitoring the operational performance of the designated County CMP road network. The current CMP was adopted in September 2019. The Alameda CTC is currently in the process of transitioning to VMT as the primary metric for traffic impacts. Until this transition is complete and resolved through amended CMP legislation, the Alameda CMP minimum standard for monitored roads and freeways in the CMP network of LOS E remains the agency's transportation metric and as such is applied to this study. The study intersections include two County CMP network roadways, North Livermore Avenue and I-580.

It is noted that Alameda CTC CMP standards and travel demand measures are focused on traffic impacts associated with future development, and as such do not apply to construction activities such as the Project in which there are temporary, short-term traffic increases that are eliminated once construction is completed.

3.3 California Department of Transportation (Caltrans)

The California Department of Transportation (Caltrans) is a state agency overseeing state highway, bridge, and rail transportation planning, construction, maintenance and operation. Caltrans' 2002 Guide for the Preparation of Traffic Impact Studies provides the fundamental criteria and guidelines for conducting such studies. In terms of state highway LOS standards, Caltrans "endeavors to maintain a target LOS at the transition between LOS 'C' and LOS 'D'... on State highway facilities." (California Department of Transportation 2002:1). However, Caltrans recognizes that this may not always be feasible and invites lead agencies to consult with the agency to determine appropriate levels of service for particular state highway facilities. It should also be noted that the study intersections of North Livermore Avenue and the I-580 eastbound and westbound ramps are under Caltrans jurisdiction.

3.4 Project Study Transportation Metric

Based on the preceding criteria and for informational purposes only, the *Area Plan* LOS standards for major intercity arterials of LOS D or better apply to the study intersection of Manning and Morgan Territory roads, and the Alameda County CMA standards for key roads and freeways in the CMP network of LOS E or better apply to the study intersections of North Livermore Avenue and I-580 westbound ramps and North Livermore Avenue and I-580 eastbound ramps.

3.5 State Significance Criteria (CEQA)

Based on the CEQA Guidelines Appendix G, the Project would result in a significant impact on transportation and traffic if it would:

- a. Conflicts with a plan, ordinance, or policy addressing the circulation system, including transit, roadway, bicycle, and pedestrian facilities.
- b. Conflicts, or be inconsistent, with CEQA Guidelines section 15064.3, subdivision (b)(1).¹¹
- c. Substantially increases hazards due to a geometric design feature (e.g. sharp curves or dangerous intersections) or incompatible uses (e.g., farm equipment).
- d. Results in inadequate emergency access.

¹¹ CEQA Guidelines section 15064.3, subdivision (b)(1), establishes that VMT exceeding an applicable threshold of significance may indicate a significant impact. Generally, projects within one-half mile of either an existing major transit stop or a stop along an existing high-quality transit corridor should be presumed to cause a less than significant transportation impact. Projects that decrease vehicle miles traveled in the project area compared to existing conditions should be presumed to have a less than significant transportation impact.

4.0 EXISTING PLUS PROJECT CONDITIONS

This section presents analysis results for Existing plus Project Conditions, which is identical to Existing Conditions but with added traffic from Project construction activities.

4.1 Project Trip Generation

CHS developed Project vehicular trip generation based on Project Sponsor-provided data on proposed construction activities. Specific data used include the anticipated construction schedule, maximum number of workers onsite during each construction phase, and truck haul trips required to complete each phase. As discussed in Section 1.2, the Project would be constructed over a nine-month period and generally completed in four phases. The peak of construction activity is anticipated occur when Phases 2, 3, and 4 overlap for approximately 50 days. Worker vehicle trips and truck haul trips are estimated separately as they represent distinct trip types. Detailed Project trip generation calculations are provided in **Appendix D**.

4.1.1 Worker Trips

The total number of daily construction workers will vary depending on the specific phases and their overlap. Based on confirmation with the Project Sponsor, construction workers are expected to generate approximately four trips per person on a daily basis, including two commute trips (one a.m. peak hour inbound and one p.m. peak hour outbound) and two auxiliary trips (one inbound and one outbound) during the midday for offsite trips. For conservative (worst-case) calculation purposes and given the lack of transit access to the site, it was assumed that all workers would drive alone. **Table 3** shows the maximum number of workers anticipated on-site per day during each construction phase.

Table 3: Worker Trips by Construction Phase

Construction Phase	Maximum Workers Onsite	Worker Trips						
		Daily	AM Peak Hour			PM Peak Hour		
			Inbound	Outbound	Total	Inbound	Outbound	Total
Phase 1	100	400	100	0	100	0	100	100
Phase 2	250	1,000	250	0	250	0	250	250
Phase 3	125	500	125	0	125	0	125	125
Phase 4 ¹	0	0	0	0	0	0	0	0
Peak Construction²	375	1,500	375	0	375	0	375	375

Source: IP Aramis, LLC; CHS Consulting Group, 2020

Notes:

1. No additional worker trips are expected for Phase 4, as all Phase 4 activities would use available workers associated with Phases 1, 2, and 3.
2. Peak construction includes the overlap of Phases 2, 3, and 4 for up to 50 days in duration.

As shown in **Table 3**, during the peak overlap of Phases 2, 3, and 4, up to 375 workers would be on-site during a typical workday. This would equate to approximately 1,500 daily worker trips, including 375 trips inbound during the a.m. peak hour and 375 trips outbound during p.m. peak hour.

4.1.2 Truck Haul Trips

Similar to worker trips, the total number of truck haul trips generated at the Project site will vary depending on the construction phase and any overlap. The Project Sponsor provided CHS with the maximum expected truck haul trips required during each construction phase. Based on confirmation with the Project Sponsor, trucks would deliver construction materials and remove refuse material from the site on a continual basis on weekdays from 8 a.m. to 5 p.m. with an even 50/50, inbound/outbound split each hour. Based on these assumptions, the maximum number of truck haul trips were divided by the total number of workdays in each phase to estimate the maximum daily trips for each phase. **Table 4** shows the maximum number of daily truck haul trips to/from the Project site during each construction phase.

Table 4: Truck Haul Trips by Construction Phase

Construction Phase	Truck Haul Trips						
	Daily	AM Peak Hour			PM Peak Hour		
		Inbound	Outbound	Total	Inbound	Outbound	Total
Phase 1	46	3	2	5	2	3	5
Phase 2	52	3	3	6	3	3	6
Phase 3	10	1	1	2	1	1	2
Phase 4	59	3	3	6	3	3	6
Peak Construction¹	121	7	7	14	7	7	14

Source: Intersect Power; CHS Consulting Group, 2020

Notes:

1. Peak construction includes the overlap of Phases 2, 3, and 4 for up to 50 weeks duration.

As shown in **Table 4**, during the peak overlap of Phases 2, 3, and 4, up to 121 daily truck haul trips would be generated, including 14 trips (seven inbound and seven outbound) during both the a.m. and p.m. peak hours.

4.1.3 Composite of Project Trips

To estimate the maximum number of total Project trips, the preceding trip generation analysis of worker and truck haul trips were combined to estimate the maximum number of total trips per phase for use in the subsequent traffic analysis. **Table 5** shows the composite maximum number of trips to/from the Project site during each construction phase.

Table 5: Total Project Trips by Construction Phase

Construction Phase	Trip Type	Daily Trips	AM Peak Hour			PM Peak Hour		
			Inbound	Outbound	Total	Inbound	Outbound	Total
Phase 1	Worker	400	100	0	100	0	100	100
	Truck	46	3	2	5	2	3	5
	Total	446	103	2	105	2	103	105
Phase 2	Worker	1,000	250	0	250	0	250	250
	Truck	52	3	3	6	3	3	6
	Total	1,052	253	3	256	3	253	256
Phase 3	Worker	500	125	0	125	0	125	125
	Truck	10	1	1	2	1	1	2
	Total	510	126	1	127	1	126	127
Phase 4 ¹	Worker	0	0	0	0	0	0	0
	Truck	59	3	3	6	3	3	6
	Total	59	3	3	6	3	3	6
Peak Construction ²	Worker	1,500	375	0	375	0	375	375
	Truck	121	7	7	14	7	7	14
	Total	1,621	382	7	389	7	382	389

Source: IP Aramis, LLC; CHS Consulting Group, 2020

Notes:

1. No additional worker trips are expected for Phase 4, as all Phase 4 activities would use available workers associated with Phases 1, 2, and 3.
2. Peak construction includes the overlap of Phases 2, 3, and 4 for up to 50 days in duration.

As shown in **Table 5**, during the peak overlap of Phases 2, 3, and 4, up to 1,621 trips would be generated (1,500 worker and 121 truck haul trips), including 389 trips (382 inbound and seven outbound) during the a.m. peak hour and 389 trips (seven inbound and 382 outbound) during the p.m. peak hour.

4.2 Project Trip Distribution and Assignment

The Project Sponsor provided CHS with specific worker home-origin data based on the home locations of anticipated construction contractors, which assumes that the Project workforce trips would primarily originate in the cities of Oakland, San Leandro, Hayward, Fremont, and Tracy. To estimate the proportion of construction workers arriving from each of the five East Bay cities, the US Census Bureau’s 2018 American Community Survey (ACS) data was used to calculate the proportion of construction workers residing in each city. **Table 6** shows that most construction workers would come from Oakland (42 percent), followed by Hayward (20 percent), Tracy (15 percent), Fremont (12 percent) and San Leandro (11 percent).

Table 6: Distribution of Project Construction Workers by Origin City

Origin City	Construction Worker Population	Proportion of Workers (%)
Oakland	13,727	42
San Leandro	3,740	11
Hayward	6,441	20
Fremont	3,872	12
Tracy	4,885	15
Total	32,665	100

Source: American Community Survey (ACS), Industry for the Civilian Employed Population 16 Years and Over, 2018; CHS Consulting Group, 2020

Additionally, all Project truck haul trips are expected to originate from the Port of Oakland. The resulting proportion of worker trips originating from each city and Project truck haul trips originating from the Port of Oakland were used to estimate a composite trip distribution for assigning Project trips to the study roadway network. Based on additional discussion with County Staff, it was determined there is potential for workers to originate locally from the Tri-Valley area, including Dublin, Livermore, Pleasanton, and San Ramon, and from Walnut Creek, Pittsburg, Byron, and Concord to the north. As a result, the majority of construction trips are expected use I-580, 10 percent would use Manning Road, and 10 percent would use North Livermore Avenue to access the Project site. **Table 7** shows the composite distribution of worker vehicle trips and truck haul trips on the study roadway network during the a.m. and p.m. peak hours.

Table 7: Peak Hour Project Vehicle Trip Distribution

Route	Proportion of Trips (%)
I-580 (to/from the east)	13
I-580 (to/from the west)	67
Manning Road (to/from the north)	10
North Livermore Avenue (to/from the south)	10

Project trips were then assigned to the study intersections based on the distribution of workers and truck trips during the a.m. and p.m. peak hours indicated in **Tables 6** and **7**. **Figure 6** presents the a.m. and p.m. peak hour trip distribution and trip assignment at Project study intersections. **Figure 7** presents the a.m. and p.m. peak hour Existing plus Project Conditions traffic volumes at the study intersections, resulting from the addition of Project trips to Existing Conditions traffic volumes.

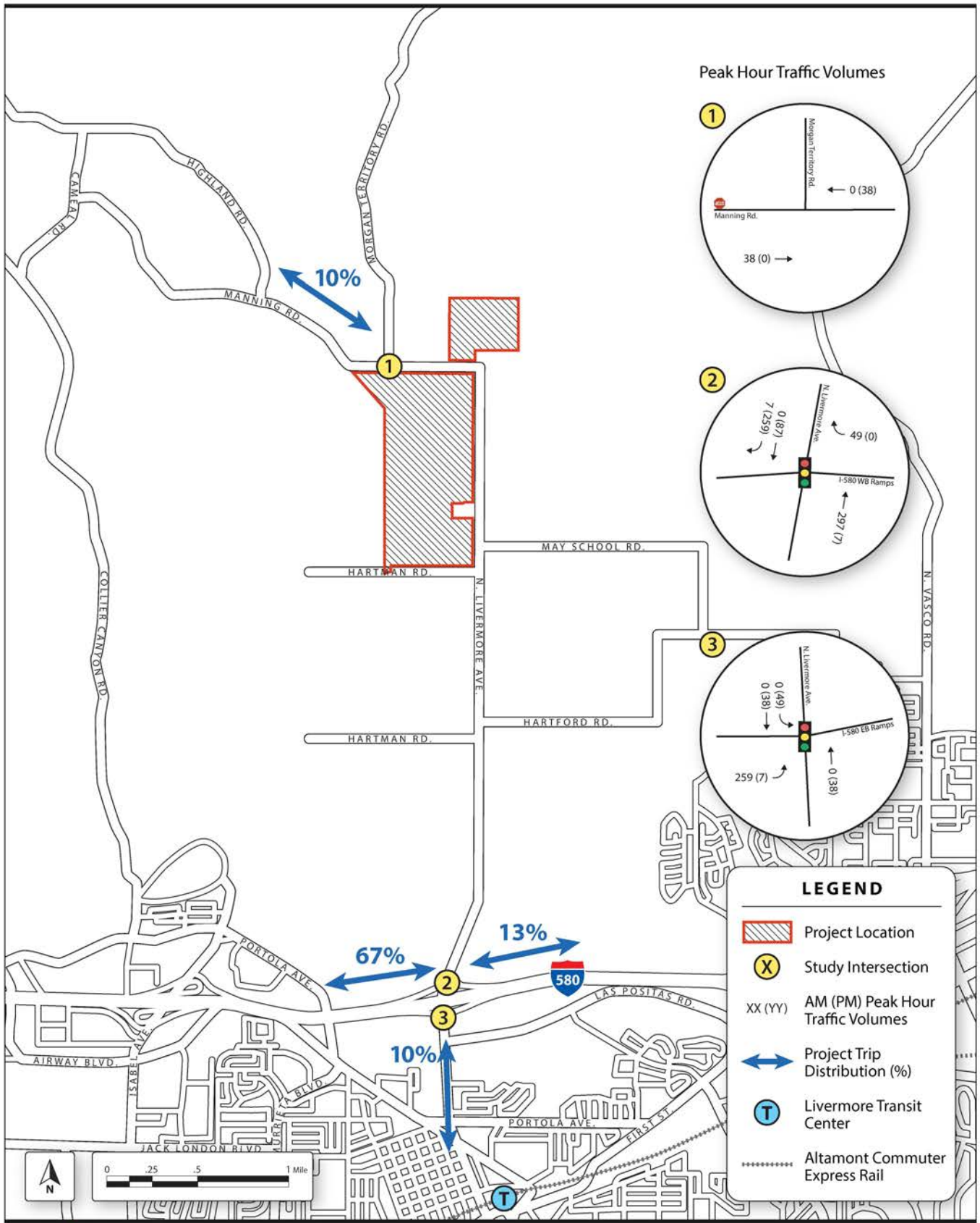

Aram Renewable Energy Project Transportation Impact Study

Figure 6
Project Trip Distribution and Trip Assignments

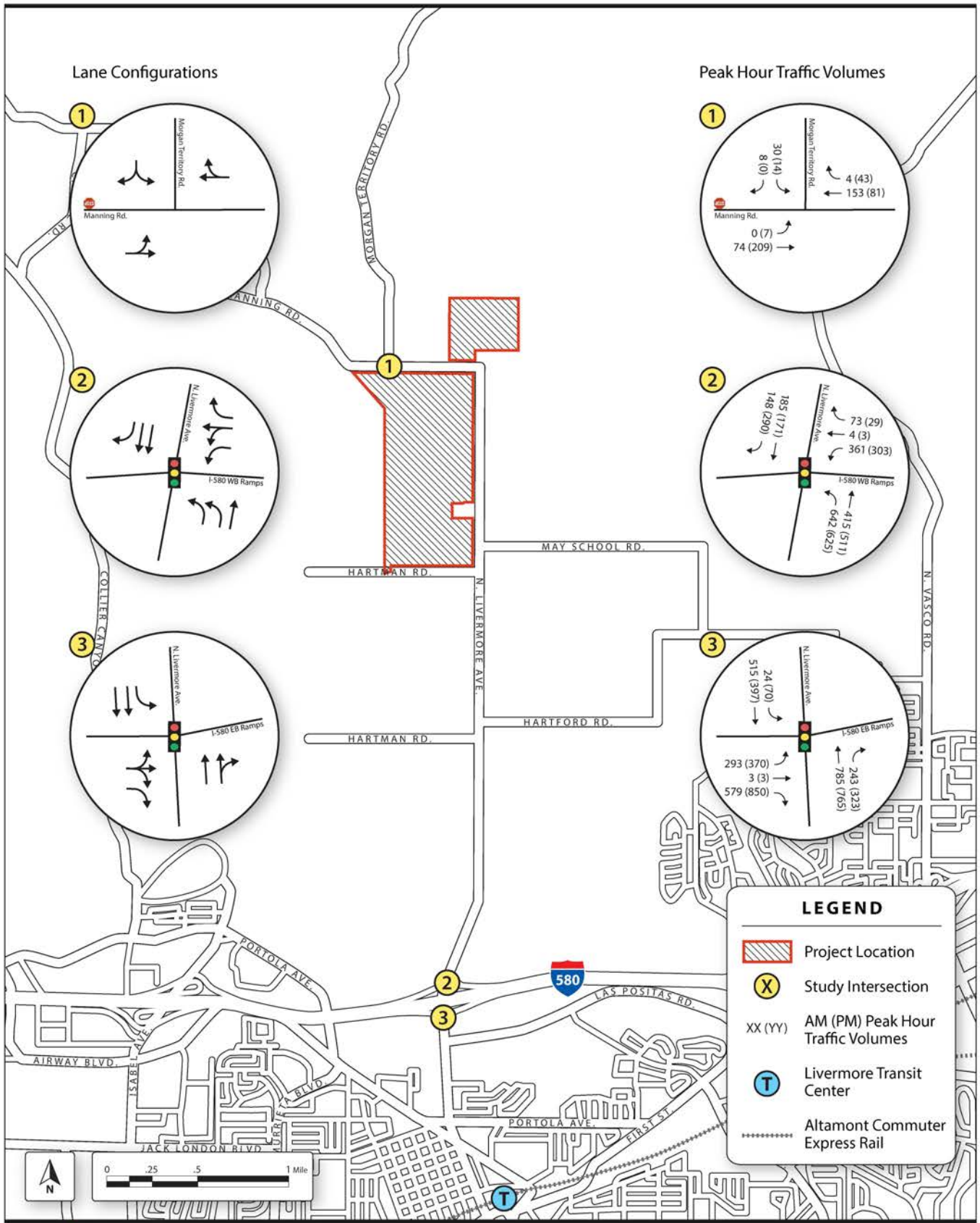

Aram Renewable Energy Project Transportation Impact Study

Figure 7
Existing plus Project Conditions Lane Configurations
and Peak Hour Traffic Volumes

4.3 Level of Service Analysis – Existing plus Project Conditions

Table 8 presents the LOS and delay analysis results for study intersections during the weekday a.m. and p.m. peak hours under Existing plus Project Conditions. Existing plus Project Conditions intersection LOS calculations are provided in **Appendix E**.

Table 8: Existing plus Project Conditions: Peak Hour Intersection LOS Results

Intersection	Control Type	Existing				Existing plus Project			
		AM Peak Hr.		PM Peak Hr.		AM Peak Hr.		PM Peak Hr.	
		Delay	LOS	Delay	LOS	Delay	LOS	Delay	LOS
1. Morgan Territory Rd. / Manning Rd.	OWSC	9.9	A	10.7	B	10.4	B	11.5	B
2. North Livermore Ave. / I-580 WB Ramps	Signalized	16.9	B	16.5	B	15.7	B	19.3	B
3. North Livermore Ave. / I-580 EB Ramps	Signalized	10.7	B	26.6	C	18.5	B	31.2	C

Source: CHS Consulting Group, 2018

Notes:

1. Delay reported as seconds per vehicle. For signalized intersections, a weighted average delay and level of service (LOS) based on all intersection approaches is reported.
2. LOS = Level of Service; OWSC = One-Way Stop Controlled; WB = westbound; EB = eastbound

As shown in **Table 8**, with the addition of Project construction traffic, all study intersections would continue to operate acceptably at LOS C or better with minimal added delays under Existing plus Project Conditions. Therefore, the Project is not expected to cause a significant impact with respect to traffic. It should be noted that this analysis assumes a worst-case-scenario in which all workers drive to/from the Project site alone, and thus the Project could generate less vehicle delay if workers were encouraged to carpool, subject to participation if construction were to occur during the Covid-19 pandemic.

4.4 95th Percentile Vehicle Queue Length Analysis – Existing plus Project Conditions

Peak hour 95th percentile queue lengths were additionally analyzed and compared with the existing storage capacity of study intersection turn lanes where Project-generated traffic is expected to be added to determine any capacity concerns. Existing and Existing plus Project peak hour intersection queue analysis results are compared in **Table 9**. Detailed 95th percentile queue length analysis calculations are provided in **Appendix E**.

As shown in **Table 9**, under Existing plus Project Conditions the 95th percentile queue lengths at study intersections would continue to be accommodated within available storage capacity without spillover during the peak of construction activity.

Table 9: Existing plus Project Conditions: Peak Hour Intersection Queue Analysis Results

Intersection	Turn Pocket	Storage Capacity (feet)	95th Percentile Queue Length (feet)			
			Existing		Existing plus Project	
			AM Peak Hour ¹	PM Peak Hour	AM Peak Hour ¹	PM Peak Hour
North Livermore Ave. / I-580 WB Ramps	SBR	140	40	0	40	58
North Livermore Ave. / I-580 EB Ramps	EBLTR	530	66	454	313	467
	SBL	240	16	8	16	76

Source: CHS Consulting Group, 2020

Notes:

1. Results for the a.m. peak hour queue analysis can be reasonably expected based on field observations of existing a.m. peak hour vehicle queues conducted on Thursday, February 26, 2020.
2. Bold text indicates 95th percentile queue length exceeds existing turn pocket capacity
3. WB = westbound; EB = eastbound; EBLTR = eastbound shared left, thru, right lane; SBL = southbound left-turn lane; SBR = southbound right-turn lane

4.5 Vehicle Miles Traveled – Existing plus Project Conditions

As discussed in Section 3.1, Alameda County is currently transitioning to VMT as the County’s CEQA threshold of significance related to transportation impacts, and thus the following VMT impact analysis relative to the Project is provided pursuant to CEQA Guidelines Appendix G. Detailed Project VMT calculations are provided in **Appendix F**.

4.5.1 Project VMT Analysis Methodology

Project-generated daily VMT were estimated separately for each Project trip type, based on Project-specific data for each of the four phases of construction. Project trip types are discussed individually below.

Daily Worker Commute Trips

As discussed in Section 4.1, Project-specific worker home-origin data provided by the Project Sponsor, assumed that the workforce would be based in the cities of Oakland, San Leandro, Hayward, Fremont, and Tracy.

For the purpose of assigning a distance for daily worker commute trips, a Google Maps measurement was utilized to approximate a centroid location for each of the worker origin cities. Based on Google Maps city centroid distance measurements to the Project site, the daily VMT analysis assumed a distance of 31.7 miles for worker commute trips to/from Oakland, 25.7 miles to/from San Leandro, 24.5 miles to/from Hayward, 37.5 miles to/from Hayward, and 21.9 miles to/from Tracy. This analysis represents a conservative worst-case scenario, as some workers may originate from the Tri-Valley area and other communities to the north that are closer in proximity to the Project site. The worker commute analysis assumed one daily round-trip per worker, with all workers arriving to the Project site during the a.m. peak hour and departing the Project site during the p.m. peak hour.

Daily Worker Off-Site Midday Trips

It is anticipated that each Project construction worker would take a midday off-site round trip for lunch or other work purposes. In order to conservatively estimate the daily VMT associated with these trips, it was assumed that each worker would take one round-trip to/from downtown Livermore, approximately 4.6 miles south of the Project site. For the peak overlap of Phases 2, 3, and 4, the number of worker off-site trips would be 750 (375 inbound and 375 outbound). These assumptions represent a conservative worst-case scenario, as some workers may find closer lunch options or bring their lunch and eat at the Project site.

Daily Truck Haul Trips

Per Project-specific truck haul trip data provided by the Project sponsor, during the peak overlap of Phases 2, 3, and 4, up to 121 daily truck haul trips would be generated. It is anticipated that all Project truck haul trips would travel to and from the Port of Oakland, approximately 34.1 miles west of the Project site.

4.5.2 Project-Generated VMT Analysis Results

In order to calculate the daily VMT for the peak of Project construction (the 50-day duration of overlap between Phases 2, 3, and 4), daily VMT was first estimated for each individual Project construction phase.

The daily VMT for worker commute trips for each phase were estimated by multiplying the number of daily trips by the assumed distance for worker commute trips from the cities described earlier. The VMT results for each city were then multiplied by each city's ACS construction workforce population percentage. The resulting daily VMT for each city were then combined for the total daily worker commute trip VMT per phase.

The daily VMT for worker off-site trips per phase were estimated by multiplying the number of daily trips by the assumed distance from the Project site to the commercial and dining locations in downtown Livermore (4.6 miles). Daily VMT for construction truck haul trips per phase were estimated by multiplying the total daily truck haul trips by the distance between the Project site and the Port of Oakland (34.1 miles). The total daily VMT for each trip type during Phases 2, 3, and 4 of Project construction were then combined to estimate the total daily VMT for a typical workday during the peak of Project construction. **Table 10** shows the resulting total daily VMT and daily per capita VMT generated by the Project during the peak of construction activities.

Table 10: Project-Generated VMT Analysis Results

Trip Type	Total Daily VMT (miles)	Daily per Capita VMT (miles)
Worker Commute Trips (Home/Site)	21,616	57.6
Worker Midday Trips (Site and back)	3,454	9.2
Truck Haul Trips	4,127	68.2

Source: CHS Consulting Group, 2020

On a typical workday, the Project would generate 29,197 VMT. The worker VMT (21,616 miles for commute trips and 3,454 miles for midday trips) was divided by the number of anticipated workers on site during the peak of Project construction (375 workers), resulting in a daily per capita VMT of 66.9 miles. The number of peak daily truck haul trips (121) was divided by two (one worker driving two one-way trips to and from the Port

of Oakland). The total daily truck haul VMT of 4,127 miles was then divided by 60.5 trips, resulting in a daily per capita VMT of 68.2 miles for truck haul trips. These VMT estimates also represent the net VMT increase at the site, given there is minimal VMT generated currently.

4.6 Impact Discussion (CEQA Appendix G Checklist)

This section presents the Project's potential transportation-related impacts based on State CEQA Guidelines Appendix G described here:

a. Conflicts with a plan, ordinance, or policy addressing the circulation system, including transit, roadway, bicycle, and pedestrian facilities.

As discussed in Section 4.3, all study intersections would continue to operate within acceptable County, Alameda CTC, and Caltrans LOS standards, under Existing plus Project Conditions. Most maintenance and construction activities associated with the Project would be contained within the Project site and are not expected to result in the long-term closures of travel lanes or roadway segments, permanently alter the public access roadways, create new public roadways that could substantially change the travel patterns of vehicles and bicycles on surrounding roadways, or conflict with the policies and plans regarding bicycle facilities.

There are no transit or pedestrian facilities adjacent to the Project site that would be impacted by Project-generated construction traffic. Although the Project would add vehicular traffic to intersections used by WHEELS bus route 580X, these study intersections would continue to operate at the same LOS as existing conditions and thus would not affect transit operations in the vicinity of the Project site.

There are Class II bike lanes along North Livermore Avenue adjacent to the Project site where there were no observed bicycle trips during the weekday a.m. and p.m. peak hours. However, the rural roadways in the study area are generally used for recreational and inter-regional travel that typically occur outside of the typical weekday peak commute periods and on weekends. During construction, slow-moving oversized trucks could potentially disrupt the movement of bicycles on North Livermore Avenue and Manning Road in the study area. However, Project construction activities would primarily occur between 7:00 a.m. and 7:00 p.m. on weekdays with the highest concentration of construction-generated traffic occurring during the typical a.m. and p.m. peak commute periods when bicycle volumes are low, and no weekend work is anticipated. No lane or road closures are anticipated during Project construction that could temporarily disrupt bicycle access on these roads. Furthermore, the analyzed Project-generated traffic would be related to temporary construction whose short-term traffic increases end when construction activities are completed.

For these reasons, the Project would not conflict with a plan, ordinance, or policy addressing the circulation system, including transit, roadway, bicycle, and pedestrian facilities. Therefore, the Project would result in less-than-significant impacts to the performance of the local circulation system.

b. Conflicts, or is inconsistent, with CEQA Guidelines section 15064.3, subdivision (b)(1).

The Project would represent an increase in VMT during the nine-month construction period compared with the existing agricultural cultivation and grazing uses at the Project. The Project at the construction peak would generate a daily per capita VMT of 66.9 miles for workers and 68.2 miles for truck haul trips. However, once the Project is constructed and in operation, an average of four workers would be onsite each weekday and up to 12 workers would access the site once annually for scheduled module washing. This would result in fewer than 110 trips per day to the Project site. As per Office of Planning and Research (OPR) guidance, projects that generate or attract fewer than 110 trips per day generally may be assumed to cause a less-than-significant transportation impact.¹² For these reasons, the Project would result in less-than-significant impacts related to VMT.

c. Substantially increases hazards due to a geometric design feature (e.g. sharp curves or dangerous intersections) or incompatible uses (e.g., farm equipment).

The Project would not permanently alter any roadways that would result in a design feature that could substantially increase hazards. The Project would construct new driveways at four access points along North Manning Road, two access points along North Livermore Avenue, and one access point along Hartman Road that would conform to County sight distance standards and would not introduce new hazards. All Project solar arrays and other structures would be set back from public roadways to avoid any sight distance hazards. The Project land use is considered a compatible use as discussed in the land use analysis of the Project. For these reasons, the Project would result in less-than-significant impacts related to increased hazards due to design features or incompatible uses.

d. Result in inadequate emergency access.

The Project would not permanently alter any roadways nor create any traffic conditions that would impede emergency access. Furthermore, the analyzed Project-generated traffic would be related to temporary construction whose short-term traffic increases would end when construction is completed. Therefore, the Project would result in less-than-significant impacts related to emergency access.

¹² Source: https://opr.ca.gov/docs/20190122-743_Technical_Advisory.pdf, accessed August 2020.

5.0 CONCLUSIONS

This section presents the conclusions for the Aramis Renewable Energy Project Transportation Impact Study in unincorporated Alameda County. Implementation of the Project would result in less than significant transportation impacts, and therefore, no mitigation measures are required.

- Under Existing Conditions, all three study intersections operate at LOS C or better.
- Under Existing Conditions, 95th percentile vehicle queue lengths at study intersections are accommodated by available storage capacity and no spillover conditions were observed.
- The peak of Project construction activities is expected to generate up to 1,621 daily trips, including 1,500 worker vehicle trips and 121 truck haul trips. This includes up to 389 a.m. and 389 p.m. peak hour trips, with 375 peak hour worker vehicle trips and 14 truck haul trips each peak hour.
- Under Existing plus Project Conditions, study intersections are anticipated to continue to operate at LOS C or better. As such, no significant impacts are expected with respect to Project traffic.
- Under Existing plus Project Conditions, the Project would increase 95th percentile queue lengths modestly at study intersection turn lanes during both the a.m. and p.m. peak hours. However, these queues would continue to be accommodated by available storage capacity during construction.
- The Project would not conflict with a plan, ordinance, or policy addressing the circulation system, including transit, roadway, bicycle, and pedestrian facilities; and thus, would result in less-than-significant impacts to the performance of the local circulation system.
- The Project at the construction peak would generate a daily per capita VMT of 66.9 miles for workers and 68.2 miles for truck haul trips. These results represent the net increase at the site, given there is minimal VMT generated currently. However, once in operation, the Project would generate fewer than 110 trips per day and per OPR guidance, would result in less-than-significant transportation impacts related to VMT.
- The Project would not substantially increase hazards due to a geometric design feature or incompatible uses and thus, the Project would result in less-than-significant transportation impacts.
- The Project would not permanently alter any roadways nor create any traffic conditions that would impede emergency access and thus, the Project would result in less-than-significant impacts related to emergency access.
- Although no traffic impacts have been identified, it is recommended that the contractor encourage carpooling/vanpooling during construction (subject to participation during the Covid-19 pandemic) to reduce the vehicular footprint at the site as well as the number of trips using I-580 and North Livermore Avenue. Such measures to reduce worker trips would reduce the estimated increase in vehicle delay and 95th percentile vehicle queue lengths during construction.

Appendices

- Appendix A Detailed Project Site Plans
- Appendix B AM and PM Peak Hour Intersection Turning Movement Counts
- Appendix C Existing Conditions LOS and Queue Length Calculations
- Appendix D Detailed Project Trip Generation Calculations
- Appendix E Existing plus Project Conditions LOS and Queue Length Calculations
- Appendix F Detailed Project-Generated Vehicle Miles Traveled (VMT) Calculations

APPENDIX A – DETAILED PROJECT SITE PLANS

Aramis Solar

Up to 102-MW-AC

Alameda County, CA

Conditional Use Permit Plan

PROJECT OWNER/DEVELOPER

CONTACT: MARISA MITCHELL
PHONE: (415) 846-0730

ENGINEERING PROJECT MANAGER

WESTWOOD PROFESSIONAL SERVICES, INC.
N., 2740 DALLAS PKWY. #280
PLANO, TX
CONTACT: JACK HAYS
PHONE: (972) 473-4640

PROJECT CIVIL ENGINEER OF RECORD

WESTWOOD PROFESSIONAL SERVICES, INC.
12701 WHITWATER DRIVE SUITE #300
MINNETONKA, MN 55343
CONTACT: CHRIS CARDA, P.E.
PHONE: (952) 906-7459

Westwood

Phone (952) 937-5150 12701 Whitewater Drive, Suite #300
Fax (952) 937-5822 Minnetonka, MN 55343
Toll Free (888) 937-5150 westwoodps.com
Westwood Development Consultants, LLC

Designed: PDC

Checked: MPG

Drawn: PDC

Record Drawing by/date:

Revisions:	DATE	DESCRIPTION
A	08/13/20	ADDED UTILITY CROSSING LOCATIONS
B	08/31/20	SUBSTATION RELOCATED

Prepared for:

IP Aramis, LLC

DIRECTIONS TO SITE

- HEADING EAST ON I-580
1. TAKE EXIT 52 FOR N. LIVERMORE AVE. TOWARD LIVERMORE.
2. TURN LEFT ONTO N. LIVERMORE AVE.
3. DRIVE APPROXIMATELY 2.9 MILES NORTH.
4. THE SITE ENTRANCE WILL BE ON THE LEFT.

Sheet List Table	
Sheet Number	Sheet Title
T.100	COVER
C.100	EXISTING CONDITIONS PLAN-NORTH
C.101	EXISTING CONDITIONS PLAN-SOUTH
C.200	CIVIL SITE PLAN-NORTH
C.201	CIVIL SITE PLAN-SOUTH
C.400	CONSTRUCTION DETAILS
C.401	CONSTRUCTION DETAILS

Regional Map

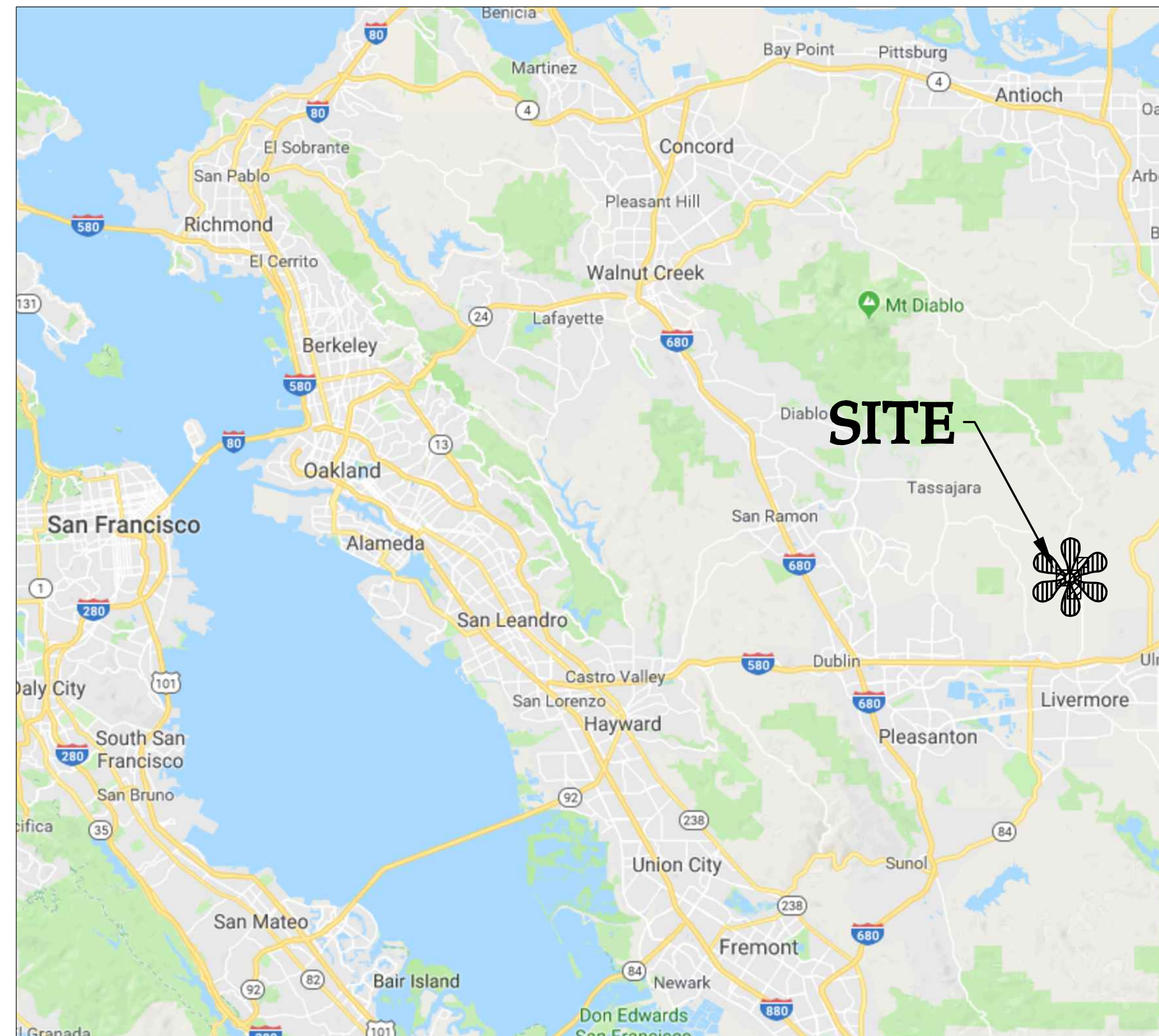

SOURCE: MAP DATA ©2018 GOOGLE (NOT TO SCALE)

Vicinity Map



SOURCE: MAP DATA ©2018 GOOGLE (NOT TO SCALE)

PROJECT LOCATION

LATITUDE= 37° 44' 57.29"
LONGITUDE= -121° 46' 25.79"

PROJECT COORDINATE SYSTEM

NSRS 2011 CALIFORNIA STATE PLANE, ZONE III, US FOOT

FEMA MAPPING

FIRM PANELS 06001C0332G AND 06013C0500F

APN
903-0007-002-01
903-0006-003-07
903-0006-001-02

IP Aramis, LLC

Alameda County, CA

Cover

**Issued For Review
Not For Construction**

Date: 08/31/2020

Drawing No: T.100

LEGEND:

- PROJECT BOUNDARY LINE
- - - EXISTING EASEMENT LINE
- - - EXISTING RIGHT-OF-WAY LINE
- POH EXISTING OVERHEAD POWERLINE
- ▬ EXISTING PAVED ROAD
- ▬ EXISTING GRAVEL ROAD
- 1070 EXISTING INDEX CONTOUR LINE
- 1071 EXISTING INTERVAL CONTOUR LINE
- - - EXISTING STREAM BANK
- - - SETBACK FROM STREAM BANK
- ▨ EXISTING FEMA REGULATORY FLOODWAY
- ▨ EXISTING FEMA FLOOD ZONE X
- ▨ EXISTING FEMA FLOOD ZONE A
- 🌳 EXISTING TREE

NOTES:

1. MATURE TREES (AS SHOWN) WILL REMAIN.

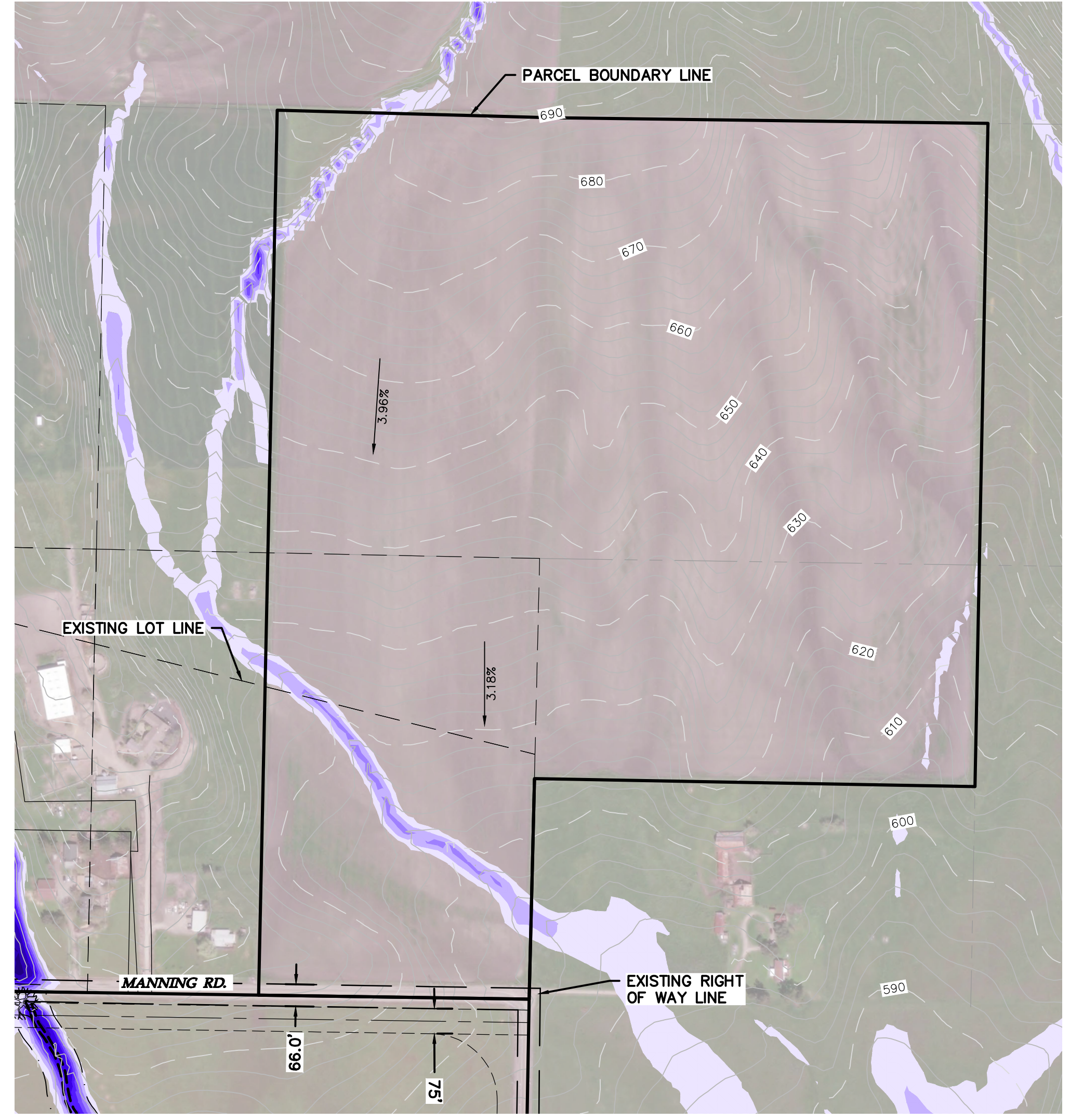

100 Year Max Flow Depth (ft)		
Minimum Elevation	Maximum Elevation	Color
0.50	1.00	Lightest Purple
1.01	1.50	Light Purple
1.51	2.00	Medium-Light Purple
2.01	2.50	Medium Purple
2.51	3.00	Dark Purple
3.01	4.00	Very Dark Purple
4.01	6.00	Black
6.00	20.00	Black

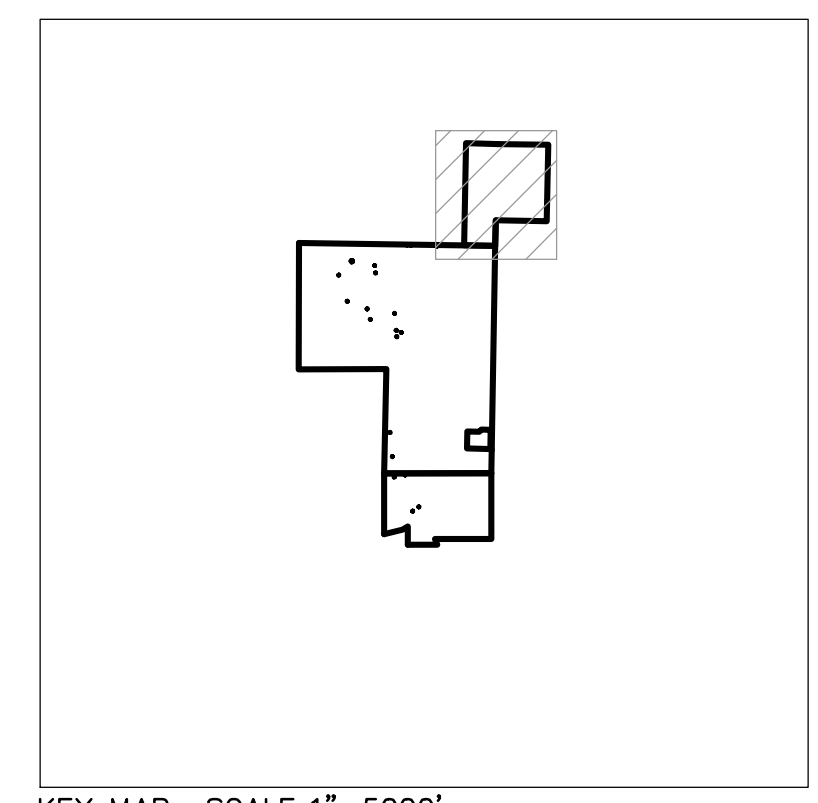
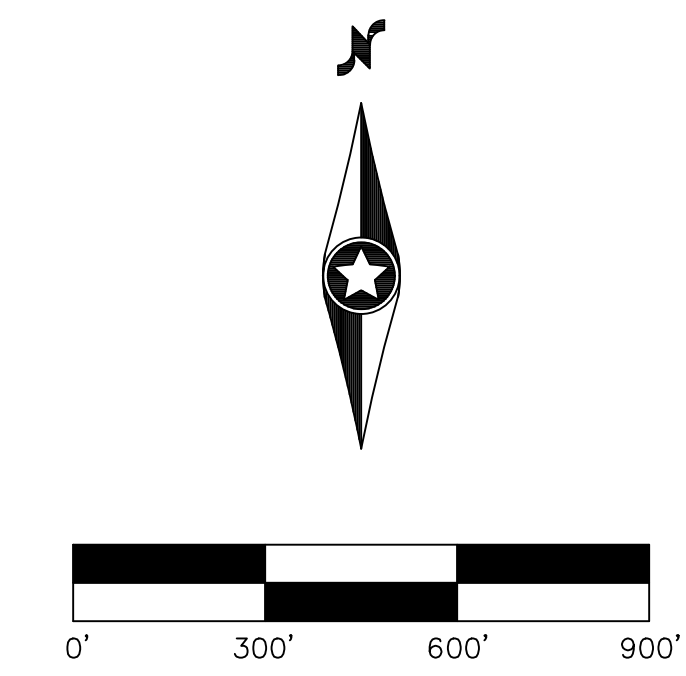

KEY MAP SCALE: 1"=5000'

Designed:	FDC
Checked:	MPG
Drawn:	FDC
Record Drawing by/date:	
Revisions:	
A 08/13/20	ADDED UTILITY CROSSING LOCATIONS
B 08/31/20	SUBSTATION RELOCATED

Prepared for:
IP Aramis, LLC

IP Aramis, LLC
Alameda County, CA

Existing Conditions
Plan-North

Issued For Review
Not For Construction

Date: 08/31/2020
Drawing No: C.100

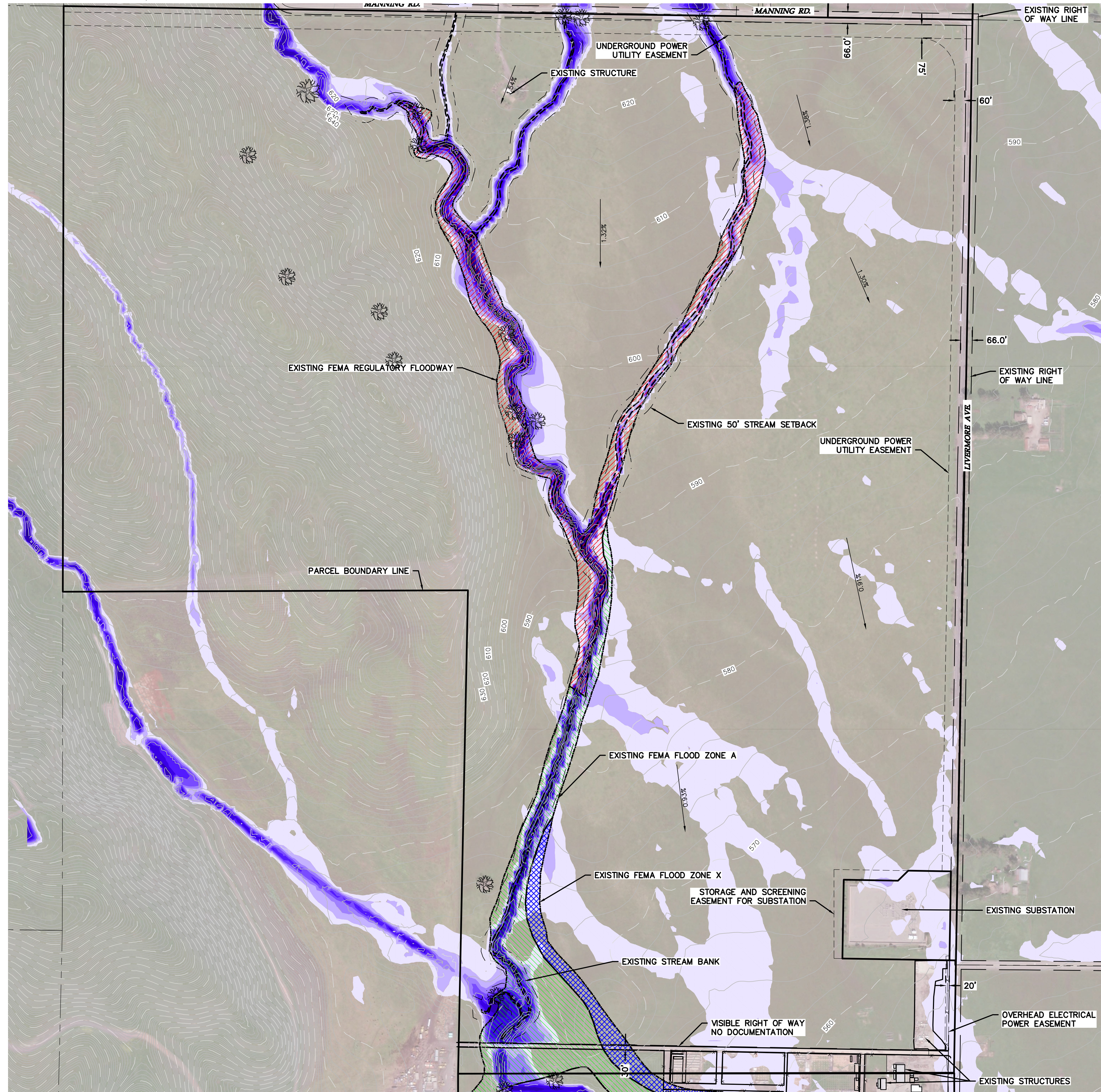

LEGEND:

- PROJECT BOUNDARY LINE
- EXISTING SECTION LINE
- EXISTING EASEMENT LINE
- EXISTING RIGHT-OF-WAY LINE
- EXISTING OVERHEAD POWERLINE
- EXISTING PAVED ROAD
- EXISTING GRAVEL ROAD
- EXISTING INDEX CONTOUR LINE
- EXISTING INTERVAL CONTOUR LINE
- EXISTING STREAM BANK
- SETBACK FROM STREAM BANK
- EXISTING FEMA REGULATORY FLOODWAY
- EXISTING FEMA FLOOD ZONE X
- EXISTING FEMA FLOOD ZONE A
- EXISTING TREE

NOTES:

1. MATURE TREES (AS SHOWN) WILL REMAIN.

100 Year Max Flow Depth (ft)		
Minimum Elevation	Maximum Elevation	Color
0.50	1.00	
1.01	1.50	
1.51	2.00	
2.01	2.50	
2.51	3.00	
3.01	4.00	
4.01	6.00	
6.00	20.00	

Designed:	FDC
Checked:	MPG
Drawn:	FDC
Record Drawing by/date:	
Revisions:	
A 08/13/20	ADDED UTILITY CROSSING LOCATIONS
B 08/31/20	SUBSTATION RELOCATED

Prepared for:
IP Aramis, LLC

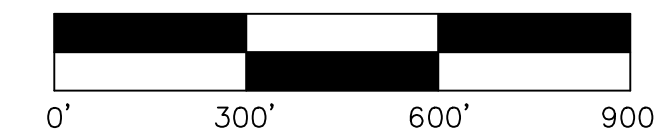
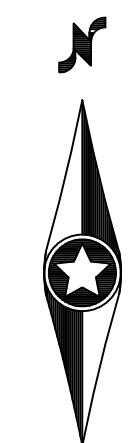

IP Aramis, LLC

Alameda County, CA

**Existing Conditions
Plan-South**

**Issued For Review
Not For Construction**

Date: 08/31/2020

Drawing No: C.101

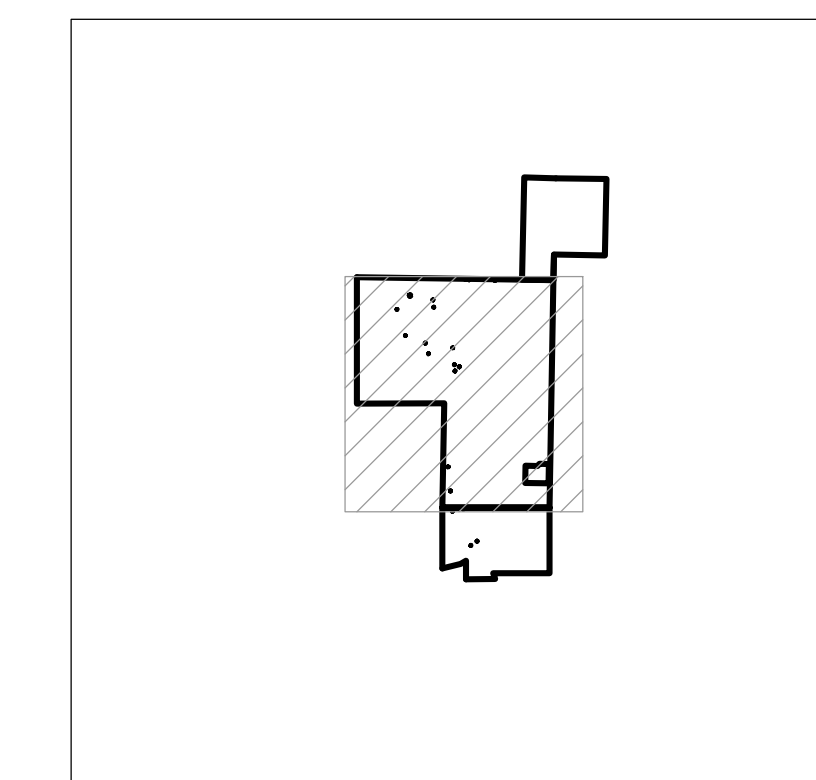

KEY MAP SCALE: 1"=5000'

LEGEND:

- PROJECT BOUNDARY LINE
- EXISTING SECTION LINE
- EXISTING EASEMENT LINE
- EXISTING RIGHT-OF-WAY LINE
- POH EXISTING OVERHEAD POWERLINE
- EXISTING PAVED ROAD
- EXISTING GRAVEL ROAD
- EXISTING INDEX CONTOUR LINE
- EXISTING INTERVAL CONTOUR LINE
- EXISTING STREAM BANK
- SETBACK FROM STREAM BANK
- [Red Hatched Box] EXISTING FEMA REGULATORY FLOODWAY
- [Blue Hatched Box] EXISTING FEMA FLOOD ZONE X
- [Green Hatched Box] EXISTING FEMA FLOOD ZONE A
- [Tree Symbol] EXISTING TREE

NOTES:

1. MATURE TREES (AS SHOWN) WILL REMAIN.

Designed:	FDC
Checked:	MPG
Drawn:	FDC
Record Drawing by/date:	
Revisions:	
A 08/13/20	ADDED UTILITY CROSSING LOCATIONS
B 08/31/20	SUBSTATION RELOCATED

Prepared for:

IP Aramis, LLC

100 Year Max Flow Depth (ft)		
Minimum Elevation	Maximum Elevation	Color
0.50	1.00	[Lightest Blue]
1.01	1.50	[Light Blue]
1.51	2.00	[Medium-Light Blue]
2.01	2.50	[Medium Blue]
2.51	3.00	[Dark Blue]
3.01	4.00	[Darkest Blue]
4.01	6.00	[Very Dark Blue]
6.00	20.00	[Black]

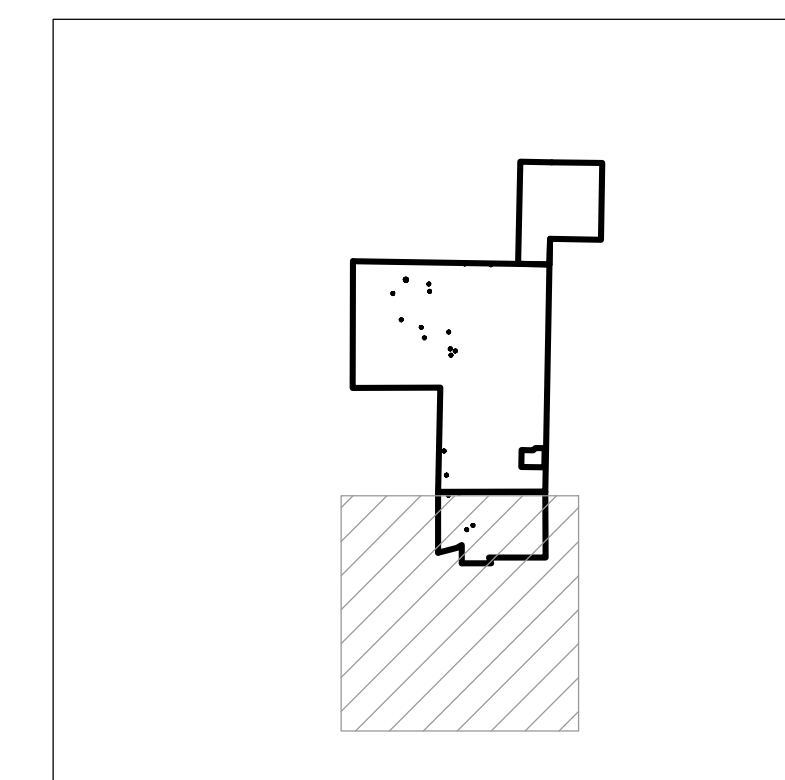
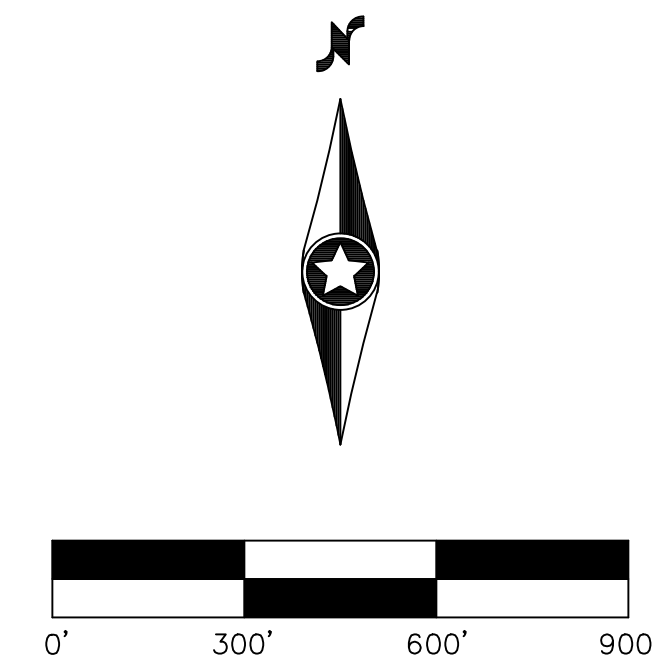

KEY MAP SCALE: 1"=5000'

IP Aramis, LLC

Alameda County, CA

























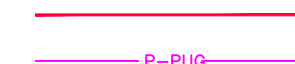
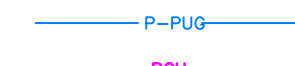

**Existing Conditions
Plan-South**

**Issued For Review
Not For Construction**

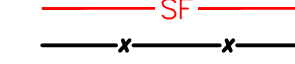
Date: 08/31/2020

Drawing No: C.102

LEGEND:

-  EXISTING PROPERTY LINE
-  EXISTING SECTION LINE
-  EXISTING EASEMENT LINE
-  EXISTING RIGHT-OF-WAY LINE
-  EXISTING OVERHEAD POWERLINE
-  EXISTING PAVED ROAD
-  EXISTING GRAVEL ROAD
-  EXISTING FEMA REGULATORY FLOODWAY
-  EXISTING FEMA FLOOD ZONE X
-  EXISTING FEMA FLOOD ZONE A
-  EXISTING STREAM BANK
-  EXISTING INDEX CONTOUR LINE
-  EXISTING INTERVAL CONTOUR LINE
-  PROPOSED SOLAR ARRAY
-  PROPOSED ELECTRICAL EQUIPMENT
-  PROPOSED ACCESS ROAD
-  PROPOSED WALKING PATH
-  UNDERGROUND MVAC ROUTE OPTION 1
-  UNDERGROUND MVAC ROUTE OPTION 2
-  OVERHEAD MVAC ROUTE
-  HDD (HORIZONTAL DIRECTIONAL DRILLING)
-  PROPOSED SILT FENCE
-  PROPOSED SECURITY FENCE
-  MODULE SETBACK LINE
-  DRAINAGE DIRECTION
-  PROPOSED SUBSTATION
-  PROPOSED LAYDOWN YARD
-  PROPOSED BATTERY ENERGY STORAGE SYSTEM

Designed: PDC

Checked: MPG

Drawn: PDC

Record Drawing by/date:







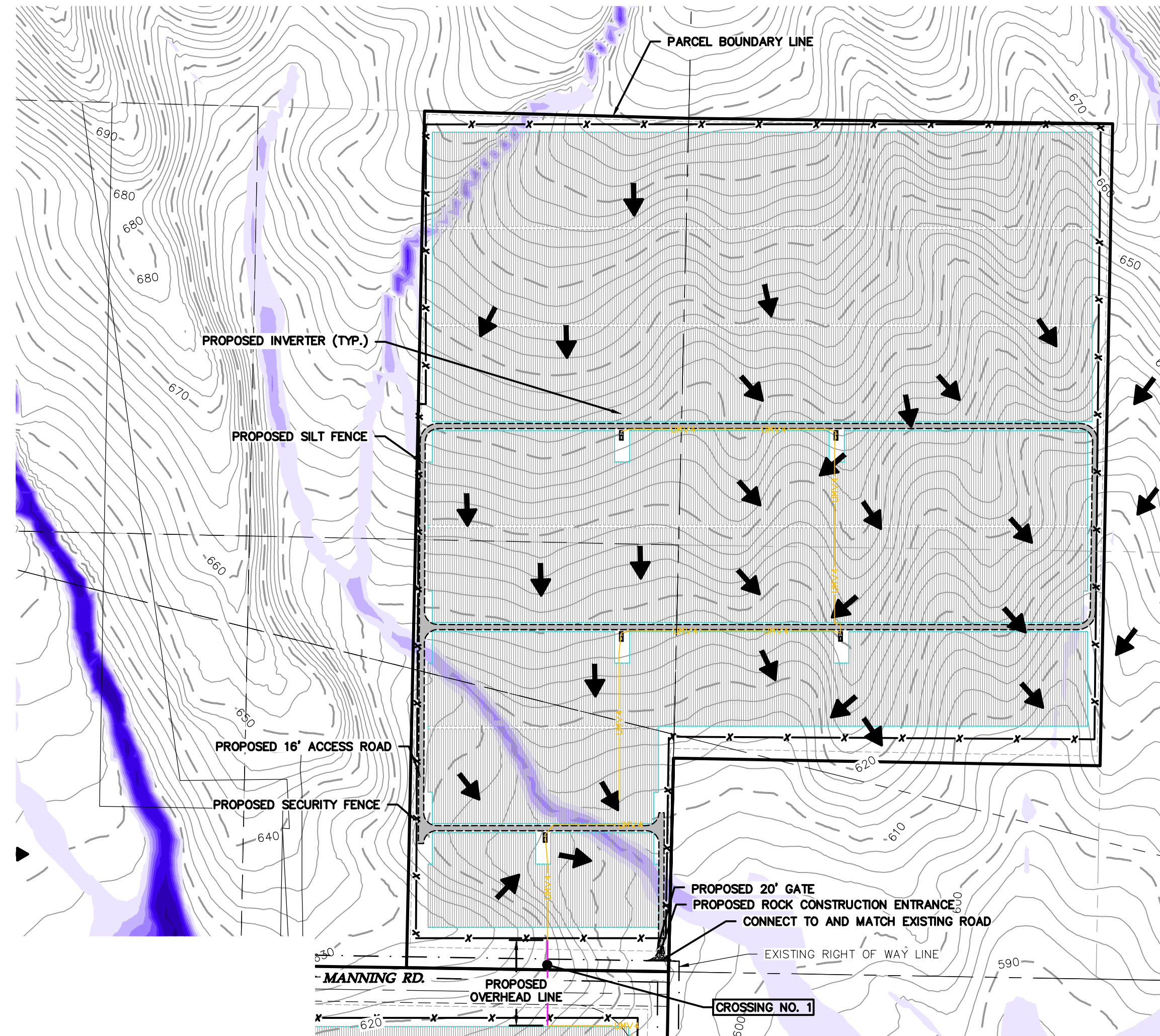

Revisions:
 A 08/13/20 ADDED UTILITY CROSSING LOCATIONS

B 08/31/20 SUBSTATION RELOCATED

Prepared for:

IP Aramis, LLC



100 Year Max Flow Depth (ft)		
Minimum Elevation	Maximum Elevation	Color
0.50	1.00	
1.01	1.50	
1.51	2.00	
2.01	2.50	
2.51	3.00	
3.01	4.00	
4.01	6.00	
6.00	20.00	

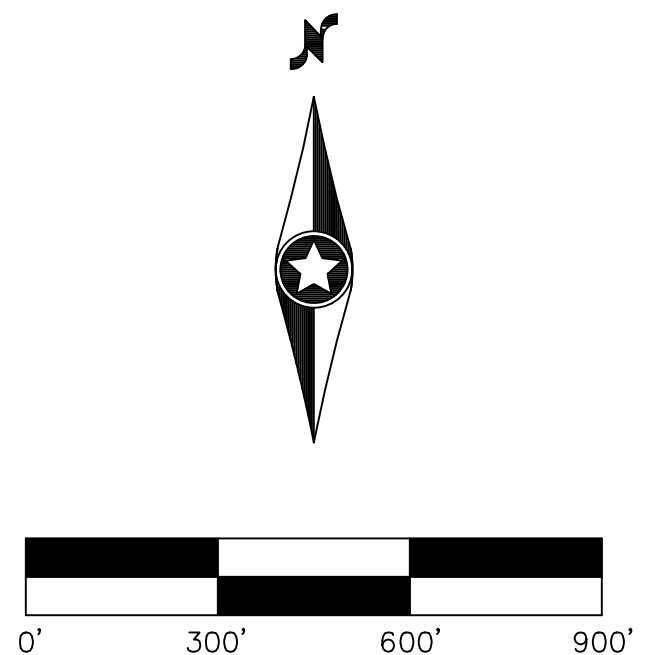

Project Module Setbacks

Item	Required
SIDE	10' FROM PROPERTY LINE
REAR	10' FROM PROPERTY LINE
FRONT	30' FROM PROPERTY LINE
STREAM BANK	50'

Disturbance Limits

Item	Area
TOTAL CLEARING AND GRUBBING (WITHIN PROPOSED SECURITY FENCE).	415 acres

Fenced Area

Location	Area (acres)
BOARDMAN (NORTH)	105
CROSBY (CENTRAL)	270
STANLEY (SOUTH)	40
TOTAL	415

IP Aramis, LLC

Alameda County, CA

Civil Site Plan-North

Issued For Review
 Not For Construction

Date: 08/31/2020

Drawing No: C.200_B

Location	Crossing Equipment	Existing Infrastructure	Infrastructure Owner/Responsible Party
1	overhead power line, 34.5kV	66' county road ROW (Manning) 75' power line easement	Alameda County Pacific Gas & Electric
2	underground power line, 2kV	waterway	Alameda County and/or local water district
3	overhead power line, 34.5kV	waterway	Alameda County and/or local water district
4	overhead power line, 34.5kV	FEMA Flood Zone "AE Floodway"	Alameda County and/or local water district
5	underground power line, 34.5kV	paved road (Hartman) FEMA Flood Zone X	Alameda County (no public ROW evident) Alameda County and/or local water district
6	overhead power line, 34.5kV	FEMA Flood Zone "AE Floodway" FEMA Flood Zone X	Alameda County and/or local water district Alameda County and/or local water district
7	underground power line, 34.5kV	FEMA Flood Zone AE 66' county road ROW (Livermore) 20' communications easement	Alameda County and/or local water district Alameda County Pacific Telephone & Telegraph (AT&T)

APPENDIX B – AM AND PM PEAK HOUR INTERSECTION TURNING MOVEMENT COUNTS

Morgan Territory Rd Manning Rd



Date: 02-26-2020
Count Period: 7:00 AM to 9:00 AM
Peak Hour: 7:45 AM to 8:45 AM

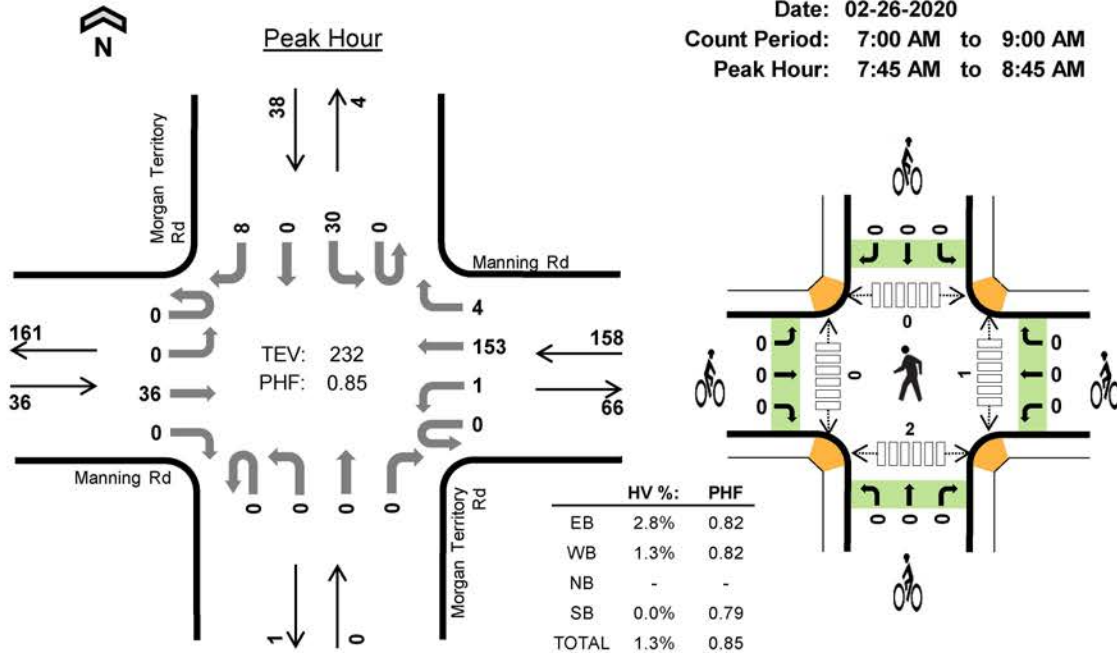

Two-Hour Count Summaries

Interval Start	Manning Rd Eastbound				Manning Rd Westbound				Morgan Territory Rd Northbound				Morgan Territory Rd Southbound				15-min Total	Rolling One Hour	
	UT	LT	TH	RT	UT	LT	TH	RT	UT	LT	TH	RT	UT	LT	TH	RT			
7:00 AM	0	0	5	0	0	0	25	1	0	0	0	1	0	4	0	0	36	0	
7:15 AM	0	0	11	0	0	0	34	0	0	0	0	0	0	7	0	1	53	0	
7:30 AM	0	0	11	0	0	0	33	1	0	0	0	0	0	6	0	2	53	0	
7:45 AM	0	0	8	0	0	1	39	1	0	0	0	0	0	4	0	2	55	197	
8:00 AM	0	0	9	0	0	0	31	0	0	0	0	0	0	8	0	2	50	211	
8:15 AM	0	0	11	0	0	0	37	1	0	0	0	0	0	8	0	2	59	217	
8:30 AM	0	0	8	0	0	0	46	2	0	0	0	0	0	10	0	2	68	232	
8:45 AM	0	0	6	0	0	0	31	2	0	0	0	0	0	4	0	1	44	221	
Count Total	0	0	69	0	0	1	276	8	0	0	0	1	0	51	0	12	418	0	
Peak Hour	All	0	0	36	0	0	1	153	4	0	0	0	0	0	30	0	8	232	0
	HV	0	0	1	0	0	0	2	0	0	0	0	0	0	0	0	0	3	0
	HV%	-	-	3%	-	-	0%	1%	0%	-	-	-	-	-	0%	-	0%	1%	0

Note: Two-hour count summary volumes include heavy vehicles but exclude bicycles in overall count.

Interval Start	Heavy Vehicle Totals					Bicycles					Pedestrians (Crossing Leg)				
	EB	WB	NB	SB	Total	EB	WB	NB	SB	Total	East	West	North	South	Total
7:00 AM	0	0	0	0	0	1	0	0	0	1	0	0	0	0	0
7:15 AM	0	0	0	1	1	0	0	0	0	0	0	0	0	0	0
7:30 AM	0	2	0	0	2	0	0	0	0	0	0	0	0	0	0
7:45 AM	0	0	0	0	0	0	0	0	0	0	1	0	0	2	3
8:00 AM	1	0	0	0	1	0	0	0	0	0	0	0	0	0	0
8:15 AM	0	1	0	0	1	0	0	0	0	0	0	0	0	0	0
8:30 AM	0	1	0	0	1	0	0	0	0	0	0	0	0	0	0
8:45 AM	1	0	0	0	1	0	0	0	0	0	0	0	0	0	0
Count Total	2	4	0	1	7	1	0	0	0	1	1	0	0	2	3
Peak Hour	1	2	0	0	3	0	0	0	0	0	1	0	0	2	3

Two-Hour Count Summaries - Heavy Vehicles																		
Interval Start	Manning Rd				Manning Rd				Morgan Territory Rd				Morgan Territory Rd				15-min Total	Rolling One Hour
	Eastbound				Westbound				Northbound				Southbound					
	UT	LT	TH	RT	UT	LT	TH	RT	UT	LT	TH	RT	UT	LT	TH	RT		
7:00 AM	0	0	0	0	0	0	0	0	0	0	0	0	0	0	0	0	0	
7:15 AM	0	0	0	0	0	0	0	0	0	0	0	0	0	1	0	0	1	
7:30 AM	0	0	0	0	0	0	2	0	0	0	0	0	0	0	0	0	2	
7:45 AM	0	0	0	0	0	0	0	0	0	0	0	0	0	0	0	0	0	
8:00 AM	0	0	1	0	0	0	0	0	0	0	0	0	0	0	0	0	1	
8:15 AM	0	0	0	0	0	0	1	0	0	0	0	0	0	0	0	0	1	
8:30 AM	0	0	0	0	0	0	1	0	0	0	0	0	0	0	0	0	1	
8:45 AM	0	0	1	0	0	0	0	0	0	0	0	0	0	0	0	0	1	
Count Total	0	0	2	0	0	0	4	0	0	0	0	0	1	0	0	7	0	
Peak Hour	0	0	1	0	0	0	2	0	0	0	0	0	0	0	0	3	0	
Two-Hour Count Summaries - Bikes																		
Interval Start	Manning Rd			Manning Rd			Morgan Territory Rd			Morgan Territory Rd			15-min Total	Rolling One Hour				
	Eastbound			Westbound			Northbound			Southbound								
	LT	TH	RT	LT	TH	RT	LT	TH	RT	LT	TH	RT						
7:00 AM	0	1	0	0	0	0	0	0	0	0	0	0	0	0	1	0		
7:15 AM	0	0	0	0	0	0	0	0	0	0	0	0	0	0	0	0		
7:30 AM	0	0	0	0	0	0	0	0	0	0	0	0	0	0	0	0		
7:45 AM	0	0	0	0	0	0	0	0	0	0	0	0	0	0	0	1		
8:00 AM	0	0	0	0	0	0	0	0	0	0	0	0	0	0	0	0		
8:15 AM	0	0	0	0	0	0	0	0	0	0	0	0	0	0	0	0		
8:30 AM	0	0	0	0	0	0	0	0	0	0	0	0	0	0	0	0		
8:45 AM	0	0	0	0	0	0	0	0	0	0	0	0	0	0	0	0		
Count Total	0	1	0	0	0	0	0	0	0	0	0	0	0	0	1	0		
Peak Hour	0	0	0	0	0	0	0	0	0	0	0	0	0	0	0	0		
<i>Note: U-Turn volumes for bikes are included in Left-Turn, if any.</i>																		

N Livermore Ave I-580 WB Ramps



Date: 02-26-2020
Count Period: 7:00 AM to 9:00 AM
Peak Hour: 7:30 AM to 8:30 AM

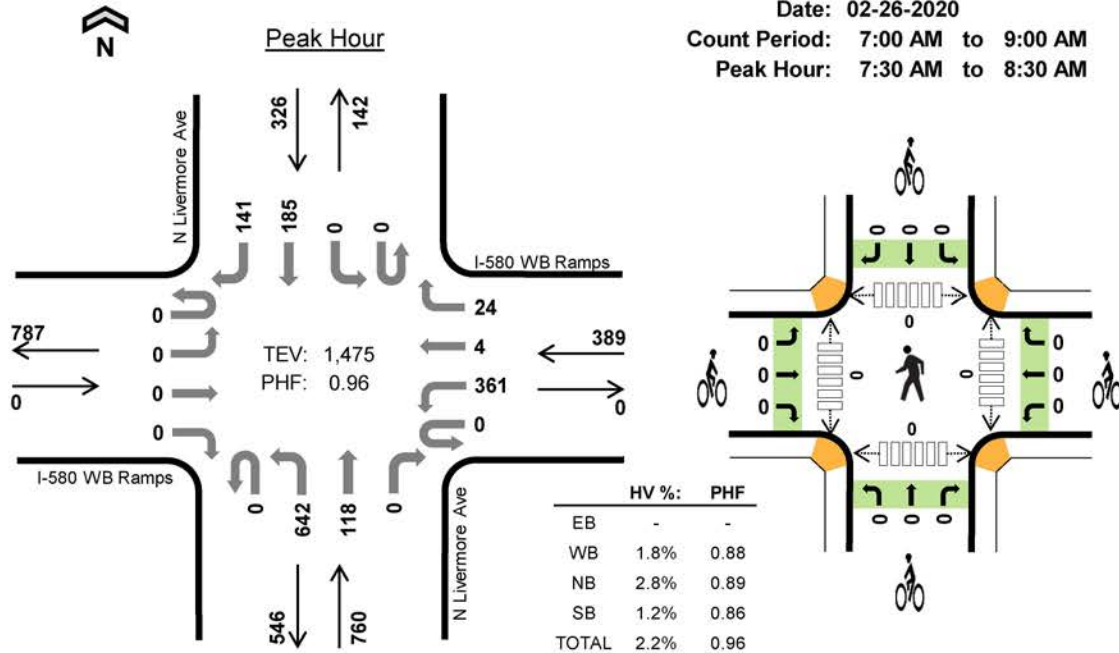

Two-Hour Count Summaries

Interval Start	I-580 WB Ramps Eastbound				I-580 WB Ramps Westbound				N Livermore Ave Northbound				N Livermore Ave Southbound				15-min Total	Rolling One Hour	
	UT	LT	TH	RT	UT	LT	TH	RT	UT	LT	TH	RT	UT	LT	TH	RT			
7:00 AM	0	0	0	0	0	63	0	8	0	155	10	0	0	0	15	27	278	0	
7:15 AM	0	0	0	0	0	83	0	5	0	153	12	0	0	0	43	28	324	0	
7:30 AM	0	0	0	0	0	95	0	2	0	172	26	0	0	0	45	40	380	0	
7:45 AM	0	0	0	0	0	100	2	8	0	142	24	0	0	0	38	28	342	1,324	
8:00 AM	0	0	0	0	0	81	1	7	0	174	40	0	0	0	45	35	383	1,429	
8:15 AM	0	0	0	0	0	85	1	7	0	154	28	0	0	0	57	38	370	1,475	
8:30 AM	0	0	0	0	0	80	0	11	0	126	25	0	0	0	35	42	319	1,414	
8:45 AM	0	0	0	0	0	86	5	6	0	143	17	0	0	0	31	46	334	1,406	
Count Total	0	0	0	0	0	673	9	54	0	1,219	182	0	0	0	309	284	2,730	0	
Peak Hour	All	0	0	0	0	0	361	4	24	0	642	118	0	0	0	185	141	1,475	0
	HV	0	0	0	0	0	6	0	1	0	15	6	0	0	0	3	1	32	0
	HV%	-	-	-	-	-	2%	0%	4%	-	2%	5%	-	-	-	2%	1%	2%	0

Note: Two-hour count summary volumes include heavy vehicles but exclude bicycles in overall count.

Interval Start	Heavy Vehicle Totals					Bicycles					Pedestrians (Crossing Leg)				
	EB	WB	NB	SB	Total	EB	WB	NB	SB	Total	East	West	North	South	Total
7:00 AM	0	2	6	0	8	0	0	0	0	0	0	0	0	0	0
7:15 AM	0	2	3	3	8	0	0	0	0	0	0	0	0	0	0
7:30 AM	0	2	9	0	11	0	0	0	0	0	0	0	0	0	0
7:45 AM	0	1	2	2	5	0	0	0	0	0	0	0	0	0	0
8:00 AM	0	2	7	1	10	0	0	0	0	0	0	0	0	0	0
8:15 AM	0	2	3	1	6	0	0	0	0	0	0	0	0	0	0
8:30 AM	0	2	3	1	6	0	0	0	0	0	0	0	0	0	0
8:45 AM	0	0	6	1	7	0	0	0	0	0	0	0	0	0	0
Count Total	0	13	39	9	61	0	0	0	0	0	0	0	0	0	0
Peak Hour	0	7	21	4	32	0	0	0	0	0	0	0	0	0	0

Two-Hour Count Summaries - Heavy Vehicles																		
Interval Start	I-580 WB Ramps				I-580 WB Ramps				N Livermore Ave				N Livermore Ave				15-min Total	Rolling One Hour
	Eastbound				Westbound				Northbound				Southbound					
	UT	LT	TH	RT	UT	LT	TH	RT	UT	LT	TH	RT	UT	LT	TH	RT		
7:00 AM	0	0	0	0	0	2	0	0	0	6	0	0	0	0	0	0	8	0
7:15 AM	0	0	0	0	0	2	0	0	0	3	0	0	0	0	0	3	8	0
7:30 AM	0	0	0	0	0	2	0	0	0	4	5	0	0	0	0	0	11	0
7:45 AM	0	0	0	0	0	1	0	0	0	2	0	0	0	0	0	1	5	32
8:00 AM	0	0	0	0	0	1	0	1	0	7	0	0	0	0	0	1	10	34
8:15 AM	0	0	0	0	0	2	0	0	0	2	1	0	0	0	0	1	6	32
8:30 AM	0	0	0	0	0	2	0	0	0	2	1	0	0	0	0	1	6	27
8:45 AM	0	0	0	0	0	0	0	0	0	6	0	0	0	0	0	1	7	29
Count Total	0	0	0	0	0	12	0	1	0	32	7	0	0	0	6	3	61	0
Peak Hour	0	0	0	0	0	6	0	1	0	15	6	0	0	0	3	1	32	0
Two-Hour Count Summaries - Bikes																		
Interval Start	I-580 WB Ramps			I-580 WB Ramps			N Livermore Ave			N Livermore Ave			15-min Total	Rolling One Hour				
	Eastbound			Westbound			Northbound			Southbound								
	LT	TH	RT	LT	TH	RT	LT	TH	RT	LT	TH	RT						
7:00 AM	0	0	0	0	0	0	0	0	0	0	0	0	0	0	0	0	0	0
7:15 AM	0	0	0	0	0	0	0	0	0	0	0	0	0	0	0	0	0	0
7:30 AM	0	0	0	0	0	0	0	0	0	0	0	0	0	0	0	0	0	0
7:45 AM	0	0	0	0	0	0	0	0	0	0	0	0	0	0	0	0	0	0
8:00 AM	0	0	0	0	0	0	0	0	0	0	0	0	0	0	0	0	0	0
8:15 AM	0	0	0	0	0	0	0	0	0	0	0	0	0	0	0	0	0	0
8:30 AM	0	0	0	0	0	0	0	0	0	0	0	0	0	0	0	0	0	0
8:45 AM	0	0	0	0	0	0	0	0	0	0	0	0	0	0	0	0	0	0
Count Total	0	0	0	0	0	0	0	0	0	0	0	0	0	0	0	0	0	0
Peak Hour	0	0	0	0	0	0	0	0	0	0	0	0	0	0	0	0	0	0
<i>Note: U-Turn volumes for bikes are included in Left-Turn, if any.</i>																		

N Livermore Ave I-580 EB Ramps



Date: 02-26-2020
Count Period: 7:00 AM to 9:00 AM
Peak Hour: 7:30 AM to 8:30 AM

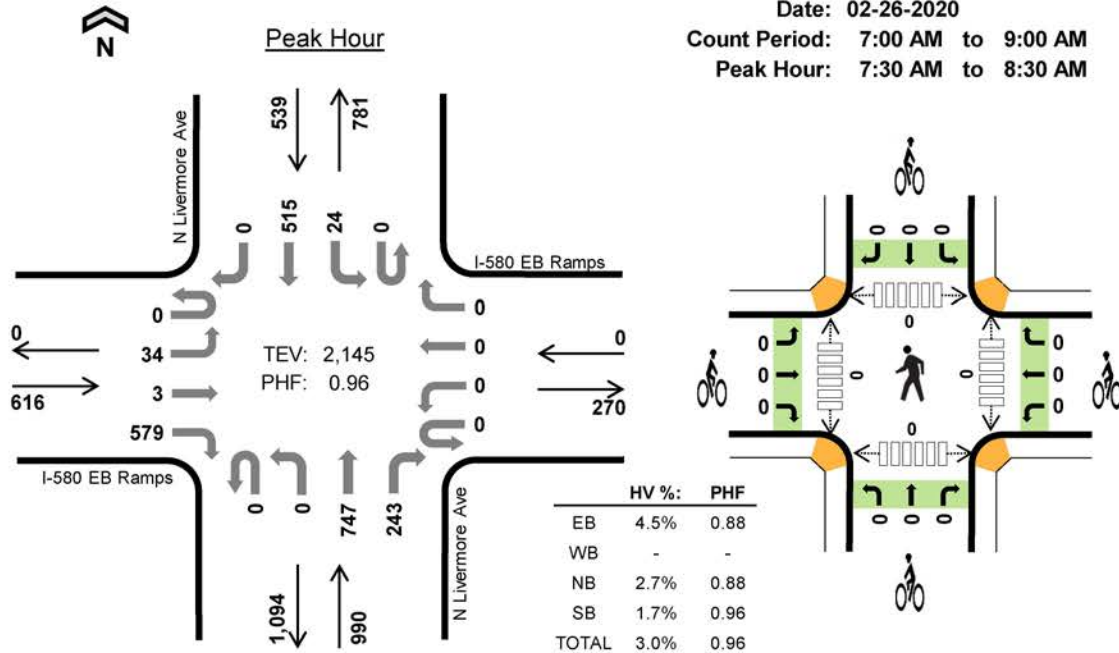

Two-Hour Count Summaries

Interval Start	I-580 EB Ramps Eastbound				I-580 EB Ramps Westbound				N Livermore Ave Northbound				N Livermore Ave Southbound				15-min Total	Rolling One Hour	
	UT	LT	TH	RT	UT	LT	TH	RT	UT	LT	TH	RT	UT	LT	TH	RT			
7:00 AM	0	5	0	79	0	0	0	0	0	0	163	48	0	5	74	0	374	0	
7:15 AM	0	2	1	122	0	0	0	0	0	0	167	60	0	9	118	0	479	0	
7:30 AM	0	10	0	124	0	0	0	0	0	0	189	46	0	7	134	0	510	0	
7:45 AM	0	7	1	168	0	0	0	0	0	0	154	60	0	4	130	0	524	1,887	
8:00 AM	0	11	1	130	0	0	0	0	0	0	216	65	0	6	121	0	550	2,063	
8:15 AM	0	6	1	157	0	0	0	0	0	0	188	72	0	7	130	0	561	2,145	
8:30 AM	0	6	0	139	0	0	0	0	0	0	130	58	0	5	109	0	447	2,082	
8:45 AM	0	6	0	163	0	0	0	0	0	0	150	39	0	6	106	0	470	2,028	
Count Total	0	53	4	1,082	0	0	0	0	0	0	1,357	448	0	49	922	0	3,915	0	
Peak Hour	All	0	34	3	579	0	0	0	0	0	0	747	243	0	24	515	0	2,145	0
	HV	0	7	2	19	0	0	0	0	0	0	15	12	0	2	7	0	64	0
	HV%	-	21%	67%	3%	-	-	-	-	-	-	2%	5%	-	8%	1%	-	3%	0

Note: Two-hour count summary volumes include heavy vehicles but exclude bicycles in overall count.

Interval Start	Heavy Vehicle Totals					Bicycles					Pedestrians (Crossing Leg)				
	EB	WB	NB	SB	Total	EB	WB	NB	SB	Total	East	West	North	South	Total
7:00 AM	4	0	6	2	12	0	0	0	0	0	0	0	0	0	0
7:15 AM	7	0	5	5	17	0	0	0	0	0	0	0	0	0	0
7:30 AM	12	0	7	2	21	0	0	0	0	0	0	0	0	0	0
7:45 AM	6	0	5	2	13	0	0	0	0	0	0	0	0	0	0
8:00 AM	7	0	10	2	19	0	0	0	0	0	0	0	0	0	0
8:15 AM	3	0	5	3	11	0	0	0	0	0	0	0	0	0	0
8:30 AM	2	0	8	2	12	0	0	0	0	0	0	0	0	0	0
8:45 AM	4	0	4	0	8	0	0	0	0	0	0	0	0	0	0
Count Total	45	0	50	18	113	0	0	0	0	0	0	0	0	0	0
Peak Hour	28	0	27	9	64	0	0	0	0	0	0	0	0	0	0

Two-Hour Count Summaries - Heavy Vehicles																		
Interval Start	I-580 EB Ramps				I-580 EB Ramps				N Livermore Ave				N Livermore Ave				15-min Total	Rolling One Hour
	Eastbound				Westbound				Northbound				Southbound					
	UT	LT	TH	RT	UT	LT	TH	RT	UT	LT	TH	RT	UT	LT	TH	RT		
7:00 AM	0	0	0	4	0	0	0	0	0	0	6	0	0	0	2	0	12	0
7:15 AM	0	0	0	7	0	0	0	0	0	0	3	2	0	3	2	0	17	0
7:30 AM	0	5	0	7	0	0	0	0	0	0	4	3	0	0	2	0	21	0
7:45 AM	0	0	1	5	0	0	0	0	0	0	4	1	0	0	2	0	13	63
8:00 AM	0	1	1	5	0	0	0	0	0	0	5	5	0	1	1	0	19	70
8:15 AM	0	1	0	2	0	0	0	0	0	0	2	3	0	1	2	0	11	64
8:30 AM	0	0	0	2	0	0	0	0	0	0	4	4	0	0	2	0	12	55
8:45 AM	0	0	0	4	0	0	0	0	0	0	4	0	0	0	0	0	8	50
Count Total	0	7	2	36	0	0	0	0	0	0	32	18	0	5	13	0	113	0
Peak Hour	0	7	2	19	0	0	0	0	0	0	15	12	0	2	7	0	64	0
Two-Hour Count Summaries - Bikes																		
Interval Start	I-580 EB Ramps			I-580 EB Ramps			N Livermore Ave			N Livermore Ave			15-min Total	Rolling One Hour				
	Eastbound			Westbound			Northbound			Southbound								
	LT	TH	RT	LT	TH	RT	LT	TH	RT	LT	TH	RT						
7:00 AM	0	0	0	0	0	0	0	0	0	0	0	0	0	0	0	0	0	0
7:15 AM	0	0	0	0	0	0	0	0	0	0	0	0	0	0	0	0	0	0
7:30 AM	0	0	0	0	0	0	0	0	0	0	0	0	0	0	0	0	0	0
7:45 AM	0	0	0	0	0	0	0	0	0	0	0	0	0	0	0	0	0	0
8:00 AM	0	0	0	0	0	0	0	0	0	0	0	0	0	0	0	0	0	0
8:15 AM	0	0	0	0	0	0	0	0	0	0	0	0	0	0	0	0	0	0
8:30 AM	0	0	0	0	0	0	0	0	0	0	0	0	0	0	0	0	0	0
8:45 AM	0	0	0	0	0	0	0	0	0	0	0	0	0	0	0	0	0	0
Count Total	0	0	0	0	0	0	0	0	0	0	0	0	0	0	0	0	0	0
Peak Hour	0	0	0	0	0	0	0	0	0	0	0	0	0	0	0	0	0	0
<i>Note: U-Turn volumes for bikes are included in Left-Turn, if any.</i>																		

Morgan Territory Rd Manning Rd



Date: 02-26-2020

Count Period: 4:00 PM to 6:00 PM

Peak Hour: 4:30 PM to 5:30 PM

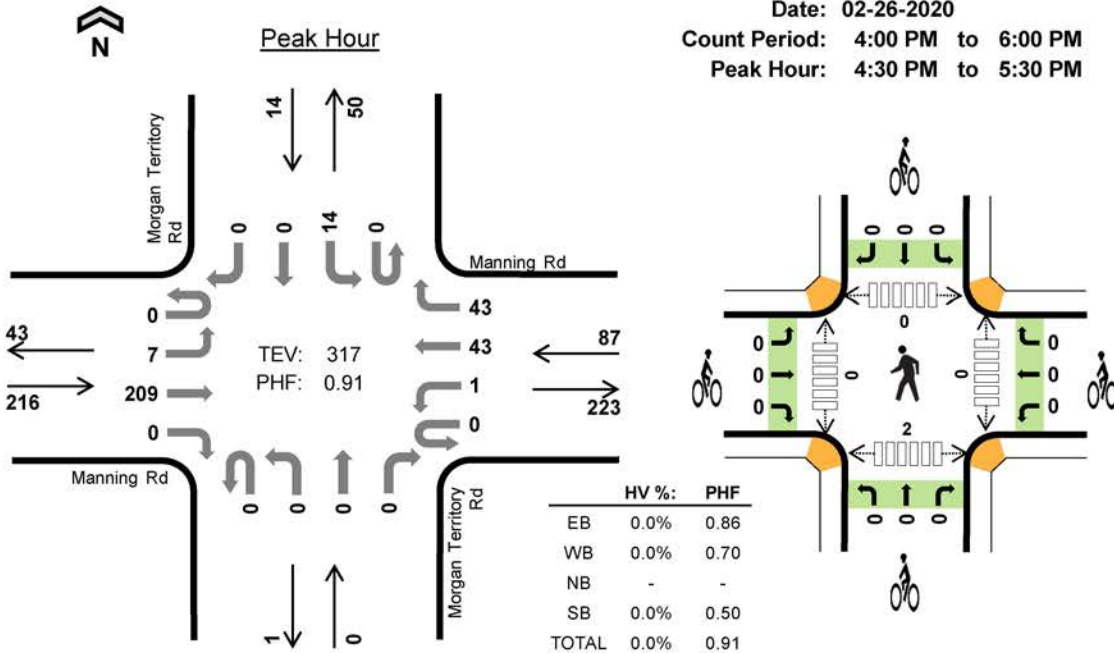

Two-Hour Count Summaries

Interval Start	Manning Rd Eastbound				Manning Rd Westbound				Morgan Territory Rd Northbound				Morgan Territory Rd Southbound				15-min Total	Rolling One Hour	
	UT	LT	TH	RT	UT	LT	TH	RT	UT	LT	TH	RT	UT	LT	TH	RT			
4:00 PM	0	1	65	0	0	0	8	5	0	0	0	0	0	4	0	1	84	0	
4:15 PM	0	1	30	0	0	0	7	8	0	0	0	0	0	2	0	0	48	0	
4:30 PM	0	1	51	0	0	0	11	10	0	0	0	0	0	2	0	0	75	0	
4:45 PM	0	3	60	0	0	1	9	7	0	0	0	0	0	7	0	0	87	294	
5:00 PM	0	1	47	0	0	0	8	10	0	0	0	0	0	3	0	0	69	279	
5:15 PM	0	2	51	0	0	0	15	16	0	0	0	0	0	2	0	0	86	317	
5:30 PM	0	4	39	0	0	0	11	6	0	0	0	0	0	4	0	1	65	307	
5:45 PM	0	2	45	0	0	0	7	10	0	0	0	0	0	1	0	0	65	285	
Count Total	0	15	388	0	0	1	76	72	0	0	0	0	0	25	0	2	579	0	
Peak Hour	All	0	7	209	0	0	1	43	43	0	0	0	0	0	14	0	0	317	0
	HV	0	0	0	0	0	0	0	0	0	0	0	0	0	0	0	0	0	0
	HV%	-	0%	0%	-	-	0%	0%	0%	-	-	-	-	-	0%	-	-	0%	0

Note: Two-hour count summary volumes include heavy vehicles but exclude bicycles in overall count.

Interval Start	Heavy Vehicle Totals					Bicycles					Pedestrians (Crossing Leg)				
	EB	WB	NB	SB	Total	EB	WB	NB	SB	Total	East	West	North	South	Total
4:00 PM	0	0	0	0	0	0	0	0	0	0	0	0	0	0	0
4:15 PM	0	0	0	0	0	0	0	0	0	0	0	0	0	0	0
4:30 PM	0	0	0	0	0	0	0	0	0	0	0	0	0	0	0
4:45 PM	0	0	0	0	0	0	0	0	0	0	0	0	0	2	2
5:00 PM	0	0	0	0	0	0	0	0	0	0	0	0	0	0	0
5:15 PM	0	0	0	0	0	0	0	0	0	0	0	0	0	0	0
5:30 PM	1	0	0	0	1	0	0	0	0	0	0	0	0	0	0
5:45 PM	0	0	0	0	0	0	0	0	0	0	0	0	0	0	0
Count Total	1	0	0	0	1	0	0	0	0	0	0	0	0	2	2
Peak Hour	0	0	0	0	0	0	0	0	0	0	0	0	0	2	2

Two-Hour Count Summaries - Heavy Vehicles																		
Interval Start	Manning Rd				Manning Rd				Morgan Territory Rd				Morgan Territory Rd				15-min Total	Rolling One Hour
	Eastbound				Westbound				Northbound				Southbound					
	UT	LT	TH	RT	UT	LT	TH	RT	UT	LT	TH	RT	UT	LT	TH	RT		
4:00 PM	0	0	0	0	0	0	0	0	0	0	0	0	0	0	0	0	0	
4:15 PM	0	0	0	0	0	0	0	0	0	0	0	0	0	0	0	0	0	
4:30 PM	0	0	0	0	0	0	0	0	0	0	0	0	0	0	0	0	0	
4:45 PM	0	0	0	0	0	0	0	0	0	0	0	0	0	0	0	0	0	
5:00 PM	0	0	0	0	0	0	0	0	0	0	0	0	0	0	0	0	0	
5:15 PM	0	0	0	0	0	0	0	0	0	0	0	0	0	0	0	0	0	
5:30 PM	0	0	1	0	0	0	0	0	0	0	0	0	0	0	0	1	1	
5:45 PM	0	0	0	0	0	0	0	0	0	0	0	0	0	0	0	0	1	
Count Total	0	0	1	0	0	0	0	0	0	0	0	0	0	0	0	1	0	
Peak Hour	0	0	0	0	0	0	0	0	0	0	0	0	0	0	0	0	0	
Two-Hour Count Summaries - Bikes																		
Interval Start	Manning Rd			Manning Rd			Morgan Territory Rd			Morgan Territory Rd			15-min Total	Rolling One Hour				
	Eastbound			Westbound			Northbound			Southbound								
	LT	TH	RT	LT	TH	RT	LT	TH	RT	LT	TH	RT						
4:00 PM	0	0	0	0	0	0	0	0	0	0	0	0	0	0	0	0		
4:15 PM	0	0	0	0	0	0	0	0	0	0	0	0	0	0	0	0		
4:30 PM	0	0	0	0	0	0	0	0	0	0	0	0	0	0	0	0		
4:45 PM	0	0	0	0	0	0	0	0	0	0	0	0	0	0	0	0		
5:00 PM	0	0	0	0	0	0	0	0	0	0	0	0	0	0	0	0		
5:15 PM	0	0	0	0	0	0	0	0	0	0	0	0	0	0	0	0		
5:30 PM	0	0	0	0	0	0	0	0	0	0	0	0	0	0	0	0		
5:45 PM	0	0	0	0	0	0	0	0	0	0	0	0	0	0	0	0		
Count Total	0	0	0	0	0	0	0	0	0	0	0	0	0	0	0	0		
Peak Hour	0	0	0	0	0	0	0	0	0	0	0	0	0	0	0	0		
<i>Note: U-Turn volumes for bikes are included in Left-Turn, if any.</i>																		

N Livermore Ave I-580 WB Ramps



Date: 02-26-2020
Count Period: 4:00 PM to 6:00 PM
Peak Hour: 4:30 PM to 5:30 PM

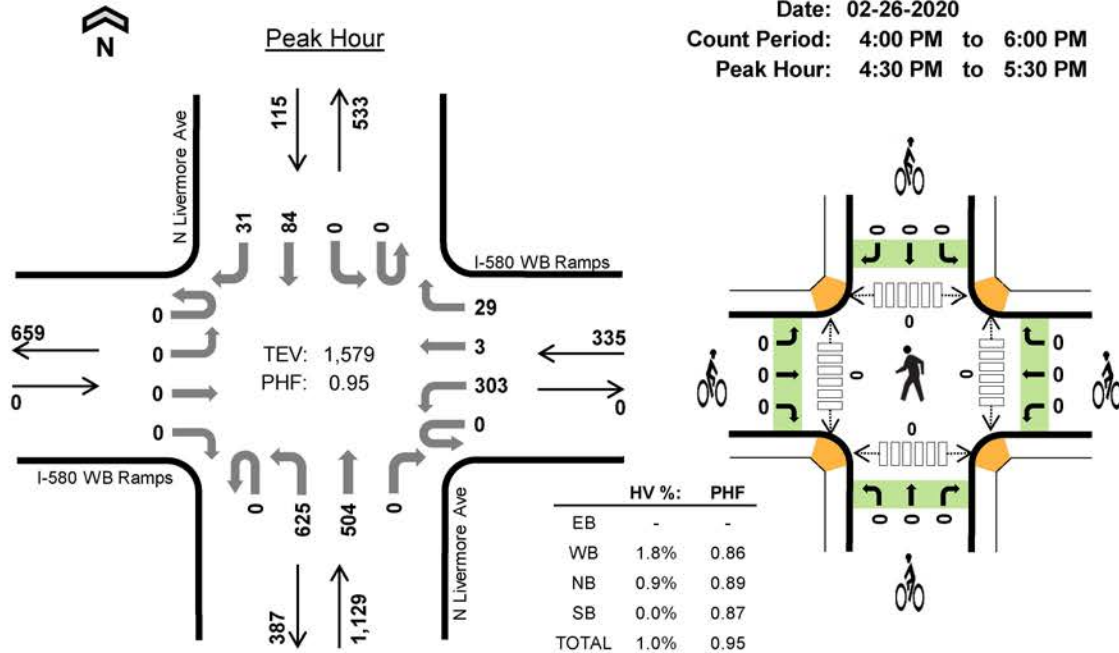

Two-Hour Count Summaries

Interval Start	I-580 WB Ramps Eastbound				I-580 WB Ramps Westbound				N Livermore Ave Northbound				N Livermore Ave Southbound				15-min Total	Rolling One Hour	
	UT	LT	TH	RT	UT	LT	TH	RT	UT	LT	TH	RT	UT	LT	TH	RT			
4:00 PM	0	0	0	0	0	69	0	5	0	124	106	0	0	0	25	8	337	0	
4:15 PM	0	0	0	0	0	73	4	4	0	121	106	0	0	0	10	2	320	0	
4:30 PM	0	0	0	0	0	76	0	9	0	150	114	0	0	0	16	12	377	0	
4:45 PM	0	0	0	0	0	90	1	6	0	134	131	0	0	0	26	7	395	1,429	
5:00 PM	0	0	0	0	0	60	2	5	0	192	125	0	0	0	23	8	415	1,507	
5:15 PM	0	0	0	0	0	77	0	9	0	149	134	0	0	0	19	4	392	1,579	
5:30 PM	0	0	0	0	0	71	2	4	0	138	116	0	0	0	25	6	362	1,564	
5:45 PM	0	0	0	0	0	65	1	3	0	160	90	0	0	0	23	8	350	1,519	
Count Total	0	0	0	0	0	581	10	45	0	1,168	922	0	0	0	167	55	2,948	0	
Peak Hour	All	0	0	0	0	0	303	3	29	0	625	504	0	0	0	84	31	1,579	0
	HV	0	0	0	0	0	5	0	1	0	9	1	0	0	0	0	0	16	0
	HV%	-	-	-	-	-	2%	0%	3%	-	1%	0%	-	-	-	0%	0%	1%	0

Note: Two-hour count summary volumes include heavy vehicles but exclude bicycles in overall count.

Interval Start	Heavy Vehicle Totals					Bicycles					Pedestrians (Crossing Leg)				
	EB	WB	NB	SB	Total	EB	WB	NB	SB	Total	East	West	North	South	Total
4:00 PM	0	1	5	0	6	0	0	0	0	0	0	0	0	0	0
4:15 PM	0	2	4	0	6	0	0	0	0	0	0	0	0	0	0
4:30 PM	0	1	4	0	5	0	0	0	0	0	0	0	0	0	0
4:45 PM	0	1	1	0	2	0	0	0	0	0	0	0	0	0	0
5:00 PM	0	1	3	0	4	0	0	0	0	0	0	0	0	0	0
5:15 PM	0	3	2	0	5	0	0	0	0	0	0	0	0	0	0
5:30 PM	0	0	3	1	4	0	0	0	0	0	0	0	0	0	0
5:45 PM	0	1	0	0	1	0	0	0	0	0	0	0	0	0	0
Count Total	0	10	22	1	33	0	0	0	0	0	0	0	0	0	0
Peak Hour	0	6	10	0	16	0	0	0	0	0	0	0	0	0	0

Two-Hour Count Summaries - Heavy Vehicles																		
Interval Start	I-580 WB Ramps				I-580 WB Ramps				N Livermore Ave				N Livermore Ave				15-min Total	Rolling One Hour
	Eastbound				Westbound				Northbound				Southbound					
	UT	LT	TH	RT	UT	LT	TH	RT	UT	LT	TH	RT	UT	LT	TH	RT		
4:00 PM	0	0	0	0	0	1	0	0	0	3	2	0	0	0	0	0	6	0
4:15 PM	0	0	0	0	0	1	1	0	0	3	1	0	0	0	0	0	6	0
4:30 PM	0	0	0	0	0	0	0	1	0	4	0	0	0	0	0	0	5	0
4:45 PM	0	0	0	0	0	1	0	0	0	1	0	0	0	0	0	0	2	19
5:00 PM	0	0	0	0	0	1	0	0	0	2	1	0	0	0	0	0	4	17
5:15 PM	0	0	0	0	0	3	0	0	0	2	0	0	0	0	0	0	5	16
5:30 PM	0	0	0	0	0	0	0	0	0	2	1	0	0	0	1	0	4	15
5:45 PM	0	0	0	0	0	1	0	0	0	0	0	0	0	0	0	0	1	14
Count Total	0	0	0	0	0	8	1	1	0	17	5	0	0	0	1	0	33	0
Peak Hour	0	0	0	0	0	5	0	1	0	9	1	0	0	0	0	0	16	0
Two-Hour Count Summaries - Bikes																		
Interval Start	I-580 WB Ramps			I-580 WB Ramps			N Livermore Ave			N Livermore Ave			15-min Total	Rolling One Hour				
	Eastbound			Westbound			Northbound			Southbound								
	LT	TH	RT	LT	TH	RT	LT	TH	RT	LT	TH	RT						
4:00 PM	0	0	0	0	0	0	0	0	0	0	0	0	0	0	0	0	0	0
4:15 PM	0	0	0	0	0	0	0	0	0	0	0	0	0	0	0	0	0	0
4:30 PM	0	0	0	0	0	0	0	0	0	0	0	0	0	0	0	0	0	0
4:45 PM	0	0	0	0	0	0	0	0	0	0	0	0	0	0	0	0	0	0
5:00 PM	0	0	0	0	0	0	0	0	0	0	0	0	0	0	0	0	0	0
5:15 PM	0	0	0	0	0	0	0	0	0	0	0	0	0	0	0	0	0	0
5:30 PM	0	0	0	0	0	0	0	0	0	0	0	0	0	0	0	0	0	0
5:45 PM	0	0	0	0	0	0	0	0	0	0	0	0	0	0	0	0	0	0
Count Total	0	0	0	0	0	0	0	0	0	0	0	0	0	0	0	0	0	0
Peak Hour	0	0	0	0	0	0	0	0	0	0	0	0	0	0	0	0	0	0
<i>Note: U-Turn volumes for bikes are included in Left-Turn, if any.</i>																		

N Livermore Ave I-580 EB Ramps



Date: 02-26-2020
Count Period: 4:00 PM to 6:00 PM
Peak Hour: 4:30 PM to 5:30 PM

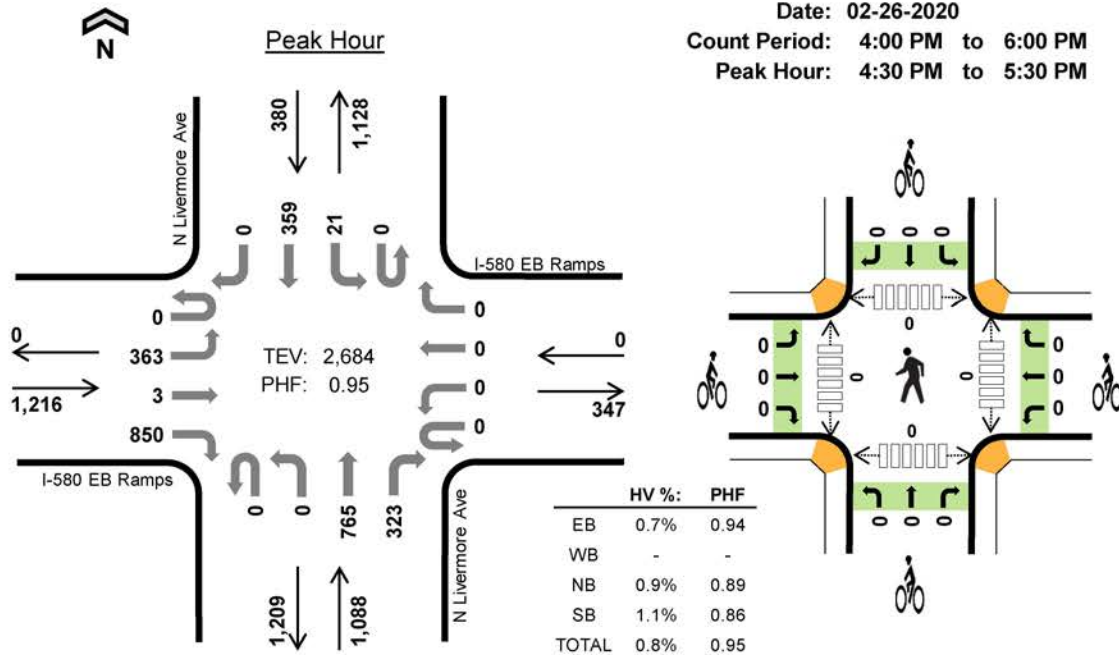

Two-Hour Count Summaries

Interval Start	I-580 EB Ramps Eastbound				I-580 EB Ramps Westbound				N Livermore Ave Northbound				N Livermore Ave Southbound				15-min Total	Rolling One Hour	
	UT	LT	TH	RT	UT	LT	TH	RT	UT	LT	TH	RT	UT	LT	TH	RT			
4:00 PM	0	75	1	182	0	0	0	0	0	0	164	79	0	4	90	0	595	0	
4:15 PM	0	77	2	195	0	0	0	0	0	0	154	78	0	2	81	0	589	0	
4:30 PM	0	77	3	205	0	0	0	0	0	0	180	89	0	5	93	0	652	0	
4:45 PM	0	104	0	207	0	0	0	0	0	0	160	75	0	8	103	0	657	2,493	
5:00 PM	0	91	0	231	0	0	0	0	0	0	230	76	0	3	76	0	707	2,605	
5:15 PM	0	91	0	207	0	0	0	0	0	0	195	83	0	5	87	0	668	2,684	
5:30 PM	0	74	1	207	0	0	0	0	0	0	173	78	0	8	89	0	630	2,662	
5:45 PM	0	60	1	229	0	0	0	0	0	0	182	62	0	5	86	0	625	2,630	
Count Total	0	649	8	1,663	0	0	0	0	0	0	1,438	620	0	40	705	0	5,123	0	
Peak Hour	All	0	363	3	850	0	0	0	0	0	0	765	323	0	21	359	0	2,684	0
	HV	0	2	0	6	0	0	0	0	0	0	8	2	0	1	3	0	22	0
	HV%	-	1%	0%	1%	-	-	-	-	-	-	1%	1%	-	5%	1%	-	1%	0

Note: Two-hour count summary volumes include heavy vehicles but exclude bicycles in overall count.

Interval Start	Heavy Vehicle Totals					Bicycles					Pedestrians (Crossing Leg)				
	EB	WB	NB	SB	Total	EB	WB	NB	SB	Total	East	West	North	South	Total
4:00 PM	2	0	4	1	7	0	0	0	0	0	0	0	0	0	0
4:15 PM	2	0	3	1	6	0	0	0	0	0	0	0	0	0	0
4:30 PM	1	0	5	0	6	0	0	0	0	0	0	0	0	0	0
4:45 PM	2	0	0	1	3	0	0	0	0	0	0	0	0	0	0
5:00 PM	3	0	2	1	6	0	0	0	0	0	0	0	0	0	0
5:15 PM	2	0	3	2	7	0	0	0	0	0	0	0	0	0	0
5:30 PM	2	0	2	1	5	0	0	0	0	0	0	0	0	0	0
5:45 PM	4	0	1	2	7	0	0	0	0	0	0	0	0	0	0
Count Total	18	0	20	9	47	0	0	0	0	0	0	0	0	0	0
Peak Hour	8	0	10	4	22	0	0	0	0	0	0	0	0	0	0

Two-Hour Count Summaries - Heavy Vehicles																		
Interval Start	I-580 EB Ramps				I-580 EB Ramps				N Livermore Ave				N Livermore Ave				15-min Total	Rolling One Hour
	Eastbound				Westbound				Northbound				Southbound					
	UT	LT	TH	RT	UT	LT	TH	RT	UT	LT	TH	RT	UT	LT	TH	RT		
4:00 PM	0	2	0	0	0	0	0	0	0	0	3	1	0	0	1	0	7	0
4:15 PM	0	1	0	1	0	0	0	0	0	0	3	0	0	0	1	0	6	0
4:30 PM	0	0	0	1	0	0	0	0	0	0	4	1	0	0	0	0	6	0
4:45 PM	0	1	0	1	0	0	0	0	0	0	0	0	0	1	0	0	3	22
5:00 PM	0	1	0	2	0	0	0	0	0	0	2	0	0	0	1	0	6	21
5:15 PM	0	0	0	2	0	0	0	0	0	0	2	1	0	0	2	0	7	22
5:30 PM	0	1	0	1	0	0	0	0	0	0	2	0	0	1	0	0	5	21
5:45 PM	0	0	0	4	0	0	0	0	0	0	0	1	0	0	2	0	7	25
Count Total	0	6	0	12	0	0	0	0	0	0	16	4	0	2	7	0	47	0
Peak Hour	0	2	0	6	0	0	0	0	0	0	8	2	0	1	3	0	22	0
Two-Hour Count Summaries - Bikes																		
Interval Start	I-580 EB Ramps			I-580 EB Ramps			N Livermore Ave			N Livermore Ave			15-min Total	Rolling One Hour				
	Eastbound			Westbound			Northbound			Southbound								
	LT	TH	RT	LT	TH	RT	LT	TH	RT	LT	TH	RT						
4:00 PM	0	0	0	0	0	0	0	0	0	0	0	0	0	0	0	0	0	0
4:15 PM	0	0	0	0	0	0	0	0	0	0	0	0	0	0	0	0	0	0
4:30 PM	0	0	0	0	0	0	0	0	0	0	0	0	0	0	0	0	0	0
4:45 PM	0	0	0	0	0	0	0	0	0	0	0	0	0	0	0	0	0	0
5:00 PM	0	0	0	0	0	0	0	0	0	0	0	0	0	0	0	0	0	0
5:15 PM	0	0	0	0	0	0	0	0	0	0	0	0	0	0	0	0	0	0
5:30 PM	0	0	0	0	0	0	0	0	0	0	0	0	0	0	0	0	0	0
5:45 PM	0	0	0	0	0	0	0	0	0	0	0	0	0	0	0	0	0	0
Count Total	0	0	0	0	0	0	0	0	0	0	0	0	0	0	0	0	0	0
Peak Hour	0	0	0	0	0	0	0	0	0	0	0	0	0	0	0	0	0	0
<i>Note: U-Turn volumes for bikes are included in Left-Turn, if any.</i>																		

APPENDIX C – EXISTING CONDITIONS LOS AND QUEUE LENGTH CALCULATIONS

Aramis Solar Project TIS
 1: Manning Rd & Morgan Territory Rd

03/20/2020



Movement	EBL	EBT	WBT	WBR	SBL	SBR
Lane Configurations		↕	↔		↕	
Traffic Volume (veh/h)	0	36	153	4	30	8
Future Volume (Veh/h)	0	36	153	4	30	8
Sign Control		Free	Free		Stop	
Grade		0%	0%		0%	
Peak Hour Factor	0.85	0.85	0.85	0.85	0.85	0.85
Hourly flow rate (vph)	0	42	180	5	35	9
Pedestrians			1			
Lane Width (ft)			12.0			
Walking Speed (ft/s)			3.5			
Percent Blockage			0			
Right turn flare (veh)						
Median type		None	None			
Median storage (veh)						
Upstream signal (ft)						
pX, platoon unblocked						
vC, conflicting volume	185				226	182
vC1, stage 1 conf vol						
vC2, stage 2 conf vol						
vCu, unblocked vol	185				226	182
tC, single (s)	4.1				6.4	6.2
tC, 2 stage (s)						
tF (s)	2.2				3.5	3.3
p0 queue free %	100				95	99
cM capacity (veh/h)	1390				762	860
Direction, Lane #	EB 1	WB 1	SB 1			
Volume Total	42	185	44			
Volume Left	0	0	35			
Volume Right	0	5	9			
cSH	1390	1700	780			
Volume to Capacity	0.00	0.11	0.06			
Queue Length 95th (ft)	0	0	4			
Control Delay (s)	0.0	0.0	9.9			
Lane LOS			A			
Approach Delay (s)	0.0	0.0	9.9			
Approach LOS			A			
Intersection Summary						
Average Delay			1.6			
Intersection Capacity Utilization		18.3%		ICU Level of Service		A
Analysis Period (min)			15			

Aramis Solar Project TIS

2: N Livermore Ave & I-580 WB On-ramp/I-580 WB Off-ramp

03/20/2020

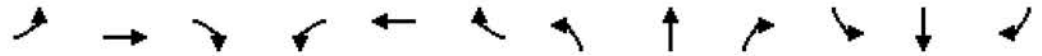

Movement	EBL	EBT	EBR	WBL	WBT	WBR	NBL	NBT	NBR	SBL	SBT	SBR
Lane Configurations				↖	↔		↗	↑			↕	↘
Traffic Volume (vph)	0	0	0	361	4	24	642	118	0	0	185	141
Future Volume (vph)	0	0	0	361	4	24	642	118	0	0	185	141
Ideal Flow (vphpl)	1900	1900	1900	1900	1900	1900	1900	1900	1900	1900	1900	1900
Total Lost time (s)				4.7	4.7		4.2	6.2			6.2	6.2
Lane Util. Factor				0.95	0.95		0.97	1.00			0.95	1.00
Frt				1.00	0.98		1.00	1.00			1.00	0.85
Flt Protected				0.95	0.96		0.95	1.00			1.00	1.00
Satd. Flow (prot)				1681	1665		3433	1863			3539	1583
Flt Permitted				0.95	0.96		0.95	1.00			1.00	1.00
Satd. Flow (perm)				1681	1665		3433	1863			3539	1583
Peak-hour factor, PHF	0.96	0.96	0.96	0.96	0.96	0.96	0.96	0.96	0.96	0.96	0.96	0.96
Adj. Flow (vph)	0	0	0	376	4	25	669	123	0	0	193	147
RTOR Reduction (vph)	0	0	0	0	10	0	0	0	0	0	0	105
Lane Group Flow (vph)	0	0	0	203	192	0	669	123	0	0	193	42
Turn Type				Perm	NA		Prot	NA			NA	Perm
Protected Phases					8		5	2			6	
Permitted Phases				8								6
Actuated Green, G (s)				10.8	10.8		15.0	35.3			16.1	16.1
Effective Green, g (s)				10.8	10.8		15.0	35.3			16.1	16.1
Actuated g/C Ratio				0.19	0.19		0.26	0.62			0.28	0.28
Clearance Time (s)				4.7	4.7		4.2	6.2			6.2	6.2
Vehicle Extension (s)				2.0	2.0		2.0	2.5			2.5	2.5
Lane Grp Cap (vph)				318	315		903	1153			999	447
v/s Ratio Prot							c0.19	0.07			c0.05	
v/s Ratio Perm				c0.12	0.12							0.03
v/c Ratio				0.64	0.61		0.74	0.11			0.19	0.09
Uniform Delay, d1				21.3	21.2		19.2	4.4			15.5	15.1
Progression Factor				1.00	1.00		0.66	0.97			1.00	1.00
Incremental Delay, d2				3.1	2.5		2.6	0.2			0.4	0.4
Delay (s)				24.4	23.6		15.4	4.5			16.0	15.5
Level of Service				C	C		B	A			B	B
Approach Delay (s)		0.0			24.0			13.7			15.7	
Approach LOS		A			C			B			B	

Intersection Summary			
HCM 2000 Control Delay	16.9	HCM 2000 Level of Service	B
HCM 2000 Volume to Capacity ratio	0.50		
Actuated Cycle Length (s)	57.0	Sum of lost time (s)	15.1
Intersection Capacity Utilization	57.4%	ICU Level of Service	B
Analysis Period (min)	15		

c Critical Lane Group

Aramis Solar Project TIS

3: N Livermore Ave & I-580 EB Off-ramp/I-580 EB On-ramp

03/20/2020

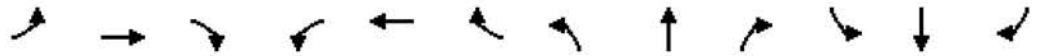

Movement	EBL	EBT	EBR	WBL	WBT	WBR	NBL	NBT	NBR	SBL	SBT	SBR
Lane Configurations		↕	↗					↕		↗	↕	
Traffic Volume (vph)	34	3	579	0	0	0	0	747	243	24	515	0
Future Volume (vph)	34	3	579	0	0	0	0	747	243	24	515	0
Ideal Flow (vphpl)	1900	1900	1900	1900	1900	1900	1900	1900	1900	1900	1900	1900
Total Lost time (s)		4.7	4.7					5.4		3.7	5.4	
Lane Util. Factor		0.95	0.95					0.95		1.00	0.95	
Frt		0.87	0.85					0.96		1.00	1.00	
Flt Protected		0.99	1.00					1.00		0.95	1.00	
Satd. Flow (prot)		1527	1504					3409		1770	3539	
Flt Permitted		0.99	1.00					1.00		0.95	1.00	
Satd. Flow (perm)		1527	1504					3409		1770	3539	
Peak-hour factor, PHF	0.96	0.96	0.96	0.96	0.96	0.96	0.96	0.96	0.96	0.96	0.96	0.96
Adj. Flow (vph)	35	3	603	0	0	0	0	778	253	25	536	0
RTOR Reduction (vph)	0	243	245	0	0	0	0	32	0	0	0	0
Lane Group Flow (vph)	0	78	76	0	0	0	0	999	0	25	536	0
Turn Type	Split	NA	Prot					NA		Prot	NA	
Protected Phases	4	4	4					2		1	6	
Permitted Phases												
Actuated Green, G (s)		8.1	8.1					33.7		1.4	38.8	
Effective Green, g (s)		8.1	8.1					33.7		1.4	38.8	
Actuated g/C Ratio		0.14	0.14					0.59		0.02	0.68	
Clearance Time (s)		4.7	4.7					5.4		3.7	5.4	
Vehicle Extension (s)		2.0	2.0					2.5		2.0	2.5	
Lane Grp Cap (vph)		216	213					2015		43	2409	
v/s Ratio Prot		c0.05	0.05					c0.29		c0.01	0.15	
v/s Ratio Perm												
v/c Ratio		0.36	0.35					0.50		0.58	0.22	
Uniform Delay, d1		22.1	22.1					6.7		27.5	3.4	
Progression Factor		1.00	1.00					1.00		1.13	0.22	
Incremental Delay, d2		0.4	0.4					0.9		11.5	0.2	
Delay (s)		22.5	22.5					7.6		42.7	1.0	
Level of Service		C	C					A		D	A	
Approach Delay (s)		22.5			0.0			7.6			2.8	
Approach LOS		C			A			A			A	

Intersection Summary

HCM 2000 Control Delay	10.7	HCM 2000 Level of Service	B
HCM 2000 Volume to Capacity ratio	0.47		
Actuated Cycle Length (s)	57.0	Sum of lost time (s)	13.8
Intersection Capacity Utilization	57.4%	ICU Level of Service	B
Analysis Period (min)	15		

c Critical Lane Group

Aramis Solar Project TIS
 1: Manning Rd & Morgan Territory Rd

03/25/2020



Movement	EBL	EBT	WBT	WBR	SBL	SBR
Lane Configurations						
Traffic Volume (veh/h)	7	209	43	43	14	0
Future Volume (Veh/h)	7	209	43	43	14	0
Sign Control		Free	Free		Stop	
Grade		0%	0%		0%	
Peak Hour Factor	0.85	0.85	0.85	0.85	0.85	0.85
Hourly flow rate (vph)	8	246	51	51	16	0
Pedestrians			1			
Lane Width (ft)			12.0			
Walking Speed (ft/s)			3.5			
Percent Blockage			0			
Right turn flare (veh)						
Median type		None	None			
Median storage (veh)						
Upstream signal (ft)						
pX, platoon unblocked						
vC, conflicting volume	102				340	76
vC1, stage 1 conf vol						
vC2, stage 2 conf vol						
vCu, unblocked vol	102				340	76
tC, single (s)	4.1				6.4	6.2
tC, 2 stage (s)						
tF (s)	2.2				3.5	3.3
p0 queue free %	99				98	100
cM capacity (veh/h)	1490				652	985
Direction, Lane #	EB 1	WB 1	SB 1			
Volume Total	254	102	16			
Volume Left	8	0	16			
Volume Right	0	51	0			
cSH	1490	1700	652			
Volume to Capacity	0.01	0.06	0.02			
Queue Length 95th (ft)	0	0	2			
Control Delay (s)	0.3	0.0	10.7			
Lane LOS	A		B			
Approach Delay (s)	0.3	0.0	10.7			
Approach LOS			B			
Intersection Summary						
Average Delay			0.6			
Intersection Capacity Utilization		26.7%		ICU Level of Service		A
Analysis Period (min)			15			

Aramis Solar Project TIS

2: N Livermore Ave & I-580 WB On-ramp/I-580 WB Off-ramp

03/25/2020

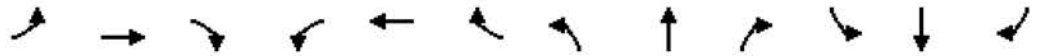

Movement	EBL	EBT	EBR	WBL	WBT	WBR	NBL	NBT	NBR	SBL	SBT	SBR
Lane Configurations				↖	↔		↗	↑			↕	↘
Traffic Volume (vph)	0	0	0	303	3	29	625	504	0	0	84	31
Future Volume (vph)	0	0	0	303	3	29	625	504	0	0	84	31
Ideal Flow (vphpl)	1900	1900	1900	1900	1900	1900	1900	1900	1900	1900	1900	1900
Total Lost time (s)				4.7	4.7		4.2	6.2			6.2	6.2
Lane Util. Factor				0.95	0.95		0.97	1.00			0.95	1.00
Fr _t				1.00	0.97		1.00	1.00			1.00	0.85
Fl _t Protected				0.95	0.96		0.95	1.00			1.00	1.00
Satd. Flow (prot)				1681	1656		3433	1863			3539	1583
Fl _t Permitted				0.95	0.96		0.95	1.00			1.00	1.00
Satd. Flow (perm)				1681	1656		3433	1863			3539	1583
Peak-hour factor, PHF	0.96	0.96	0.96	0.96	0.96	0.96	0.96	0.96	0.96	0.96	0.96	0.96
Adj. Flow (vph)	0	0	0	316	3	30	651	525	0	0	88	32
RTOR Reduction (vph)	0	0	0	0	13	0	0	0	0	0	0	21
Lane Group Flow (vph)	0	0	0	177	159	0	651	525	0	0	88	11
Turn Type				Perm	NA		Prot	NA			NA	Perm
Protected Phases					8		5	2			6	
Permitted Phases				8								6
Actuated Green, G (s)				11.3	11.3		16.7	42.8			21.9	21.9
Effective Green, g (s)				11.3	11.3		16.7	42.8			21.9	21.9
Actuated g/C Ratio				0.17	0.17		0.26	0.66			0.34	0.34
Clearance Time (s)				4.7	4.7		4.2	6.2			6.2	6.2
Vehicle Extension (s)				2.0	2.0		2.0	2.5			2.5	2.5
Lane Grp Cap (vph)				292	287		882	1226			1192	533
v/s Ratio Prot							c0.19	c0.28			0.02	
v/s Ratio Perm				c0.11	0.10							0.01
v/c Ratio				0.61	0.55		0.74	0.43			0.07	0.02
Uniform Delay, d ₁				24.8	24.5		22.1	5.3			14.7	14.4
Progression Factor				1.00	1.00		0.90	0.68			1.00	1.00
Incremental Delay, d ₂				2.4	1.3		1.5	0.6			0.1	0.1
Delay (s)				27.2	25.9		21.4	4.2			14.8	14.5
Level of Service				C	C		C	A			B	B
Approach Delay (s)		0.0			26.6			13.7			14.7	
Approach LOS		A			C			B			B	

Intersection Summary

HCM 2000 Control Delay	16.5	HCM 2000 Level of Service	B
HCM 2000 Volume to Capacity ratio	0.59		
Actuated Cycle Length (s)	65.0	Sum of lost time (s)	15.1
Intersection Capacity Utilization	89.3%	ICU Level of Service	E
Analysis Period (min)	15		

c Critical Lane Group

Aramis Solar Project TIS

3: N Livermore Ave & I-580 EB Off-ramp/I-580 EB On-ramp

03/25/2020

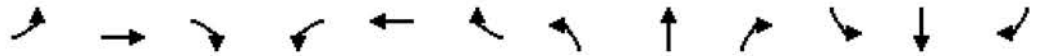

Movement	EBL	EBT	EBR	WBL	WBT	WBR	NBL	NBT	NBR	SBL	SBT	SBR
Lane Configurations		↕	↗					↕		↗	↕	
Traffic Volume (vph)	363	3	850	0	0	0	0	765	323	21	359	0
Future Volume (vph)	363	3	850	0	0	0	0	765	323	21	359	0
Ideal Flow (vphpl)	1900	1900	1900	1900	1900	1900	1900	1900	1900	1900	1900	1900
Total Lost time (s)		4.7	4.7					5.4		3.7	5.4	
Lane Util. Factor		0.95	0.95					0.95		1.00	0.95	
Frt		0.94	0.85					0.96		1.00	1.00	
Flt Protected		0.97	1.00					1.00		0.95	1.00	
Satd. Flow (prot)		1612	1504					3382		1770	3539	
Flt Permitted		0.97	1.00					1.00		0.95	1.00	
Satd. Flow (perm)		1612	1504					3382		1770	3539	
Peak-hour factor, PHF	0.96	0.96	0.96	0.96	0.96	0.96	0.96	0.96	0.96	0.96	0.96	0.96
Adj. Flow (vph)	378	3	885	0	0	0	0	797	336	22	374	0
RTOR Reduction (vph)	0	40	218	0	0	0	0	59	0	0	0	0
Lane Group Flow (vph)	0	615	393	0	0	0	0	1074	0	22	374	0
Turn Type	Split	NA	Prot					NA		Prot	NA	
Protected Phases	4	4	4					2		1	6	
Permitted Phases												
Actuated Green, G (s)		25.9	25.9					23.9		1.4	29.0	
Effective Green, g (s)		25.9	25.9					23.9		1.4	29.0	
Actuated g/C Ratio		0.40	0.40					0.37		0.02	0.45	
Clearance Time (s)		4.7	4.7					5.4		3.7	5.4	
Vehicle Extension (s)		2.0	2.0					2.5		2.0	2.5	
Lane Grp Cap (vph)		642	599					1243		38	1578	
v/s Ratio Prot		c0.38	0.26					c0.32		c0.01	0.11	
v/s Ratio Perm												
v/c Ratio		0.96	0.66					0.86		0.58	0.24	
Uniform Delay, d1		19.0	15.9					19.0		31.5	11.1	
Progression Factor		1.00	1.00					1.00		0.37	0.75	
Incremental Delay, d2		24.9	2.0					8.1		12.1	0.3	
Delay (s)		44.0	17.9					27.1		23.6	8.6	
Level of Service		D	B					C		C	A	
Approach Delay (s)		31.4			0.0			27.1			9.5	
Approach LOS		C			A			C			A	

Intersection Summary		
HCM 2000 Control Delay	26.6	HCM 2000 Level of Service C
HCM 2000 Volume to Capacity ratio	0.90	
Actuated Cycle Length (s)	65.0	Sum of lost time (s) 13.8
Intersection Capacity Utilization	89.3%	ICU Level of Service E
Analysis Period (min)	15	

c Critical Lane Group



Lane Group	WBL	WBT	NBL	NBT	SBT	SBR
Lane Group Flow (vph)	203	202	669	123	193	147
v/c Ratio	0.64	0.62	0.74	0.11	0.19	0.27
Control Delay	30.3	28.1	17.6	5.3	18.4	6.0
Queue Delay	0.0	0.0	0.0	0.0	0.0	0.0
Total Delay	30.3	28.1	17.6	5.3	18.4	6.0
Queue Length 50th (ft)	67	62	106	25	26	0
Queue Length 95th (ft)	120	114	12	3	55	40
Internal Link Dist (ft)		347		287	361	
Turn Bay Length (ft)						140
Base Capacity (vph)	406	411	1072	1156	1006	555
Starvation Cap Reductn	0	0	0	0	0	0
Spillback Cap Reductn	0	0	0	0	0	0
Storage Cap Reductn	0	0	0	0	0	0
Reduced v/c Ratio	0.50	0.49	0.62	0.11	0.19	0.26

Intersection Summary



Lane Group	EBT	EBR	NBT	SBL	SBT
Lane Group Flow (vph)	321	320	1031	25	536
v/c Ratio	0.70	0.70	0.46	0.15	0.22
Control Delay	13.1	13.0	7.9	28.2	1.1
Queue Delay	0.0	0.0	0.0	0.0	0.0
Total Delay	13.1	13.0	7.9	28.2	1.1
Queue Length 50th (ft)	12	11	49	7	0
Queue Length 95th (ft)	66	65	214	m16	0
Internal Link Dist (ft)	984		364		287
Turn Bay Length (ft)					
Base Capacity (vph)	660	654	2219	288	2406
Starvation Cap Reductn	0	0	0	0	0
Spillback Cap Reductn	0	0	0	0	0
Storage Cap Reductn	0	0	0	0	0
Reduced v/c Ratio	0.49	0.49	0.46	0.09	0.22

Intersection Summary

m Volume for 95th percentile queue is metered by upstream signal.



Lane Group	WBL	WBT	NBL	NBT	SBT	SBR
Lane Group Flow (vph)	177	172	651	525	88	32
v/c Ratio	0.61	0.57	0.74	0.43	0.07	0.05
Control Delay	33.0	29.1	22.5	4.9	18.4	0.2
Queue Delay	0.0	0.0	0.0	0.6	0.0	0.0
Total Delay	33.0	29.1	22.5	5.5	18.4	0.2
Queue Length 50th (ft)	69	60	90	62	12	0
Queue Length 95th (ft)	115	106	m105	m80	33	0
Internal Link Dist (ft)		347		287	361	
Turn Bay Length (ft)						140
Base Capacity (vph)	423	428	1204	1229	1193	599
Starvation Cap Reductn	0	0	0	367	0	0
Spillback Cap Reductn	0	0	0	0	0	0
Storage Cap Reductn	0	0	0	0	0	0
Reduced v/c Ratio	0.42	0.40	0.54	0.61	0.07	0.05

Intersection Summary

m Volume for 95th percentile queue is metered by upstream signal.



Lane Group	EBT	EBR	NBT	SBL	SBT
Lane Group Flow (vph)	655	611	1133	22	374
v/c Ratio	0.96	0.75	0.78	0.15	0.24
Control Delay	45.8	13.3	22.4	12.1	8.9
Queue Delay	0.0	0.0	0.0	0.0	0.0
Total Delay	45.8	13.3	22.4	12.1	8.9
Queue Length 50th (ft)	231	73	170	3	21
Queue Length 95th (ft)	#454	208	#384	m8	29
Internal Link Dist (ft)	984		364		287
Turn Bay Length (ft)					
Base Capacity (vph)	692	824	1455	253	1579
Starvation Cap Reductn	0	0	0	0	0
Spillback Cap Reductn	0	0	0	0	0
Storage Cap Reductn	0	0	0	0	0
Reduced v/c Ratio	0.95	0.74	0.78	0.09	0.24

Intersection Summary

95th percentile volume exceeds capacity, queue may be longer.

Queue shown is maximum after two cycles.

m Volume for 95th percentile queue is metered by upstream signal.

APPENDIX D – DETAILED PROJECT TRIP GENERATION CALCULATIONS

Aramis Renewable Energy Project - Construction Phasing and Trip Assumptions

Phase	Duration (business days)	Start (week number)	End (week number)	Start (calendar day number)	Start (calendar day number)	Trips/day	Onroad trips/day
Site Prep	30	0	6	0	42	58	25
PV Installation	150	7	30	49	210	57	55
Electrical + Gen-tie	75	20	35	140	245	16	12
Vehicles and Equipment Used Throughout Construction & Restoration	175	0	35	0	245	0	0

	Vehicle	Onroad?	Phase	Total one-way trips
Modules	Flatbed	Yes	2	5000
Foundation posts	Flatbed	Yes	2	1000
Racking	Flatbed	Yes	2	1200
Cable	Flatbed	Yes	3	150
Interters	Flatbed	Yes	3	225
Transformers	Flatbed	Yes	3	200
Concrete	Concrete mixer	No	2	400
Road base	Dump truck	No	1	1000
Trash haul off	Haul	Yes	4	125
Fencing	Flatbed	Yes	1	50
Offroad eq transp	Flatbed	Yes	1	300
Electrical equip	Flatbed	No	3	125
Water	Tank truck	No	4	10000
Worker commute	Passenger car	Yes	1	400
Worker commute	Passenger car	Yes	2	1000
Worker commute	Passenger car	Yes	3	500

Aramis Renewable Energy Project - Trip Generation by Construction Phase

Phase	Trip Type	Trips Per Day	AM Peak	PM Peak
Phase I	Workers	400	100	100
	Haul Trips	46	5	5
	Total	446	105	105
Phase II	Workers	1000	250	250
	Haul Trips	52	6	6
	Total	1052	256	256
Phase III	Workers	500	125	125
	Haul Trips	10	1	1
	Total	510	126	126
Phase IV	Workers	-	-	-
	Haul Trips	59	7	7
	Total	59	7	7
Max Trips	Workers	1500	375	375
	Haul Trips	121	14	14
	Total	1621	389	389

Notes

1. Phase 4 occurs simultaneously to Phases 1-3.
2. Worker trips assume 4 worker trips per day (AM in, lunch break in/out, PM out)

Aramis Renewable Energy Project - Trip Distribution Calculations

Trips	AM				PM			
	Inbound		Outbound		Inbound		Outbound	
Total Worker Trips	375						375	
580 Worker Trips	338	80%					338	80%
<i>580 WB Worker Trips</i>	49	13%					252	67%
<i>580 EB Worker Trips</i>	252	67%					49	13%
Non-580 Worker Trips	76	20%					76	20%
<i>Manning (to/from north)</i>	38	10%					38	10%
<i>Livermore (to/from south)</i>	38	10%					38	10%
Total Haul Trips	7		7		7		7	
<i>580 WB Haul Trips</i>			7	50%			7	50%
<i>580 EB Haul Trips</i>	7	50%			7	50%	0	
Total EB 580 Trips	259	68%			7	2%	49	13%
Total WB 580 Trips	49	13%	7	2%			259	68%
Total SB Manning	38	10%					38	10%
Total NB North Livermore	38	10%					38	10%
Total Trips	384	99%	7	2%	7	2%	384	99%

Notes

1. All haul trips arrive to and depart from the Port of Oakland
2. 20% of worker trips assumed to not depart/arrive via I-580. All other worker trips assumed to arrive via I-580.
3. Worker trip origin/destination assumes even distribution from 5 East Bay cities (per sponsor data): Oakland, San Leandro, Hayward, Fremont, and Tracy.

City	Gen Population		Worker Population		Worker Population by Industry	
Oakland	429,114	43%	235,825	44%	13,727	42%
San Leandro	89,683	9%	48,974	9%	3,740	11%
Hayward	159,618	16%	78,738	15%	6,441	20%
Fremont	237,815	24%	124,130	23%	3,872	12%
Tracy	91,803	9%	47,555	9%	4,885	15%
Total	1,008,033	100%	535,222	100%	32,665	100%

Source: US Census Bureau - American Community Survey (ACS)

- General Population by Age (2018)
- Class of Worker for Civilian Employed Population 16 Years+ (2018)
- Industry for the Civilian Employed Population 16 Years+ (2018)

APPENDIX E – EXISTING PLUS PROJECT CONDITIONS LOS AND QUEUE LENGTH CALCULATIONS

Aramis Solar Project TIS
 1: Manning Rd & Morgan Territory Rd

08/31/2020

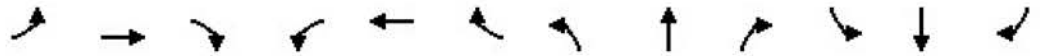

Movement	EBL	EBT	EBR	WBL	WBT	WBR	NBL	NBT	NBR	SBL	SBT	SBR
Lane Configurations		↕			↕			↕			↕	
Traffic Volume (veh/h)	0	74	0	1	153	4	0	0	0	30	0	8
Future Volume (Veh/h)	0	74	0	1	153	4	0	0	0	30	0	8
Sign Control		Free			Free			Stop			Stop	
Grade		0%			0%			0%			0%	
Peak Hour Factor	0.85	0.85	0.92	0.92	0.85	0.85	0.92	0.92	0.92	0.85	0.92	0.85
Hourly flow rate (vph)	0	87	0	1	180	5	0	0	0	35	0	9
Pedestrians					1							
Lane Width (ft)					12.0							
Walking Speed (ft/s)					3.5							
Percent Blockage					0							
Right turn flare (veh)												
Median type		None			None							
Median storage (veh)												
Upstream signal (ft)												
pX, platoon unblocked												
vC, conflicting volume	185			87			280	274	88	272	272	182
vC1, stage 1 conf vol												
vC2, stage 2 conf vol												
vCu, unblocked vol	185			87			280	274	88	272	272	182
tC, single (s)	4.1			4.1			7.1	6.5	6.2	7.1	6.5	6.2
tC, 2 stage (s)												
tF (s)	2.2			2.2			3.5	4.0	3.3	3.5	4.0	3.3
p0 queue free %	100			100			100	100	100	95	100	99
cM capacity (veh/h)	1390			1509			664	633	969	679	635	860
Direction, Lane #	EB 1	WB 1	NB 1	SB 1								
Volume Total	87	186	0	44								
Volume Left	0	1	0	35								
Volume Right	0	5	0	9								
cSH	1390	1509	1700	710								
Volume to Capacity	0.00	0.00	0.00	0.06								
Queue Length 95th (ft)	0	0	0	5								
Control Delay (s)	0.0	0.0	0.0	10.4								
Lane LOS		A	A	B								
Approach Delay (s)	0.0	0.0	0.0	10.4								
Approach LOS			A	B								
Intersection Summary												
Average Delay			1.5									
Intersection Capacity Utilization			19.1%		ICU Level of Service				A			
Analysis Period (min)			15									

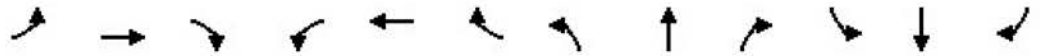

Movement	EBL	EBT	EBR	WBL	WBT	WBR	NBL	NBT	NBR	SBL	SBT	SBR
Lane Configurations				↖	↔		↗	↑			↕	↘
Traffic Volume (vph)	0	0	0	361	4	73	642	415	0	0	185	148
Future Volume (vph)	0	0	0	361	4	73	642	415	0	0	185	148
Ideal Flow (vphpl)	1900	1900	1900	1900	1900	1900	1900	1900	1900	1900	1900	1900
Total Lost time (s)				4.7	4.7		4.2	6.2			6.2	6.2
Lane Util. Factor				0.95	0.95		0.97	1.00			0.95	1.00
Fr _t				1.00	0.95		1.00	1.00			1.00	0.85
Fl _t Protected				0.95	0.97		0.95	1.00			1.00	1.00
Satd. Flow (prot)				1681	1627		3433	1863			3539	1583
Fl _t Permitted				0.95	0.97		0.95	1.00			1.00	1.00
Satd. Flow (perm)				1681	1627		3433	1863			3539	1583
Peak-hour factor, PHF	0.96	0.96	0.96	0.96	0.96	0.96	0.96	0.96	0.96	0.96	0.96	0.96
Adj. Flow (vph)	0	0	0	376	4	76	669	432	0	0	193	154
RTOR Reduction (vph)	0	0	0	0	34	0	0	0	0	0	0	113
Lane Group Flow (vph)	0	0	0	233	189	0	669	432	0	0	193	41
Turn Type				Perm	NA		Prot	NA			NA	Perm
Protected Phases					8		5	2			6	
Permitted Phases				8								6
Actuated Green, G (s)				11.6	11.6		15.0	34.5			15.3	15.3
Effective Green, g (s)				11.6	11.6		15.0	34.5			15.3	15.3
Actuated g/C Ratio				0.20	0.20		0.26	0.61			0.27	0.27
Clearance Time (s)				4.7	4.7		4.2	6.2			6.2	6.2
Vehicle Extension (s)				2.0	2.0		2.0	2.5			2.5	2.5
Lane Grp Cap (vph)				342	331		903	1127			949	424
v/s Ratio Prot							c0.19	c0.23			0.05	
v/s Ratio Perm				c0.14	0.12							0.03
v/c Ratio				0.68	0.57		0.74	0.38			0.20	0.10
Uniform Delay, d ₁				21.0	20.5		19.2	5.8			16.1	15.7
Progression Factor				1.00	1.00		0.73	0.89			1.00	1.00
Incremental Delay, d ₂				4.4	1.5		2.1	0.7			0.5	0.5
Delay (s)				25.4	21.9		16.1	5.9			16.6	16.1
Level of Service				C	C		B	A			B	B
Approach Delay (s)		0.0			23.7			12.1			16.4	
Approach LOS		A			C			B			B	

Intersection Summary			
HCM 2000 Control Delay	15.7	HCM 2000 Level of Service	B
HCM 2000 Volume to Capacity ratio	0.62		
Actuated Cycle Length (s)	57.0	Sum of lost time (s)	15.1
Intersection Capacity Utilization	82.8%	ICU Level of Service	E
Analysis Period (min)	15		

c Critical Lane Group

Aramis Solar Project TIS

3: N Livermore Ave & I-580 EB Off-ramp/I-580 EB On-ramp

08/31/2020

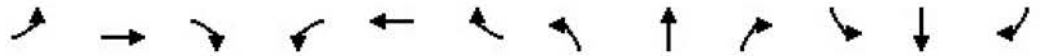

Movement	EBL	EBT	EBR	WBL	WBT	WBR	NBL	NBT	NBR	SBL	SBT	SBR
Lane Configurations		↕	↗					↕↗		↗	↕↗	
Traffic Volume (vph)	293	3	579	0	0	0	0	785	243	24	515	0
Future Volume (vph)	293	3	579	0	0	0	0	785	243	24	515	0
Ideal Flow (vphpl)	1900	1900	1900	1900	1900	1900	1900	1900	1900	1900	1900	1900
Total Lost time (s)		4.7	4.7					5.4		3.7	5.4	
Lane Util. Factor		0.95	0.95					0.95		1.00	0.95	
Frt		0.95	0.85					0.96		1.00	1.00	
Flt Protected		0.97	1.00					1.00		0.95	1.00	
Satd. Flow (prot)		1625	1504					3414		1770	3539	
Flt Permitted		0.97	1.00					1.00		0.95	1.00	
Satd. Flow (perm)		1625	1504					3414		1770	3539	
Peak-hour factor, PHF	0.96	0.96	0.96	0.96	0.96	0.96	0.96	0.96	0.96	0.96	0.96	0.96
Adj. Flow (vph)	305	3	603	0	0	0	0	818	253	25	536	0
RTOR Reduction (vph)	0	34	202	0	0	0	0	40	0	0	0	0
Lane Group Flow (vph)	0	437	239	0	0	0	0	1031	0	25	536	0
Turn Type	Split	NA	Prot					NA		Prot	NA	
Protected Phases	4	4	4					2		1	6	
Permitted Phases												
Actuated Green, G (s)		16.7	16.7					25.1		1.4	30.2	
Effective Green, g (s)		16.7	16.7					25.1		1.4	30.2	
Actuated g/C Ratio		0.29	0.29					0.44		0.02	0.53	
Clearance Time (s)		4.7	4.7					5.4		3.7	5.4	
Vehicle Extension (s)		2.0	2.0					2.5		2.0	2.5	
Lane Grp Cap (vph)		476	440					1503		43	1875	
v/s Ratio Prot		c0.27	0.16					c0.30		c0.01	0.15	
v/s Ratio Perm												
v/c Ratio		0.92	0.54					0.69		0.58	0.29	
Uniform Delay, d1		19.5	16.9					12.8		27.5	7.4	
Progression Factor		1.00	1.00					1.00		1.28	0.45	
Incremental Delay, d2		22.2	0.7					2.6		11.3	0.4	
Delay (s)		41.7	17.7					15.4		46.6	3.7	
Level of Service		D	B					B		D	A	
Approach Delay (s)		30.1			0.0			15.4			5.6	
Approach LOS		C			A			B			A	

Intersection Summary		
HCM 2000 Control Delay	18.5	HCM 2000 Level of Service B
HCM 2000 Volume to Capacity ratio	0.77	
Actuated Cycle Length (s)	57.0	Sum of lost time (s) 13.8
Intersection Capacity Utilization	82.8%	ICU Level of Service E
Analysis Period (min)	15	

c Critical Lane Group



Lane Group	WBL	WBT	NBL	NBT	SBT	SBR
Lane Group Flow (vph)	233	223	669	432	193	154
v/c Ratio	0.68	0.61	0.74	0.38	0.20	0.29
Control Delay	31.2	23.5	17.9	6.7	19.1	6.1
Queue Delay	0.0	0.0	0.0	0.5	0.0	0.0
Total Delay	31.2	23.5	17.9	7.2	19.1	6.1
Queue Length 50th (ft)	76	57	114	96	27	0
Queue Length 95th (ft)	136	114	m57	m31	55	40
Internal Link Dist (ft)		347		287	361	
Turn Bay Length (ft)						140
Base Capacity (vph)	413	432	1072	1137	961	541
Starvation Cap Reductn	0	0	0	329	0	0
Spillback Cap Reductn	0	0	0	0	0	0
Storage Cap Reductn	0	0	0	0	0	0
Reduced v/c Ratio	0.56	0.52	0.62	0.53	0.20	0.28

Intersection Summary

m Volume for 95th percentile queue is metered by upstream signal.



Lane Group	EBT	EBR	NBT	SBL	SBT
Lane Group Flow (vph)	471	440	1071	25	536
v/c Ratio	0.93	0.69	0.62	0.15	0.29
Control Delay	45.7	12.7	14.1	31.7	3.8
Queue Delay	0.0	0.0	0.0	0.0	0.0
Total Delay	45.7	12.7	14.1	31.7	3.8
Queue Length 50th (ft)	144	42	111	9	36
Queue Length 95th (ft)	#313	132	#284	m16	1
Internal Link Dist (ft)	984		364		287
Turn Bay Length (ft)					
Base Capacity (vph)	526	654	1721	288	1876
Starvation Cap Reductn	0	0	0	0	0
Spillback Cap Reductn	0	0	0	0	0
Storage Cap Reductn	0	0	0	0	0
Reduced v/c Ratio	0.90	0.67	0.62	0.09	0.29

Intersection Summary

95th percentile volume exceeds capacity, queue may be longer.

Queue shown is maximum after two cycles.

m Volume for 95th percentile queue is metered by upstream signal.

Aramis Solar Project TIS
 1: Manning Rd & Morgan Territory Rd

08/31/2020

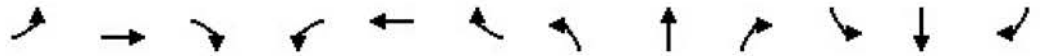

Movement	EBL	EBT	EBR	WBL	WBT	WBR	NBL	NBT	NBR	SBL	SBT	SBR
Lane Configurations		↕			↕			↕			↕	
Traffic Volume (veh/h)	7	209	0	1	81	43	0	0	0	14	0	0
Future Volume (Veh/h)	7	209	0	1	81	43	0	0	0	14	0	0
Sign Control		Free			Free			Stop			Stop	
Grade		0%			0%			0%			0%	
Peak Hour Factor	0.85	0.85	0.92	0.92	0.85	0.85	0.92	0.92	0.92	0.85	0.92	0.85
Hourly flow rate (vph)	8	246	0	1	95	51	0	0	0	16	0	0
Pedestrians					1							
Lane Width (ft)					12.0							
Walking Speed (ft/s)					3.5							
Percent Blockage					0							
Right turn flare (veh)												
Median type		None			None							
Median storage (veh)												
Upstream signal (ft)												
pX, platoon unblocked												
vC, conflicting volume	146			246			384	410	247	386	384	120
vC1, stage 1 conf vol												
vC2, stage 2 conf vol												
vCu, unblocked vol	146			246			384	410	247	386	384	120
tC, single (s)	4.1			4.1			7.1	6.5	6.2	7.1	6.5	6.2
tC, 2 stage (s)												
tF (s)	2.2			2.2			3.5	4.0	3.3	3.5	4.0	3.3
p0 queue free %	99			100			100	100	100	97	100	100
cM capacity (veh/h)	1436			1320			571	528	791	570	546	931
Direction, Lane #	EB 1	WB 1	NB 1	SB 1								
Volume Total	254	147	0	16								
Volume Left	8	1	0	16								
Volume Right	0	51	0	0								
cSH	1436	1320	1700	570								
Volume to Capacity	0.01	0.00	0.00	0.03								
Queue Length 95th (ft)	0	0	0	2								
Control Delay (s)	0.3	0.1	0.0	11.5								
Lane LOS	A	A	A	B								
Approach Delay (s)	0.3	0.1	0.0	11.5								
Approach LOS			A	B								
Intersection Summary												
Average Delay			0.6									
Intersection Capacity Utilization			25.6%		ICU Level of Service				A			
Analysis Period (min)			15									

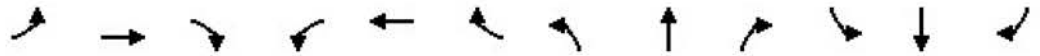

Movement	EBL	EBT	EBR	WBL	WBT	WBR	NBL	NBT	NBR	SBL	SBT	SBR
Lane Configurations				↖	↔		↖↗	↑			↕↕	↗
Traffic Volume (vph)	0	0	0	303	3	29	625	511	0	0	171	290
Future Volume (vph)	0	0	0	303	3	29	625	511	0	0	171	290
Ideal Flow (vphpl)	1900	1900	1900	1900	1900	1900	1900	1900	1900	1900	1900	1900
Total Lost time (s)				4.7	4.7		4.2	6.2			6.2	6.2
Lane Util. Factor				0.95	0.95		0.97	1.00			0.95	1.00
Fr _t				1.00	0.97		1.00	1.00			1.00	0.85
Fl _t Protected				0.95	0.96		0.95	1.00			1.00	1.00
Satd. Flow (prot)				1681	1656		3433	1863			3539	1583
Fl _t Permitted				0.95	0.96		0.95	1.00			1.00	1.00
Satd. Flow (perm)				1681	1656		3433	1863			3539	1583
Peak-hour factor, PHF	0.96	0.96	0.96	0.96	0.96	0.96	0.96	0.96	0.96	0.96	0.96	0.96
Adj. Flow (vph)	0	0	0	316	3	30	651	532	0	0	178	302
RTOR Reduction (vph)	0	0	0	0	13	0	0	0	0	0	0	200
Lane Group Flow (vph)	0	0	0	177	159	0	651	532	0	0	178	102
Turn Type				Perm	NA		Prot	NA			NA	Perm
Protected Phases					8		5	2			6	
Permitted Phases				8								6
Actuated Green, G (s)				11.2	11.2		16.7	42.9			22.0	22.0
Effective Green, g (s)				11.2	11.2		16.7	42.9			22.0	22.0
Actuated g/C Ratio				0.17	0.17		0.26	0.66			0.34	0.34
Clearance Time (s)				4.7	4.7		4.2	6.2			6.2	6.2
Vehicle Extension (s)				2.0	2.0		2.0	2.5			2.5	2.5
Lane Grp Cap (vph)				289	285		882	1229			1197	535
v/s Ratio Prot							c0.19	c0.29			0.05	
v/s Ratio Perm				c0.11	0.10							0.06
v/c Ratio				0.61	0.56		0.74	0.43			0.15	0.19
Uniform Delay, d ₁				24.9	24.6		22.1	5.3			15.0	15.2
Progression Factor				1.00	1.00		1.32	0.72			1.00	1.00
Incremental Delay, d ₂				2.7	1.3		1.1	0.4			0.3	0.8
Delay (s)				27.6	26.0		30.2	4.2			15.2	16.0
Level of Service				C	C		C	A			B	B
Approach Delay (s)		0.0			26.8			18.5			15.7	
Approach LOS		A			C			B			B	

Intersection Summary			
HCM 2000 Control Delay	19.3	HCM 2000 Level of Service	B
HCM 2000 Volume to Capacity ratio	0.60		
Actuated Cycle Length (s)	65.0	Sum of lost time (s)	15.1
Intersection Capacity Utilization	101.0%	ICU Level of Service	G
Analysis Period (min)	15		

c Critical Lane Group

APPENDIX F – DETAILED PROJECT-GENERATED VEHICLE MILES TRAVELED (VMT) CALCULATIONS

Aramis Renewable Energy Project - VMT Calculations

Project-Generated VMT by Construction Phase

Construction Phase	Duration (Business Days)	Trip Type	Daily Trips	Daily Oakland VMT	Daily San Leandro VMT	Daily Hayward VMT	Daily Fremont VMT	Daily Tracy VMT	Daily Port of Oakland VMT	Total Daily VMT	Per Capita VMT ¹
(1) Site Prep	30	Worker (Home/Site)	200	2665	589	967	890	656	-	5767	67
		Worker (Lunch Break)	200	387	106	182	110	138	-	923	
		Haul Truck	46	-	-	-	-	-	1569	1569	68
		Total	446	3052	695	1149	1000	794	1569	8259	-
(2) PV Installation	150	Worker (Home/Site)	500	6661	1472	2416	2223	1638	-	14410	67
		Worker (Lunch Break)	500	967	264	454	273	344	-	2302	
		Haul Truck	52	-	-	-	-	-	1774	1774	68
		Total	1052	7628	1736	2870	2496	1982	1774	18486	-
(3) Electric+Gen-tie	75	Worker (Home/Site)	250	3331	736	1208	1112	819	-	7206	67
		Worker (Lunch Break)	250	484	132	227	137	172	-	1152	
		Haul Truck	10	-	-	-	-	-	341	341	68
		Total	510	3815	868	1435	1249	991	341	8699	-
(4) Vehicles - Equipment	175	Worker (Home/Site)	-	-	-	-	-	-	-	-	-
		Worker (Lunch Break)	-	-	-	-	-	-	-	-	
		Haul Truck	59	-	-	-	-	-	2012	2012	68
		Total	59	-	-	-	-	-	2012	2012	-
Total			14495	3299	5454	4745	3767	3684	35444		

Peak Construction Period VMT (Overlap of Phases 2, 3, and 4)

Trip Type	Total Daily VMT	Daily per Capita VMT
Worker (Home/Site)	21,616	57.6
Worker (Lunch Break)	3,454	9.2
Worker (Combined)	25,070	66.9
Haul Truck	4,127	68.2

Notes

1. Per capita VMT for workers reflects combined VMT for home/site trips and off-site lunch-break trips

Trip Distribution and Trip Length by Origin/Destination

City	Worker Population by Industry	Distance from Project Site
Oakland ¹	42%	31.7
San Leandro ²	11%	25.7
Hayward ³	20%	24.5
Fremont ⁴	12%	37.5
Tracy ⁵	15%	21.9
Livermore ⁶	-	4.6
Port of Oakland ⁷	-	34.1
Total	100%	-

Notes

1. Assumes approximate City centroid at intersection of Fruitvale Ave & MacArthur Blvd

2. Assumes approximate City centroid at intersection of Alvarado St & Marina Blvd

3. Assumes approximate City centroid at intersection of W Harder Rd & Gading Rd

4. Assumes approximate City centroid at intersection of Fremont Blvd & Mowry Ave

5. Assumes approximate City centroid at intersection of Tracy Blvd & W 11th St

6. Half of all worker trips are assumed to be lunch-break trips off site to a commercial/restaurant center location. This analysis uses Livermore's Arcade Shopping Center, approximately 4.6 miles south of the Project site.

7. All haul trips assumed to travel to and from the Port of Oakland



Consulting Group

170 Maiden Lane, Fifth Floor
San Francisco, CA 94108
(415) 392-9688

1617 Clay Street
Oakland, CA 94612
(510) 272-9597

2150 Trade Zone Boulevard, Suite 105A
San Jose, CA 95131
(408) 477-2181

801 South Grand Avenue, 11th Floor
Los Angeles, CA 90017
(602) 885-7481

www.chsconsulting.net
