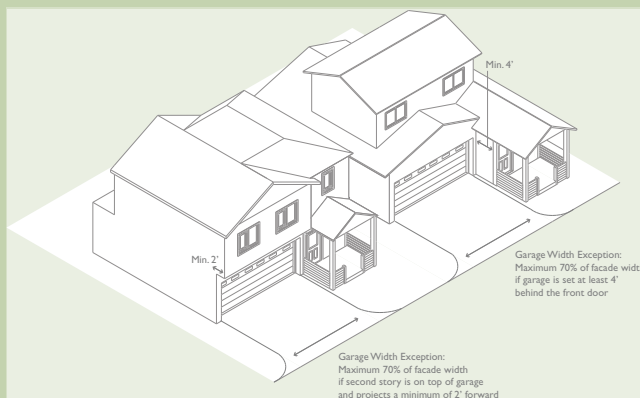
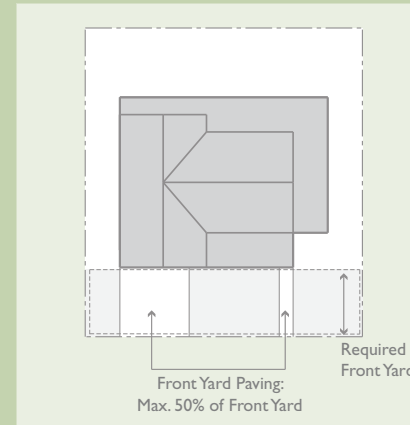




2014

# Residential Design Standards and Guidelines

For the Unincorporated Communities of West Alameda County



## **ALAMEDA COUNTY BOARD OF SUPERVISORS**

Scott Haggerty  
Richard Valle  
Wilma Chan  
Nate Miley  
Keith Carson

## **ALAMEDA COUNTY PLANNING COMMISSION**

Michael Jacob  
Frank Imhof  
Alane Loisel  
Jeff Moore  
Larry Ratto  
Kathie Ready  
Richard Rhodes

## **DESIGN GUIDELINES TASK FORCE**

Ruth Baratta  
Susan Beck  
Howard Beckman  
Hafsa Burt  
Marc Crawford  
Kathy Gil  
Kathy Ready  
Stan Stadelman  
Charles Snipes

In memory of Darlene Emmel, member of the Fairview community

## **ALAMEDA COUNTY STAFF**

COMMUNITY DEVELOPMENT AGENCY  
Chris Bazar, *Agency Director*  
Albert Lopez, *Planning Director*  
Sandra Rivera, *Assistant Planning Director*  
Rodrigo Orduña, *AICP, Senior Planner*  
Howard Lee, *Planner III*

## **CONSULTANT TEAM**

**DYETT & BHATIA**  
Urban and Regional Planners

### LEAD CONSULTANTS

Leslie Gould, *Principal*  
Melinda Hue, *Planner*  
Diana Nankin, *Senior Graphic Designer*



Vivian Kahn, *FAICP, Principal*

# Alameda County Residential Design Standards and Guidelines

## TABLE OF CONTENTS

---

<b>1.</b>	<b>INTRODUCTION.....</b>	<b>1-1</b>
1.1	Background and Process.....	1-3
1.2	Purpose and Application.....	1-4
1.3	Relationship to the Zoning Code, General Plans and Specific Plans .....	1-6
1.4	Organization of the Design Standards and Guidelines Document.....	1-8
<b>2.</b>	<b>DEVELOPMENT STANDARDS FOR RESIDENTIAL PROJECTS.....</b>	<b>2-1</b>
2.1	Residential Building Types: Appropriate Zones and Densities .....	2-3
2.2	Single-Family Structures, Subdivisions and Hillside Development Standards .....	2-7
2.3	Small-Lot Single-Family Home Standards.....	2-25
2.4	Townhome Standards.....	2-39
2.5	Multi-Family Residential Standards .....	2-55
<b>3.</b>	<b>DESIGN GUIDELINES FOR RESIDENTIAL PROJECTS.....</b>	<b>3-1</b>
A.	Development Intensity and Neighborhood Compatibility .....	3-3
B.	Building Height and Form .....	3-4

C.	Building Relationship to the Street .....	3-7
D.	Building Design.....	3-9
E.	Building Setbacks for Light, Air, and Privacy .....	3-16
F.	Auto Circulation: Site Access, Streets, and Driveways.....	3-17
G.	Parking Location and Design.....	3-18
H.	Facilities for Walking, Bicycle, Transit.....	3-20
I.	Site Landscaping .....	3-22
J.	Usable Open Space.....	3-25
K.	Fences and Walls.....	3-27
L.	Services.....	3-28
<b>4.</b>	<b>DEVELOPMENT STANDARDS FOR RESIDENTIAL MIXED-USE PROJECTS.....</b>	<b>4-1</b>
4.1	Residential Mixed Use: Appropriate Zones and Densities.....	4-3
4.2	Residential Mixed-Use Standards .....	4-5
<b>5.</b>	<b>DESIGN GUIDELINES FOR RESIDENTIAL MIXED-USE PROJECTS.....</b>	<b>5-1</b>
A.	Development Intensity .....	5-3
B.	Location of Commercial and Residential Uses.....	5-4
C.	Building Height and Form.....	5-5
D.	Building Relationship to the Street .....	5-7
E.	Building Design.....	5-10

- F. Building Setbacks for Light, Air, and Privacy ..... 5-16
- G. Auto Circulation: Site Access and Driveways ..... 5-17
- H. Parking Location and Design..... 5-18
- I. Facilities for Pedestrians, Bicycles and Transit ..... 5-19
- J. Site Landscaping ..... 5-21
- K. Usable Open Space..... 5-24
- L. Fences and Walls..... 5-26
- M. Services..... 5-27

**6. STANDARDS THAT APPLY TO ALL OR SOME PROJECTS.....6-1**

- Parking ..... 6-2
- Bicycle Parking ..... 6-3
- Projections into Required Yards ..... 6-4
- Fences and Walls ..... 6-5
- Trash Enclosures ..... 6-7
- Parking Area Landscaping ..... 6-7

**7. DEFINITIONS AND RULES OF MEASUREMENT.....7-1**

- Definitions ..... 7-2
- Rules of Measurement..... 7-4
- Policies..... 7-5

## FIGURES

Figure 2.2-1:	Single-Family Residential R-1: Summary of Major Development Standards.....	2-8
Figure 2.2-2:	Single-Family Residential: Height .....	2-9
Figure 2.2-3:	Single-Family Residential: Front Yard Paving .....	2-9
Figure 2.2-4:	Single-Family Residential: Front Porch or Covered Recess.....	2-10
Figure 2.2-5:	Single-Family Residential: First Story Lot Rear Setback Exception .....	2-11
Figure 2.2-6:	Single-Family Residential: Flag Lot .....	2-12
Figure 2.2-7:	Single-Family Residential R-1 Hillside: Summary of Additional Major Development Standards .....	2-18
Figure 2.2-8:	Single-Family Residential Hillside: Height.....	2-19
Figure 2.2-9:	Single-Family Residential Hillside: Retaining Wall Height.....	2-20
Figure 2.3-1:	Small-Lot Single-Family Homes: Summary of Major Development Standards.....	2-26
Figure 2.3-2:	Small-Lot Single-Family Homes: Narrow Lot (60' to 75' Wide): Summary of Major Development Standards .....	2-27
Figure 2.3-3:	Small-Lot Single-Family Homes: Narrow Lot (Lots < 60' Wide, Maximum Two Units): Summary of Major Development Standards .....	2-28
Figure 2.3-4:	Small-Lot Single-Family: Height.....	2-29
Figure 2.3-5:	Small-Lot Single-Family: Front Yard Paving and Gates .....	2-30
Figure 2.3-6:	Small-Lot Single-Family: Front Porch or Covered Recess .....	2-30
Figure 2.3-7:	Small-Lot Single-Family: Interior Elevation.....	2-31

Figure 2.3-8: Small-Lot Single-Family: Garage Aprons..... 2-31

Figure 2.3-9: Small-Lot Single-Family: Garage Exception..... 2-32

Figure 2.3-10: Small-Lot Single-Family: Side Setbacks ..... 2-33

Figure 2.3-11: Small-Lot Single-Family: Minimum Distance Between Buildings ..... 2-34

Figure 2.4-1: Two-Story Townhomes: Summary of Major Development Standards..... 2-40

Figure 2.4-2: Townhomes on Narrow Lots: Summary of Major Development Standards..... 2-41

Figure 2.4-3: Three-Story Townhomes: Summary of Major Development Standards ..... 2-42

Figure 2.4-4: Townhomes: Height ..... 2-43

Figure 2.4-5: Townhomes: Garage Width ..... 2-44

Figure 2.4-6: Townhomes: Garage Width Exception ..... 2-44

Figure 2.4-7: Townhome: Garage Width Exception for Three Stories ..... 2-45

Figure 2.4-8: Townhomes: Side Yards ..... 2-46

Figure 2.4-9: Townhomes: Open Space ..... 2-47

Figure 2.4-10: Townhomes: Front Yard Paving and Gates..... 2-47

Figure 2.4-11: Townhomes: Front Porch or Covered Recess..... 2-47

Figure 2.4-12: Townhomes: Driveway Aprons ..... 2-47

Figure 2.5-1: Multi-Family Residential: Summary of Major Development Standards ..... 2-56

Figure 2.5-2: Multi-Family Residential Project ..... 2-57

Figure 2.5-3: Multi-Family Residential: Elevation ..... 2-58

Figure 2.5-4: Multi-Family Residential: Front Yard Paving .....2-58

Figure 2.5-5: Multi-Family Residential: Side and Rear Setbacks ..... 2-59

Figure 2.5-6: Multi-Family Residential: Primary Entrance .....2-60

Figure 2.5-7: Multi-Family Residential: Open Space.....2-60

Figure 2.5-8: Multi-Family Residential: Front Setback and Elevation above Sidewalk..... 2-61

Figure 2.5-9: Multi-Family Residential: Height Projections..... 2-61

Figure 2.5-10: Multi-Family Residential: Ground Floor Articulation ..... 2-61

Figure 4.2-1: Residential Mixed Use: Summary of Major Development Standards .....4-6

Figure 4.2-2: Residential Mixed Use: Street Elevation ..... 4-7

Figure 4.2-3: Residential Mixed Use: Setbacks for Primary Windows .....4-8

Figure 4.2-4: Residential Mixed Use: Frontages ..... 4-9

Figure 4.2-5: Residential Mixed Use: Commercial Elevation Above Sidewalk ..... 4-9

Figure 4.2-6: Residential Mixed Use: Front Setback ..... 4-10

Figure 4.2-7: Residential Mixed-Use Front Setback Adjacent to Residential ..... 4-10

Figure 4.2-8: Residential Mixed Use: Open Space..... 4-11

Figure 4.2-9: Residential Mixed Use: Ground Floor Wall Plane Articulation ..... 4-11

Figure 4.2-10: Residential Mixed Use: Side and Rear Setbacks ..... 4-12

Figure 4.2-11: Residential Mixed Use: Height Projections and Façade ..... 4-13

Figure 6-1: Parking ..... 6-2



Figure 6-2:	Bicycle parking .....	6-3
Figure 6-3:	Projections.....	6-4
Figure 6-4:	Fences .....	6-5
Figure 6-5:	Fence Heights .....	6-6
Figure 6-6:	Landscaped Islands.....	6-8
Figure 6-7:	Additional Specific Plan Requirements .....	6-9

**TABLES**

Table 2.1-1:	Residential Maximum Densities and Appropriate Zones.....	2-4
Table 2.2-1:	Single-Family Subdivision Standards .....	2-13
Table 2.2-2:	Additional Regulations for Hillside Lots.....	2-21
Table 2.3-1:	Small-Lot Single-Family Homes .....	2-35
Table 2.4-1:	Townhome Standards .....	2-49
Table 2.5-1:	Multi-Family Residential Standards .....	2-63
Table 4.1-1:	Residential Mixed-Use Maximum Densities and Appropriate Zones .....	4-4
Table 4.2-1:	Residential Mixed-Use Standards .....	4-15
Table 6.1:	Standard Parking Space and Aisle Dimensions .....	6-2

*Page Intentionally Left Blank*

**1**

# **INTRODUCTION**

This Chapter presents an introduction to the Design Standards and Guidelines document and provides guidance regarding the application of the Design Standards and Guidelines. This Chapter is organized by the following sections:

1.1 Background and Process

1.2 Purpose and Application

1.3 Relationship to the Zoning Code, General Plans and Specific Plans

1.4 Organization of the Design Standards and Guidelines Document

# 1.1 Background and Process

## Background

The Alameda County Board of Supervisors decided to prepare Design Standards and Guidelines for the unincorporated communities of West Alameda County to address neighborhood concerns about the quality of development in these communities.

In the past, a number of developments have used Planned Development zoning to achieve greater density without providing the commensurate amenities and high quality design. Specific problems identified by the community and Staff included, but were not limited to:

- Bulkiness of past developments, especially on small-lots;
- Concern regarding overall appearance of projects including lack of architectural character and blank street-facing facades;
- Insufficient landscaping and open space;
- Parking and circulation issues, including dominance of garage doors and access driveways, creating an unfriendly pedestrian space on the public street, and insufficient guest parking;
- Lack of clarity and detail regarding design expectations.

The Board of Supervisors have requested a set of standards and guidelines be prepared to provide greater detail about design expectations for residential projects, and provide greater consistency in the review of projects by County staff.

## Planning Process

The Board appointed a Design Standards and Guidelines Task Force, whose members included architects, developers, and community residents from the unincorporated areas of West Alameda County, to help guide the planning process. Planning consultants were hired to work with the Task Force and County Planning Department staff.

The planning process involved an analysis of existing regulations and standards contained in the County's Zoning Ordinance and Specific Plans, a review of Design Standards and Guidelines from comparable communities, interviews with County Staff and community stakeholders, and a field tour of existing residential projects in the unincorporated West Alameda County areas.

Existing residential projects were further evaluated through the review of development project applications and site visits to the project sites. Reports were prepared for different residential building types that summarized the analysis of existing development in unincorporated West Alameda County and recommended additional

standards and guidelines. The types of development analyzed included: townhomes, small-lot single-family homes, single-family subdivisions, hillside development, multi-family and residential mixed-use development.

A series of study sessions were held with the Task Force to discuss the analysis and recommendations for each different building type, to provide an opportunity for public input, and to review the Draft Design Standards and Guidelines. Public hearings were held with community boards, the Planning Commission, and Board of Supervisors. The final residential development standards and guidelines were adopted October 2014.

# 1.2 Purpose and Application

## Purpose

The purpose of the Design Standards and Guidelines is to provide greater certainty about project design standards and expectations for both project applicants and community residents. The goal is to expedite the review process by clearly stating the County's desires for high-quality residential projects that contribute to the long-term value of the neighborhood and provide livable units for residents.

## Applicability to Geographic areas of Unincorporated West Alameda County

The Design Standards and Guidelines are applicable to the unincorporated areas of western Alameda County within the Castro Valley General Plan and the Eden Area General Plan, including the five planning areas of Ashland, Castro Valley, Cherryland, Fairview, and San Lorenzo. Within Castro Valley, these Design Standards and Guidelines are applicable within the Castro Valley Urbanized Area.

## Application of the Design Standards and Guidelines

The Design Standards establish the County regulatory framework for the design of residential projects in the unincorporated communities of West Alameda County. They provide a location for updated development standards.

The Design Guidelines serve the following functions:

- A guide for the preparation of project proposals by property owners, developers, and architects;
- A guide for the review of projects by County Staff; and
- A guide for County decision-makers in reviewing and deciding project applications;
- A location for updated development standards.

### Guiding Principles

The Design Standards and Guidelines are based on the following guiding principles:

#### Guiding Principle 1-1:

Design residential development projects are to comply with all of these Standards and the intent of the Guidelines. In the event of

a conflict between the existing development standards in the Zoning Code and these Standards and Guidelines, these Standards and Guidelines shall apply.

#### Guiding Principle 1-2:

The Design Standards and Guidelines shall be subject to the enforceability of the various Specific Plans for unincorporated West Alameda County as stated in this document.

#### Guiding Principle 1-3:

Zoning designations shall establish the maximum density allowed on individual properties. If an applicant is requesting a greater number of units than allowed under existing zoning, the applicant is not entitled to rezone the property to another existing zoning category, unless the change conforms to all of the policies in the General Plan.

#### Guiding Principle 1-4:

Planned Development zoning cannot be used to increase density above that which is allowed by the General Plan.

#### Guiding Principle 1-5:

Exceptions to design standards and guidelines will only be considered through a discretionary review process, and only approved if:

#### Guiding Principle 1-5a:

There are site-specific conditions that make it physically infeasible to follow the standards or guidelines;

and

#### Guiding Principle 1-5b:

The proposed design provides an equal or better design solution in terms of livability for residents and impacts on neighboring properties.

#### Guiding Principle 1-6:

A development project is not entitled to the maximum density allowed under zoning if the project cannot comply with the design standards. On many small and/or narrow lots in the County, the potential density may be lower than the maximum allowed under zoning. A narrow lot is not a basis for approving exceptions to development standards.

### Standards

Standards are qualitative or quantifiable rules or measures that must be satisfied. The standards in this document are intended to supplement and update existing development standards in the County Zoning Ordinance. These standards specify residential building types appropriate in each zoning district, and establish a detailed set of project review criteria. The Board of Supervisors will incorporate these development standards into the County Zoning Ordinance. Once adopted, these development standards will serve as the basis for project review. Exceptions to these standards require either a variance or conditional use permit, as regulated in the County Zoning Ordinance.

### Guidelines

Guidelines express objectives with respect to specific development features or conditions and explain why a particular guideline or criterion is an appropriate way to achieve the objective. Guidelines provide graphic examples and verbal description showing approaches that conform to the guidelines. These guidelines augment the standards in this document and provide qualitative direction on how to meet the County's goal for high quality design of residential projects. Any deviation from the intent of these guidelines or the letter of these standards is a deviation from the Zoning Ordinance and requires approval of a Variance. However, use variances are never allowed.

### Diagrams and Photos

Diagrams and photographs shown here are intended to illustrate a certain standard or intended to represent particular aspects of design. Most of the photographs

shown here will have an accompanying caption, which will state what particular design feature the photograph is intended to illustrate.

Some photographs of developments may show site planning or architectural features that do not comply with the Design Standards and Guidelines, and therefore are not encouraged. The inclusion of a photograph of a certain development project does not mean that a subsequent similar project will meet the Design Standards and Guidelines, nor does it mean that the development project shown in the photograph is an overall exemplary project.

Applicants should meet with County staff early in the design process for assistance with the interpretation of the Design Guidelines and their application to a specific site or project.

# 1.3 Relationship to the Zoning Code, General Plans and Specific Plans

## Zoning Code

The Design Standards and Guidelines have been carefully crafted to be consistent with the densities of each zoning district. It is important to note that the majority of residentially zoned properties in the Alameda County unincorporated communities are small and/or very narrow and deep. The lot pattern stems from the historical development pattern of agricultural lots.

Analysis shows that on the small and narrow lots, it is not necessarily possible to achieve the maximum density allowed under zoning. The size and shape of these lots is not efficient for development. Potential densities can be 15-25% less than the maximum allowed density, due to the inefficiency of narrow lots. As stated in the policies, property owners are not entitled to the maximum density if they cannot comply with the development standards and guidelines. Merging narrow lots may be required in order to develop to the maximum allowed density and comply with the development standards and guidelines.

These development standards supersede development standards for residential and residential/commercial mixed-use development in the Zoning Ordinance.

These design guidelines are intended to complement these development standards. The intent of these design guidelines shall be met unless it can be demonstrated to the satisfaction of the decision-making body for the development project that meeting the intent of the design guidelines is physically infeasible or detrimental to the environmental quality of the project or surrounding area. While the intent of these design guidelines shall be met unless as otherwise noted, each individual design measure may be implemented, subject to the discretion of the decision-making body for the development project. Where these Design Standards and Guidelines are silent or perceived to be silent, the Zoning Ordinance shall govern.

## General Plans

One General Plan exists for both the Castro Valley Area and the Eden Area, covering the urbanized unincorporated communities of the County. The General Plan establishes land use designations, densities, and a wide variety of other policies related to future development. Where there is any conflict between these Residential Design Standards and Guidelines and the Castro Valley Area General Plan and the Eden Area General Plan, the General Plan governs. These

Design Standards and Guidelines have been prepared to be consistent with the policy direction of the recently adopted Eden Area and Castro Valley Area General Plans.

## Specific Plans

The following Specific Plans have been prepared for certain urbanized areas of the County. These provide much greater detail about land use, development standards, building design, and street improvements than exist in the General Plan, and serve as the zoning for the area. Each plan is listed, and its relationship to the Design Standards and Guidelines is described.

### Ashland and Cherryland Business Districts (ACBD) and Castro Valley Central Business District (CVCBD) Specific Plans

The ACBD and CVCBD allows multi-family residential projects and mixed-use development projects in certain zones. Special provisions in the ACBD and CVCBD Plans have been incorporated into the Design Standards and Guidelines. The Design Standards and Guidelines shall be the primary guiding document for review of multi-family and mixed-use projects in the



ACBD and CVCBD as they provide more detail than the Specific Plans, as well as provide guidance about the review criteria for exceptions.

Policies and guidelines not included in this document, but are contained in the Specific Plans (such as, but not limited to signs, graphics, and awnings and public improvements), shall continue to apply. The Design Standards and Guidelines may be updated from time to time as the Specific Plans are updated.

### Fairview and Madison Area Specific Plans

The Fairview and Madison Area Specific Plans establish a special set of development standards tailored to the single-family hillside development in those areas of the County. The Fairview and Madison Area Specific Plans remain the governing documents for development in the Fairview and Madison areas. The Fairview and Madison Area Specific Plans set the basic development standards such as density and setbacks, which are summarized in these Design Standards and Guidelines. These Design Standards and Guidelines provide additional guidance relative to height measurement, building design, and other focused topics. Where there is any contradiction between those specific plans and these Design Standards and Guidelines, those specific plans shall govern. Where those specific plans are silent or perceived to be silent, these Design Standards and Guidelines shall govern.

### San Lorenzo Village Center Specific Plan

The San Lorenzo Village Center Specific Plan contains detailed parcel-specific design recommendations for this small village center area. The San Lorenzo Village Specific Plan remains the governing document for development in San Lorenzo Village Center.

### Specific Plans Not Listed Herein

The Design Standards and Guidelines shall be applicable to all relevant current and future specific plans within the County, unless otherwise stated in this document or in the specific plans, and may be updated from time to time as the Specific Plans are updated.

# 1.4 Organization of the Design Standards and Guidelines Document

## Residential Projects

### Standards

#### Chapter 2

Chapter 2 presents the standards for residential development projects. Section 2.1 describes the residential zoning districts, densities, and discusses the building types appropriate for each zoning district.

Sections 2.2 through 2.5 contain the development standards for each residential building type. These sections contain diagrams illustrating the major development standards and are followed by development standard tables.

### Guidelines

#### Chapter 3

Chapter 3 establishes basic project design guidelines for residential development projects. The project design guidelines are organized by topic, corresponding to the organization of the Design Standards in Chapter 2. Each topic contains an explanation of the overall purpose of the guidelines and provides qualitative direction about how to meet the County's goals for residential projects.

## Residential Mixed-Use Projects

### Standards

#### Chapter 4

Chapter 4 presents the development standards for residential mixed-use projects. Section 4.1 describes the mixed-use Specific Plan districts and densities.

Section 4.2 contains the development standards for residential mixed-use projects and contains diagrams illustrating the major development standards, followed by the development standards table.

### Guidelines

#### Chapter 5

Chapter 5 establishes basic project design guidelines for residential mixed-use projects. The project design guidelines are organized by topic, corresponding to the organization of the Design Standards in Chapter 4. Each topic contains an explanation of the overall purpose of the guidelines and provides qualitative direction about how to meet the County's goals for residential mixed-use projects.

## Standards That Apply to All or Some Projects

### Standards

#### Chapter 6

Chapter 6 presents development standards that apply to all or some development projects with residential uses, such as parking dimensions, projections, and fence heights.

## Definitions and Rules of Measurement

### Chapter 7

Chapter 7 presents definitions and rules of measurement.

# 2

# DEVELOPMENT STANDARDS FOR RESIDENTIAL PROJECTS

This Chapter presents the development standards for residential projects. Section 2.1 discusses the types of residential buildings appropriate within various zoning districts in the unincorporated areas of West Alameda County. In Sections 2.2 to 2.5, drawings are shown first to provide a summary of the major development standards in a visual format. Then a table listing all development standards follows. Standards that are in bold italics are existing County Zoning standards. This Chapter is organized by the following sections:

### 2.1 Residential Building Types: Appropriate Zones and Densities

### 2.2 Single-Family Subdivision and Hillside Standards

### 2.3 Small-Lot Single Family Home Standards

### 2.4 Townhome Standards

### 2.5 Multi-Family Residential Standards

# 2.1 Residential Building Types: Appropriate Zones and Densities

## Appropriate Zones and Densities

To ensure compatibility between new development and an existing neighborhood, new development should have densities that are appropriate to the building type and the existing density of the surrounding neighborhood.

**Policy 2-1:** Design projects consistent with the following table, which shows the appropriate density ranges for each building type and the zones that are appropriate for each building type. The table may be updated from time to time as new zoning districts are established.

The minimum building site per dwelling unit establishes the minimum developable lot area required for one dwelling unit. When calculating net density for single-family subdivisions, small-lot single family homes and townhomes, the following portions of the property are excluded from the calculation: private streets, access easements, stems, driveways that serve more than one lot, street parking spaces, and any other unservable or unbuildable portion of the lot. This applies to all single-family subdivisions, small-lot single family homes and townhomes, regardless if they are rental or for sale units. This does not apply to air space subdivisions or multi-family rental flats.

## Density Bonuses

A residential development that includes five or more dwelling units and meets one or more of the following criteria is entitled to a density bonus and one or more incentives under State Government Code Section 65915:

- (A) Ten percent of the total units of a housing development for lower income households, as defined in Section 50079.5 of the State Health and Safety Code.
- (B) Five percent of the total units of a housing development for very low income households, as defined in Section 50105 of the State Health and Safety Code.
- (C) A senior citizen housing development, as defined in Sections 51.3 and 51.12 of the State Civil Code, or mobilehome park that limits residency based on age requirements for housing for older persons pursuant to Section 798.76 or 799.5 of the Civil Code.
- (D) Ten percent of the total dwelling units in a common interest development as defined in Section 1351 of the State Civil Code for persons and families of moderate income, as defined in Section 50093 of the State Health and Safety Code, provided that all units in the development are offered to the public for purchase.

**TABLE 2.1-1: RESIDENTIAL MAXIMUM DENSITIES AND APPROPRIATE ZONES**

ACBD: Ashland and Cherryland Business District Specific Plan / CVCBD: Castro Valley Central Business District Specific Plan				
<b>Building Type</b>	<b>Appropriate Zones</b>	<b>Minimum Building Site (Square Feet) Per Dwelling Unit<sup>1</sup></b>	<b>Maximum Net Density (Dwelling Units/Acre)<sup>2</sup></b>	<b>Notes</b>
<b>SINGLE-FAMILY SUBDIVISION</b>	R-1	5,000	8.7	
	R-1-B Combining	8,000 – 40,000	1.1 – 5	Or as specified in the zoning amendment creating the district.
<b>HILLSIDE DEVELOPMENT</b>	R-1	5,000	8.7	
	R-1-B Combining	8,000 – 40,000	1.1 – 5	Or as specified in the zoning amendment creating the district.
	R-1-Hillside (Castro Valley Draft General Plan)	5,000 – 10,000	4 – 8.7	
	Fairview Specific Plan	5,000 – 1 acre	1.0 – 6.0	Maximum densities per the Fairview Specific Plan.
	Madison Area Specific Plan	5,000 – 40,000	1.1 – 8.7	Maximum densities are set by the Madison Area Specific Plan.
<b>SMALL-LOT SINGLE FAMILY</b>	R-S	5,000	8.7	
	R-S-D35	3,500	12.4	
	R-S-DV	3,500	12.4	With lot width less than 100 feet and lot area less than 20,000 square feet.
				If the width of a project site is less than 60 feet, the maximum number of small-lot single-family units allowed on the site is two and the minimum area per two small-lot single-family residential dwelling units is 7,500 square feet.
<b>TWO-STORY TOWNHOMES</b>	R-S-D35	3,500	12.4	
	R-S-DV	3,500	12.4	With lot width less than 100 feet and lot area less than 20,000 square feet.
	R-S-D3	2,500 – 3,000	14.5	As specified in the zoning amendment creating the district.
	R-S-D25	2,500	17.4	
	R-2	2,500	17.4	

Table 2.1-1: Residential Maximum Densities and Appropriate Zones

ACBD: Ashland and Cherryland Business District Specific Plan / CVCBD: Castro Valley Central Business District Specific Plan					
<b>Building Type</b>	<b>Appropriate Zones</b>	<b>Minimum Building Site (Square Feet) Per Dwelling Unit<sup>1</sup></b>	<b>Maximum Net Density (Dwelling Units/Acre)<sup>2</sup></b>	<b>Notes</b>	
<b>THREE-STORY TOWNHOMES</b>	R-S-D25	2,500	17.4		
	R-2	2,500	17.4		
	R-S-D3	2,000 – 2,500	21.8	As specified in the zoning amendment creating the district.	
	R-S-D20	2,000	21.8		
	R-S-DV	2,000	21.8	With lot width more than and equal to 100 feet and lot area more than or equal to 20,000 square feet.	
	R-3	2,000	21.8		
<b>MULTI-FAMILY RESIDENTIAL MEDIUM DENSITY</b>	R-S-D20	2,000	21.8		
	R-3	2,000	21.8		
	R-S-DV	2,000	21.8	With lot width more than and equal to 100 feet and lot area more than or equal to 20,000 square feet.	
	R-S-D15	1,500	29.0		
	R-S-D3	1,500 – 2,000	21.8 – 29.0	As specified in the zoning amendment creating the district.	
	ACBD-RC (Residential/ Commercial)		15 – 25	Residential uses may be developed without commercial uses.	
	CVCBD Land Use Group D Subareas 4, 5, 6, 7, 11		2,500	17.4	With minimum lot size of 10,000 to 20,000 square feet.
			2,000	21.8	With minimum lot size greater than 20,000 square feet.
	Not allowed along Castro Valley Boulevard in Subareas 5, 6, 7  Subarea 7 Limitations: Allowed along side street frontage depending on factors such as specific use, design, adjacent uses, etc. Not allowed along Redwood.			20 – 40	Allowed where a development is substantially composed of units aimed at the elderly or handicapped, where units are mostly studios or one bedroom units, where the parcel is large enough that higher density development can successfully occur, where surface parking is minimized through parking structures, underground parking, etc, or where development is immediately adjacent to the BART station or intensive commercial development.

Table 2.1-1: Residential Maximum Densities and Appropriate Zones

ACBD: Ashland and Cherryland Business District Specific Plan / CVCBD: Castro Valley Central Business District Specific Plan				
<b>Building Type</b>	<b>Appropriate Zones</b>	<b>Minimum Building Site (Square Feet) Per Dwelling Unit<sup>1</sup></b>	<b>Maximum Net Density (Dwelling Units/Acre)<sup>2</sup></b>	<b>Notes</b>
<b>MULTI-FAMILY RESIDENTIAL HIGH DENSITY</b>	R-4	1,250 – 1,000	34.5 – 43.5	
	CVCBD Land Use Group E Subareas 8, 9 Subarea 9 Limitations: Allowed on parcels west of Redwood Road only.		40 – 60	

Notes:

1. The minimum building site per dwelling unit establishes the minimum developable lot area required for one dwelling unit.
2. When calculating net density for single-family subdivisions, small-lot single family homes and townhomes, the following portions of the property are excluded from the calculation: private streets, access easements, stems, driveways that serve more than one lot, street parking spaces, and any other unservable or unbuildable portion of the lot. This applies to all single-family subdivisions, small-lot single family homes and townhomes, regardless if they are rental or for sale units. This does not apply to air space subdivisions, or to multi-family flats.



## 2.2 Single-Family Structures, Subdivisions, and Hillside Development Standards

This section presents the development standards for single-family home subdivisions, and includes a special section related to hillside development.

The purpose of the single-family subdivision and hillside standards is to preserve single-family neighborhoods and ensure that new development is consistent in scale with existing neighborhoods.

Single-family homes are detached homes on lots that range from 5,000 to 40,000 square feet in the unincorporated areas of West Alameda County.

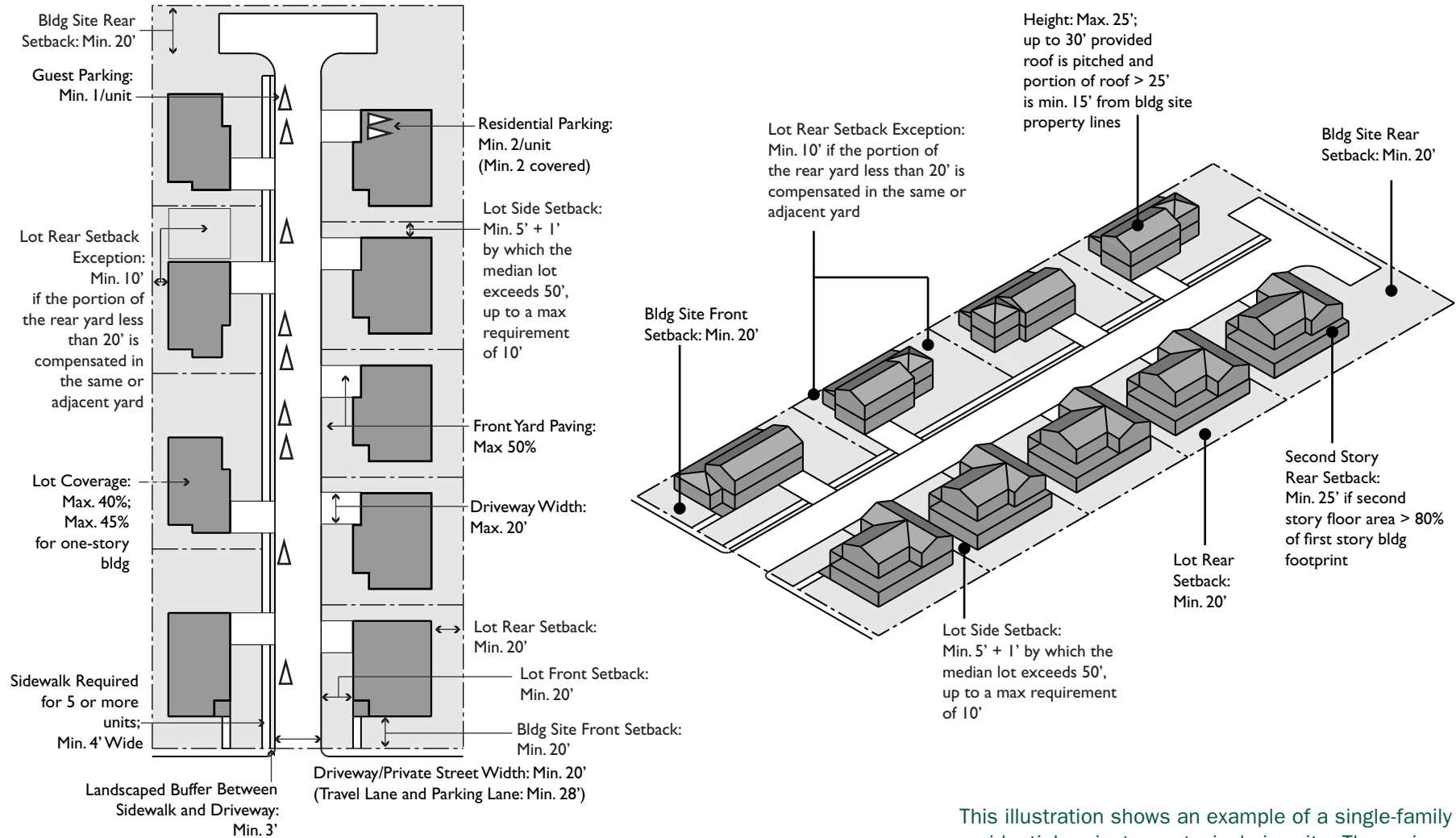
These standards apply in the R-1 Zoning District, where detached single-family homes can be developed. San Lorenzo is predominantly zoned R-1, as are Castro Valley and Fairview.

In Castro Valley and Fairview hillside areas, parcels zoned R-1 may also have a combing B district zoning designation, which modify the site area and yard requirements. In addition, the Fairview area is governed by the Fairview Specific Plan and the Madison area in Castro Valley is governed by the Madison Area Specific Plan.



Figure 2.2-1: Single-Family Residential R-1: Summary of Major Development Standards

NOTE: Diagrams not to be used for density calculations.



This illustration shows an example of a single-family residential project on a typical size site. The major development standards are indicated by text labels. Projects located in State Responsibility Fire Areas may be required to meet additional Fire Department standards.

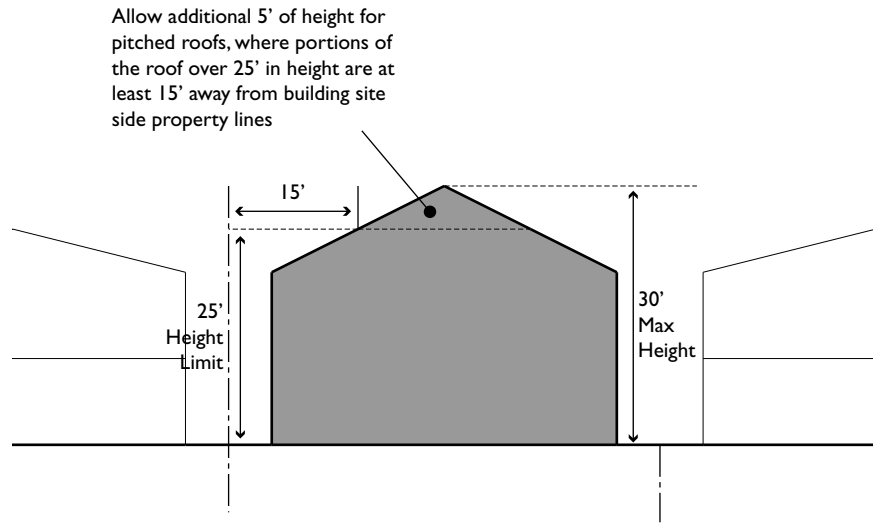
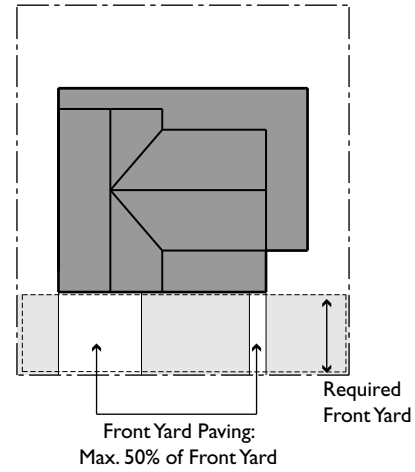


Figure 2.2-2: Single-Family Residential: Front Yard Paving



Projects located in State Responsibility Fire Areas may be required to meet additional Fire Department standards.

Figure 2.2-3: Single-Family Residential: Front Porch or Covered Recess

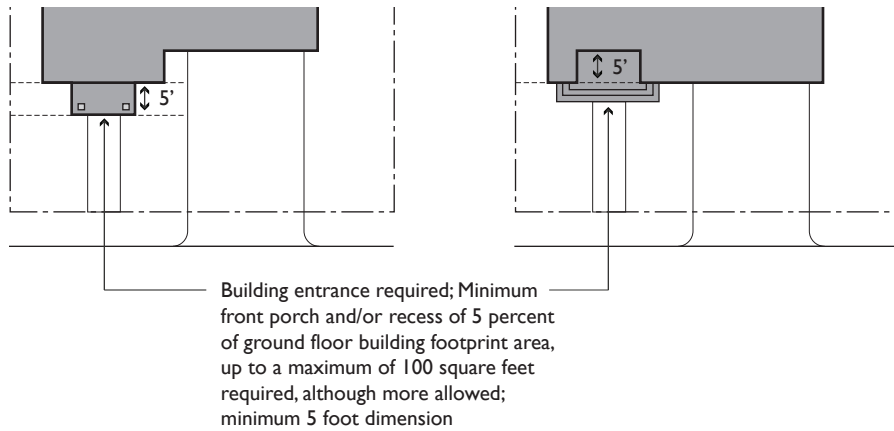


Figure 2.2-4: Single-Family Residential: Garages

For garages with three or more doors, or designed to accommodate three or more non-tandem parked cars see design guidelines section.

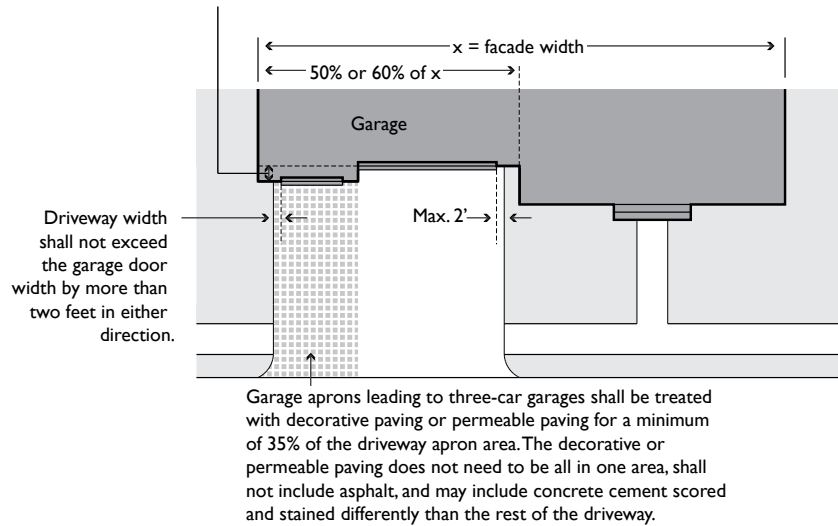
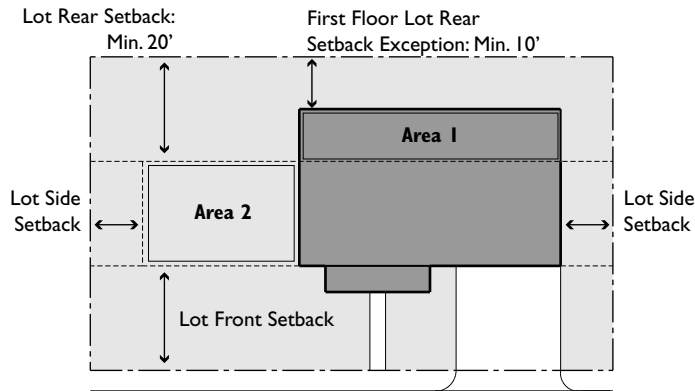


Figure 2.2-5: Single-Family Residential: First Story Lot Rear Setback Exception

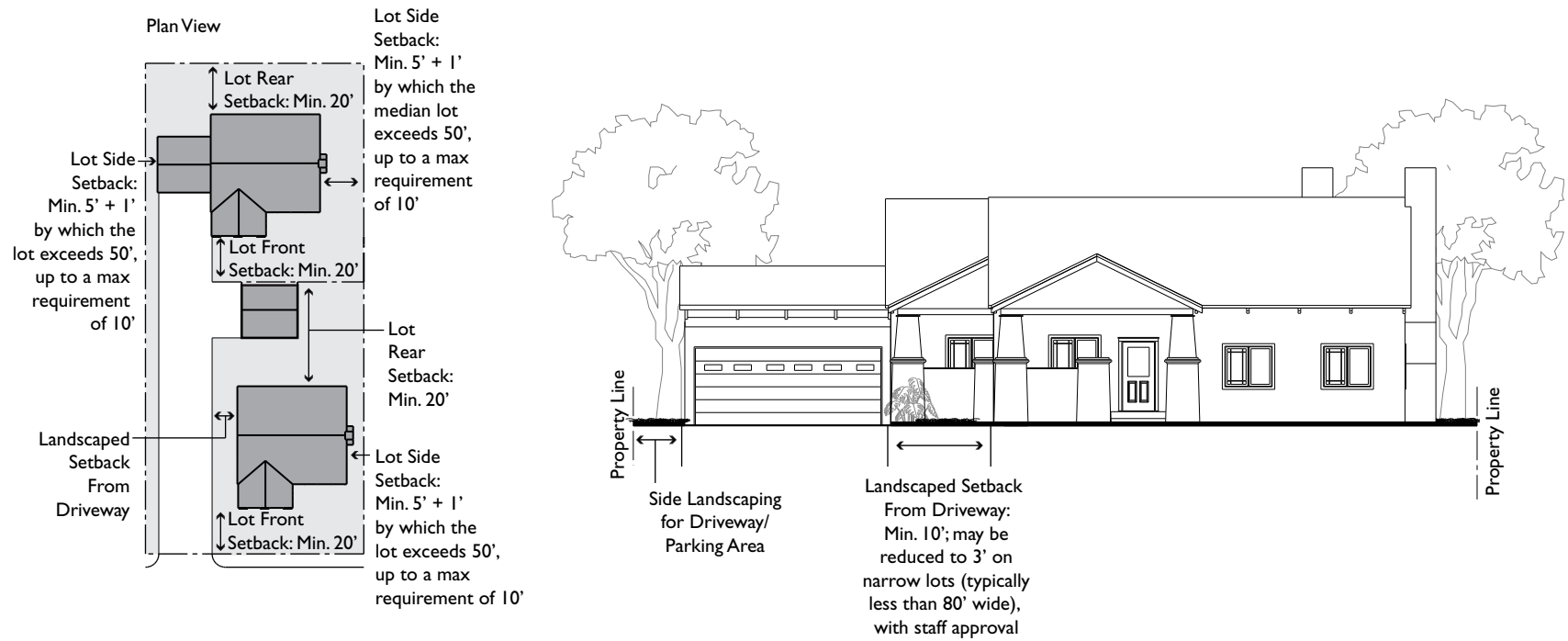


First Story Lot Rear Setback Exception: First Floor Rear setback may be a minimum of 10' if that portion of the rear yard less than 20' in depth (Area I) is compensated by open area within the same or adjacent yards on the same building site that exceed side and rear yard requirements by an area (Area 2) at least equal to extent of building coverage of the 20' rear yard ( $\text{Area 2} \geq \text{Area I}$ ). The minimum dimension of Area 2 is 10'.

Projects located in State Responsibility Fire Areas may be required to meet additional Fire Department standards.

Figure 2.2-6: Single-Family Residential: Flag Lot

NOTE: Diagrams not to be used for density calculations.



**TABLE 2.2-1: SINGLE-FAMILY SUBDIVISION STANDARDS**

<b>Standard<sup>1</sup></b>	<b>R-1</b>	<b>-B-8</b>	<b>-B-10</b>	<b>-B-20</b>	<b>-B-40</b>	<b>Additional Standards</b>
<b>DEVELOPMENT INTENSITY AND NEIGHBORHOOD COMPATIBILITY</b>						
Minimum Building Site and Lot Size (sq ft)	5,000	8,000	10,000	20,000	40,000	In addition, Castro Valley and Fairview require consistency with existing development in the area. See Chapter 7: Lot Size Consistency.
Minimum Lot Width (ft)	50	80	100	150	150	
Minimum Lot Width, Corner Lot (ft)	60					
Maximum Lot Coverage (%)	40	40	40	40	40	
One-Story Building (%)	45	45	45	45	45	
<b>BUILDING HEIGHT AND FORM</b>						
Maximum Height (ft)	25	25	25	25	25	The building height limitation does not apply to chimneys, church spires, flag poles, or to mechanical appurtenances necessary and incidental to the permitted use of a building.
Height Exception (ft)	Up to 30	Up to 30	Up to 30	Up to 30	Up to 30	Provided that the roof is pitched and the portion of the roof over 25 feet in height is at least 15 feet away from building site property lines. See Figure 2.2-2.
Maximum Stories	2	2	2	2	2	
Maximum Second Story Floor Area (%) (Percentage of First Story Building Footprint)	80	80	80	80	80	The second story cannot exceed 80 percent of the first story building footprint area.
<b>BUILDING RELATIONSHIP TO STREET</b>						
Maximum Front Yard Paving (%)	50	50	50	50	50	See Figure 2.2-3.
Street Facing Façade Design	Required. Street facing facades must be designed to orient towards the public street, or private street if lot does not abut public street. Windows, entry door, and other elements must be incorporated to create an attractive street appearance that enhances the surrounding neighborhood.					
Building Entrances on Streets	Required. The principal entry shall be located in a visible location from the public street, or private street if lot does not abut public street.					
Covered Front Porch or Covered Recessed Entry	Required.					
Minimum Depth (ft)	5	5	5	5	5	Alternative designs that create a welcoming entry feature visible from the street, such as a trellis or landscaped courtyard entry may be approved by Staff. See Figure 2.2-4.
Minimum Area of Porch and/or Recessed Entrance (sq ft)	5 percent of the first story building footprint area; up to a maximum of 100 square feet					

Table 2.2-1: Single-Family Subdivision Standards

<b>Standard<sup>1</sup></b>	<b>R-1</b>	<b>-B-8</b>	<b>-B-10</b>	<b>-B-20</b>	<b>-B-40</b>	<b>Additional Standards</b>
<b>SETBACKS FOR LIGHT AND AIR</b>						
Minimum Setbacks (ft)						Building site setbacks apply along the perimeter of a building site and lot setbacks apply to individual lots within a building site. In the event of conflict between building site setback requirements and lot setback requirements, the project must comply with whichever standard results in the greater setback.  Projects located in State Responsibility Fire Areas must maintain a 30 feet setback to other structures and property lines. Additional setbacks may be required from creeks and riparian corridors.
<b>Building Site (ft)</b>						
Front (Facing Public Street)	20	25	30	30	30	Must be landscaped.
Side (Facing Adjacent Neighboring Property)	5' + 1' for each full 10' by which the building site width exceeds 50', up to a maximum requirement of 10'	10	15	15	20	For R-1: Lot Width < 60' = Side Setback 5' Lot Width < 70' = Side Setback 6' Lot Width < 80' = Side Setback 7' Lot Width < 90' = Side Setback 8' Lot Width < 100' = Side Setback 9' Lot Width ≥ 100' = Side Setback 10'
Rear (Facing Adjacent Neighboring Property)	20	20	20	20	20	
<b>Lot (ft)</b>						
Front	20	25	30	30	30	Must be landscaped.
Side	5' + 1' for each full 10' by which the lot width exceeds 50', up to a maximum requirement of 10'	10	15	15	20	For R-1: Lot Width < 60' = Side Setback 5' Lot Width < 70' = Side Setback 6' Lot Width < 80' = Side Setback 7' Lot Width < 90' = Side Setback 8' Lot Width < 100' = Side Setback 9' Lot Width ≥ 100' = Side Setback 10'
Side, Corner	10					
Rear	20	20	20	20	20	



Table 2.2-1: Single-Family Subdivision Standards

<b>Standard<sup>1</sup></b>	<b>R-1</b>	<b>-B-8</b>	<b>-B-10</b>	<b>-B-20</b>	<b>-B-40</b>	<b>Additional Standards</b>
First Story Exception	10	10	10	10	10	Rear yard setback may be a minimum of 10 feet if that portion of the rear yard less than 20 feet in depth is compensated by open area within the same or adjacent yards on the same building site that exceed side and rear yard requirements by an area at least equal to extent of building coverage of the 20 feet rear yard with a minimum dimension of 10 feet. See Figure 2.2-6.
Second Story Exception	25	25	25	25	25	The second story is required to be set back a minimum of 25 feet from the rear property line if the second story exceeds 80 percent of the first story building footprint.
Setback From Access Driveway (ft)	10	10	10	10	10	Must be landscaped.
Setback From Access Driveway Exception (ft)	3	3	3	3	3	Landscaped setback from access driveway may be reduced to 3 feet on narrow building sites (typically less than 80 feet wide), with Staff approval. See Figure 2.2-7.
<b>AUTO CIRCULATION: SITE ACCESS AND DRIVEWAYS</b>						
Minimum Access Driveway/ Private Street Width (ft)	20	20	20	20	20	
Minimum Access Driveway/ Private Street Width Exception (ft)	12	12	12	12	12	Minimum 12 feet if lots are narrow and driveways serve fewer than 5 units. Fire Department may consider this exception if the rear-most corner of the rear-most building is within 150 feet of the curb and alternative means and methods are incorporated to meet Fire Code safety objectives.
Minimum Driveway Gates Setback (ft)	20	20	20	20	20	Gates are strongly discouraged. Gates across driveways shall be set back a minimum of 20 feet behind the property line, or greater depending on location in State Responsibility Fire Area and street travel speed.
<b>PARKING LOCATION AND DESIGN</b>						
Maximum Garage Width (ft)						See Figure 2.2-5.
Facing Public Street	Where garage doors face a public street, garage width shall not exceed 50 percent of the width of the front façade of the building.					
Facing Access Driveway/Private Street	Where garage doors face a private street or access driveway, garage width shall not exceed 60 percent of the width of the front façade of the building.					
For garages with three or more doors, or designed to accommodate three or more non-tandem parked cars see design guidelines section.						

Table 2.2-1: Single-Family Subdivision Standards

<b>Standard<sup>1</sup></b>	<b>R-1</b>	<b>-B-8</b>	<b>-B-10</b>	<b>-B-20</b>	<b>-B-40</b>	<b>Additional Standards</b>
Maximum Driveway Apron Width (ft)	Driveway apron width shall not exceed the garage door width by more than one foot in either direction.					Garage aprons leading to three-car garages shall be treated with decorative or permeable paving for a minimum of 35 percent of the driveway apron area.
Unit Parking (per dwelling unit)	2	2	2	2	2	Minimum of two spaces must be covered spaces in a garage or carport.
Guest Parking (per dwelling unit)	1	1	1	1	1	Space along the public street frontage of a building site can be counted towards guest parking requirements. However, guest spaces may be required to be on the building site if there is existing parking congestion, as defined by the Planning Director, on the street. A parking study may be required to determine existing parking congestion. Driveway aprons are not counted towards the required guest parking of a private single-family subdivision development.
<b>FACILITIES FOR PEDESTRIANS, BICYCLES, AND TRANSIT</b>						
Pedestrian Walkway Next to Access Driveway/Private Street	Required for 5 units or more					
Minimum Width of Pedestrian Walkway (ft)	4	4	4	4	4	
<b>SITE LANDSCAPING</b>						
Minimum Width of Landscaped Buffer Between Pedestrian Walkway and Access Driveway/Private Street (ft)	3	3	3	3	3	
Minimum Side Landscaping for Access Driveway/Private Street/Parking Area (ft)	5					Applies between the access driveway/private street/parking areas and the building site side and rear property lines.
Minimum Side Landscaping Exception (ft)	3					The minimum side landscaping shall be 3 feet when the building site width is less than 80 feet. Staff may approve a minimum side landscaping of 3 feet for building sites that are 80 feet or wider if vertical landscaping (e.g. trees, shrubs, bushes) is planted along this side landscaping area.

Note:

<sup>1</sup> For the -B-E Combining District, standards are as specified in the amendment creating the district.

## **Additional Hillside Standards**

This sub-section presents additional development standards for single-family home subdivisions in hillside areas.

The goal for the additional hillside standards is to ensure that hillside development is consistent in scale with existing neighborhoods and to ensure that height is minimized through development that steps down the hillside, following the slope of the land.

Figure 2.2-7: Single-Family Residential R-1 Hillside: Summary of Additional Major Development Standards

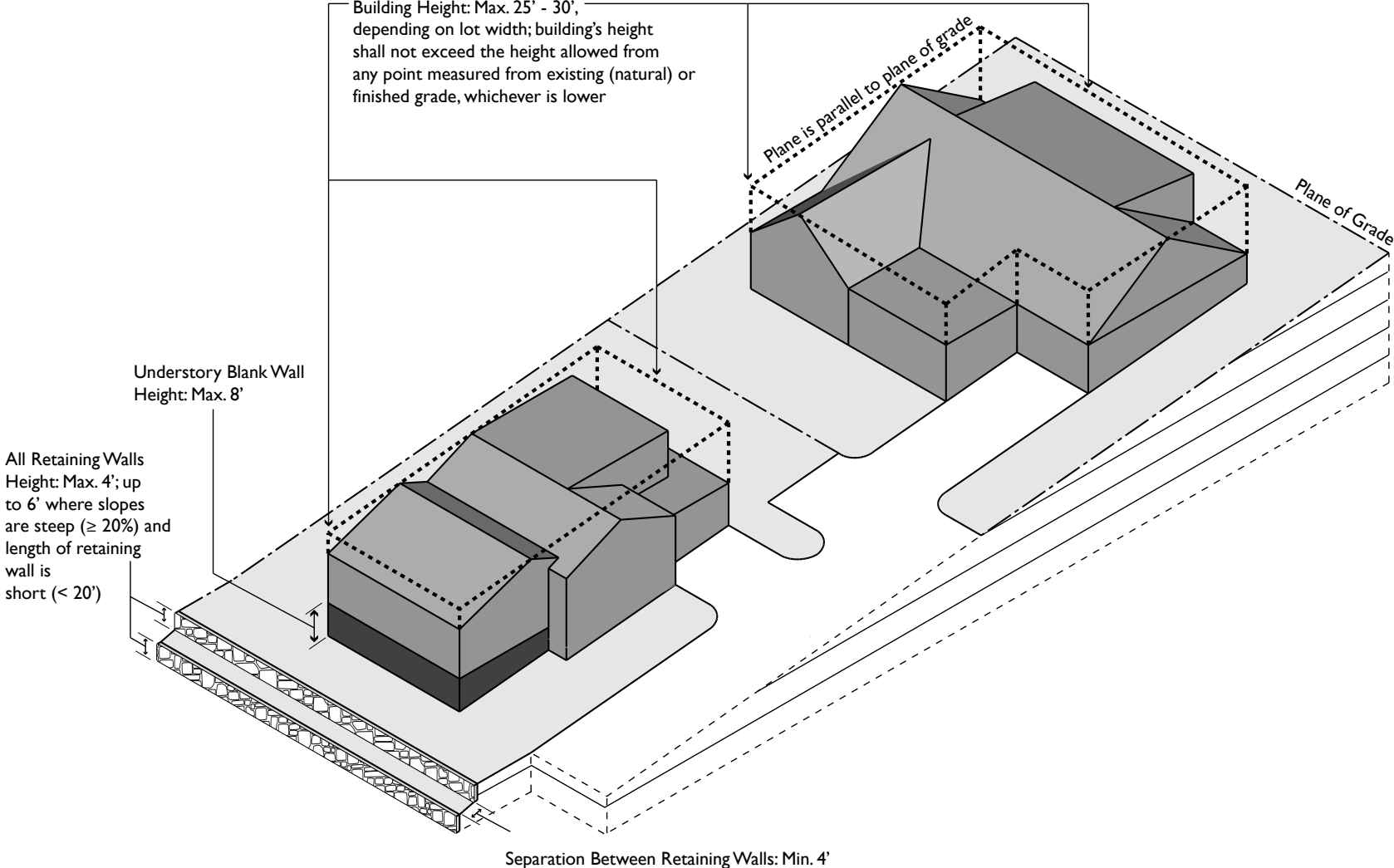
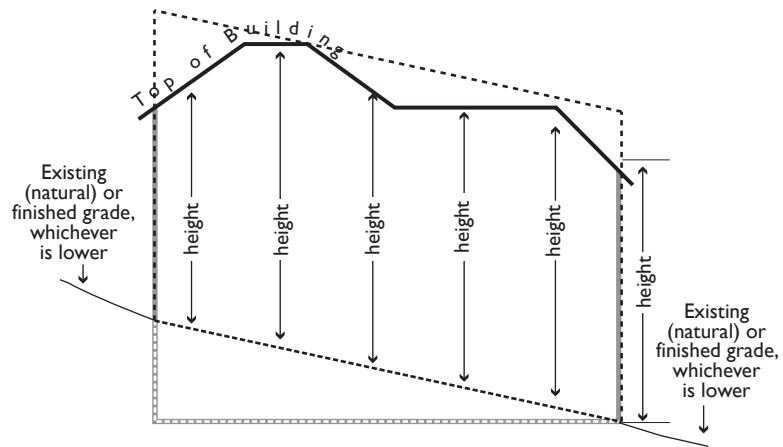
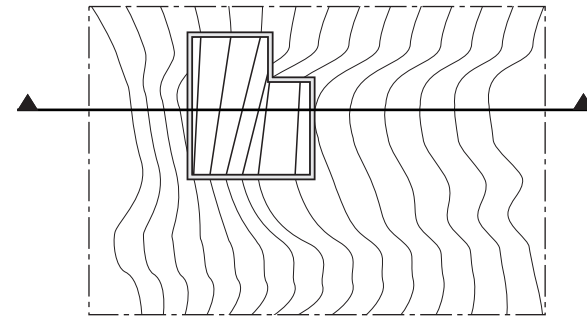


Figure 2.2-8: Single-Family Residential Hillside: Height

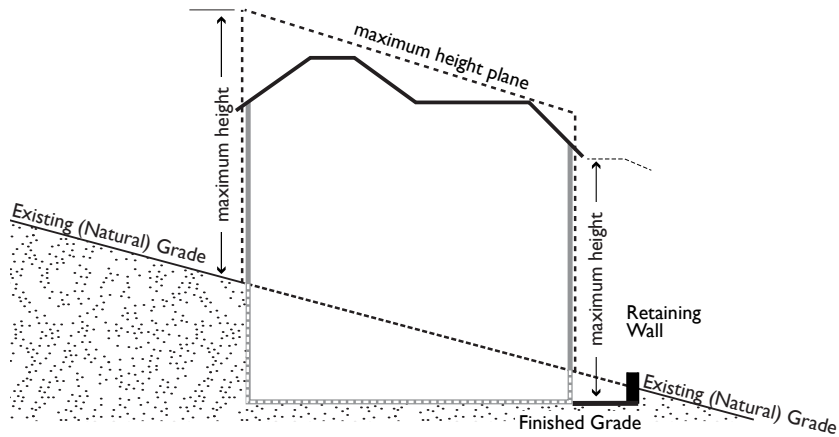


Cross-sectional illustration



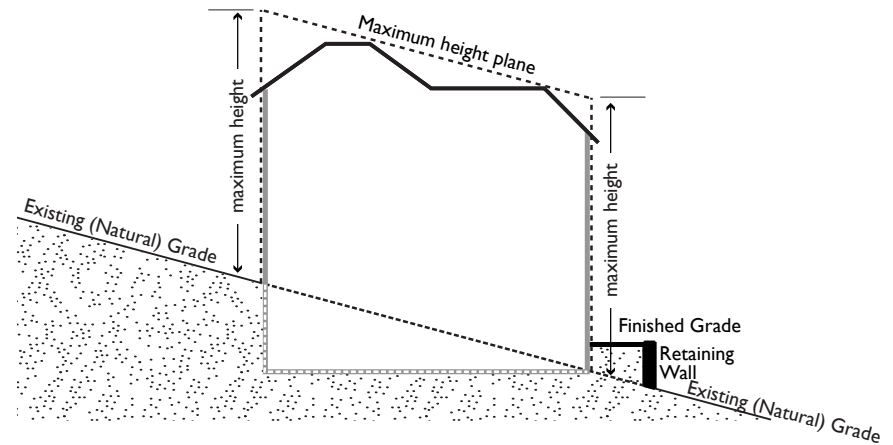
Plan View

When finished grade is lower than existing (natural) grade:



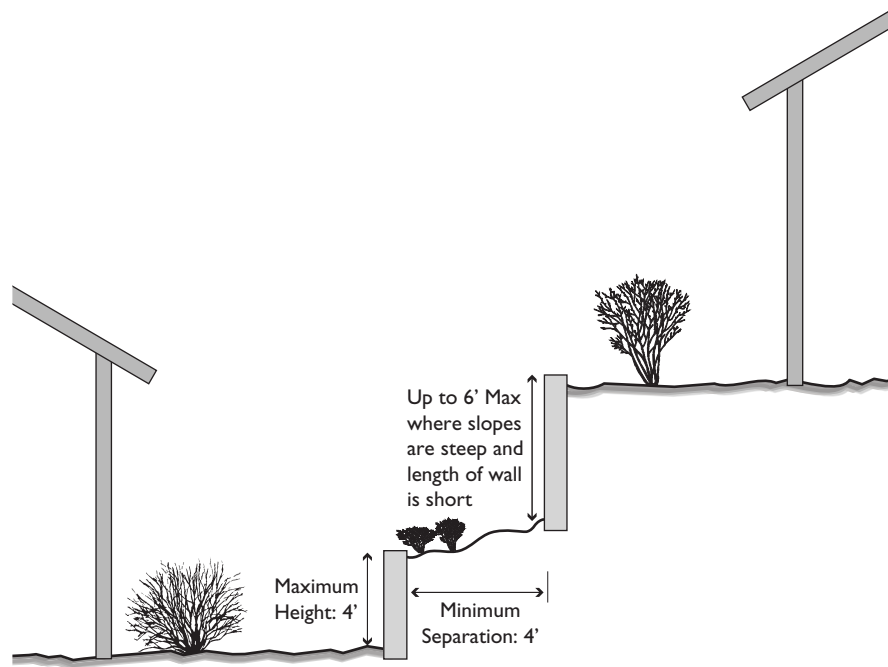
Finished grade is lower than existing (natural) grade so height is measured from finished grade

When existing (natural) grade is lower than finished grade:



Existing (natural) grade is lower than finished grade so height is measured from existing (natural) grade

Figure 2.2-9: Single-Family Residential Hillside: Retaining Wall Height



**TABLE 2.2-2: ADDITIONAL REGULATIONS FOR HILLSIDE LOTS**

<b>Standard</b>	<b>R-1<sup>1</sup></b>	<b>Madison Area Specific Plan</b>	<b>Fairview Area Specific Plan</b>	<b>Additional Standards</b>
	(Sites with average slope exceeding 10% gradient)	R-1, R-1-B-E, PD	R-1, R-1-B-E (Sites with average slope exceeding 10% gradient)	
<b>DEVELOPMENT INTENSITY AND NEIGHBORHOOD COMPATIBILITY</b>				
Minimum Building Site and Lot Size (sq ft)	5,000	5,000 - 40,000	5,000 - 5 acres	In addition, Castro Valley and Fairview require consistency with existing development in the area. See Chapter 7: Lot Size Consistency.
Maximum Slope of Building Site (%)	< 30	< 30	< 30	Locate buildings outside the areas of a parcel that has a slope of 30 percent or greater.
Minimum Lot Width (ft)	50			
Minimum Lot Width, Corner Lot (ft)	60			
Maximum Lot Coverage (%)	40		20 - 40	
One-Story Building (%)	45			
<b>BUILDING HEIGHT AND FORM</b>				
Maximum Height (ft)	25	25	25	Building height shall not exceed the height allowed from any and all points measured vertically from the structure perimeter at existing or finished grade, whichever is lower. The allowed structure height shall be at or below that imaginary plane located vertically above all of the points measured from the structure perimeter at existing or finished grade, whichever is lower. See Figure 2.2-9.
Height Exception (ft)	Up to 30	Up to 30	Up to 30	Provided that the roof is pitched and the portion of the roof over 25 feet in height is at least 15 feet away from building site property lines. See Figure 2.2-2.
Maximum Stories	2	2	2	Larger size homes shall incorporate a variety of roof forms and step down at the outer edges of the building.

Table 2.2-2: Additional Regulations for Hillside Lots

<b>Standard</b>	<b>R-1<sup>1</sup></b>	<b>Madison Area Specific Plan</b>	<b>Fairview Area Specific Plan</b>	<b>Additional Standards</b>
	(Sites with average slope exceeding 10% gradient)	R-1, R-1-B-E, PD	R-1, R-1-B-E (Sites with average slope exceeding 10% gradient)	
Stories Exception	3	3	3	
	Where the natural ground slope of a lot on the downhill side of the street is greater than one foot in seven feet as measured from the front lot line to the grade at the rear wall of the proposed building, one story in addition to the number permitted in the district in which the lot is situated is permitted on the downhill side of any building. The building height shall not otherwise exceed the limit specified for said district.			
<b>SETBACKS FOR LIGHT, AIR AND PRIVACY</b>				
Minimum Project and Lot Setbacks (ft)				Projects located in State Responsibility Fire Areas must maintain a 30 feet setback to other structures and property lines. Additional setbacks may be required from creeks and riparian corridors.
Front	Same as Standards in Table 2.2-1 for R-1	See Special Setbacks in Specific Plan	15 - 30 (As specified in the Specific Plan)	Must be landscaped.
Side	Same as Standards in Table 2.2-1 for R-1	Average 20; Minimum 10 See Special Setbacks in Specific Plan		
Rear	Same as Standards in Table 2.2-1 for R-1	Same as Standards in Table 2.2-1 for R-1	Same as Standards in Table 2.2-1 for R-1	
<b>USABLE OPEN SPACE</b>				
Minimum Private Usable Open Space (sq ft)			1,000	Private, usable open space area is considered: <ul style="list-style-type: none"> <li>• Areas not visible from the fronting street;</li> <li>• Areas with a ground slope of less than 20 per cent gradient;</li> <li>• Areas not covered by off street parking or any access thereto;</li> <li>• Any open area with a minimum 15 feet in its least dimension; and</li> <li>• Roof-top areas designed for outdoor residential use or outside deck spaces more than 8 feet in least dimension.</li> </ul>
Minimum Ground Floor Dimension (ft)			15	
Minimum Deck/Balcony Dimension (ft)			8	



Table 2.2-2: Additional Regulations for Hillside Lots

<b>Standard</b>	<b>R-1<sup>1</sup></b>	<b>Madison Area Specific Plan</b>	<b>Fairview Area Specific Plan</b>	<b>Additional Standards</b>
	(Sites with average slope exceeding 10% gradient)	R-1, R-1-B-E, PD	R-1, R-1-B-E (Sites with average slope exceeding 10% gradient)	
<b>WALLS</b>				
Maximum Height of Understory Blank Walls (ft)	8	8	8	
Maximum Retaining Wall Height (ft)	4 - 6	4 - 6	4 - 6	See Figure 2.2-9.
	Limit the height of all retaining walls to four feet, and require a minimum four-foot horizontal separation between retaining walls. Allow up to six feet retaining walls in special circumstances where slopes are steep (greater than or equal to 20 percent) and the length of the retaining wall is short (less than 20 feet in length.)			

Note:

<sup>1</sup> For the -B-E Combining District in areas outside of the Fairview and Madison Area Specific Plan areas, standards are as specified in the amendment creating the district.

*Page Intentionally Left Blank*

## 2.3 Small-Lot Single-Family Home Standards

This section presents the development standards for small-lot single-family homes.

The purpose of the small-lot single-family home standards is to allow for a variety of housing types in the unincorporated areas of West Alameda County while also achieving neighborhood goals for an attractive street appearance. The standards are also to ensure that basic needs for sunlight, privacy, ventilation, recreation area and parking are provided.

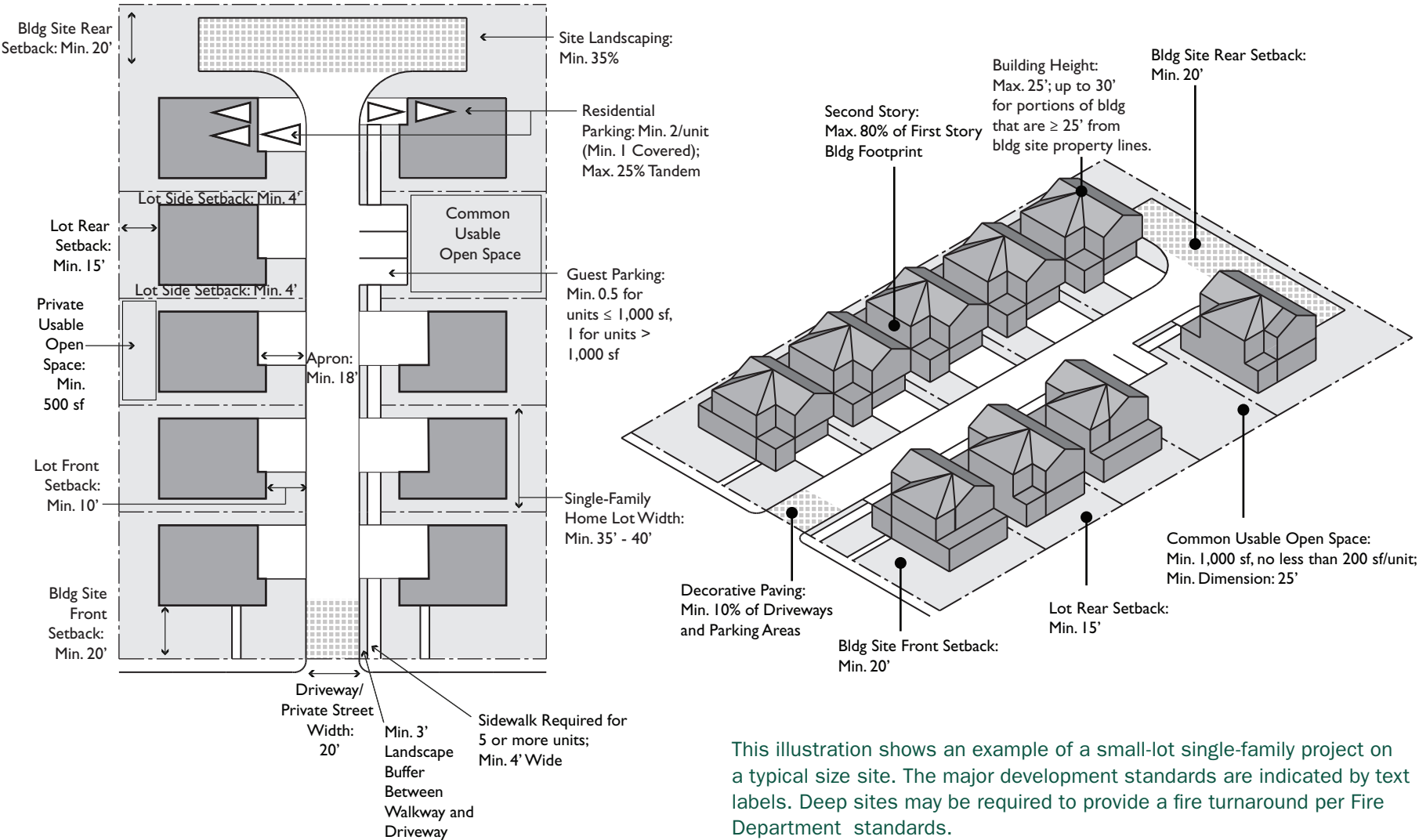
Small-lot single-family homes are detached units that are typically smaller than single-family homes and require a minimum building site of 3,500 to 5,000 square feet per dwelling unit.

Small-lot single-family homes are appropriate in the R-S, R-S-D35, and R-S-DV Zoning Districts. These districts are located in Cherryland and Hayward Acres.



Figure 2.3-1: Small-Lot Single-Family Homes: Summary of Major Development Standards

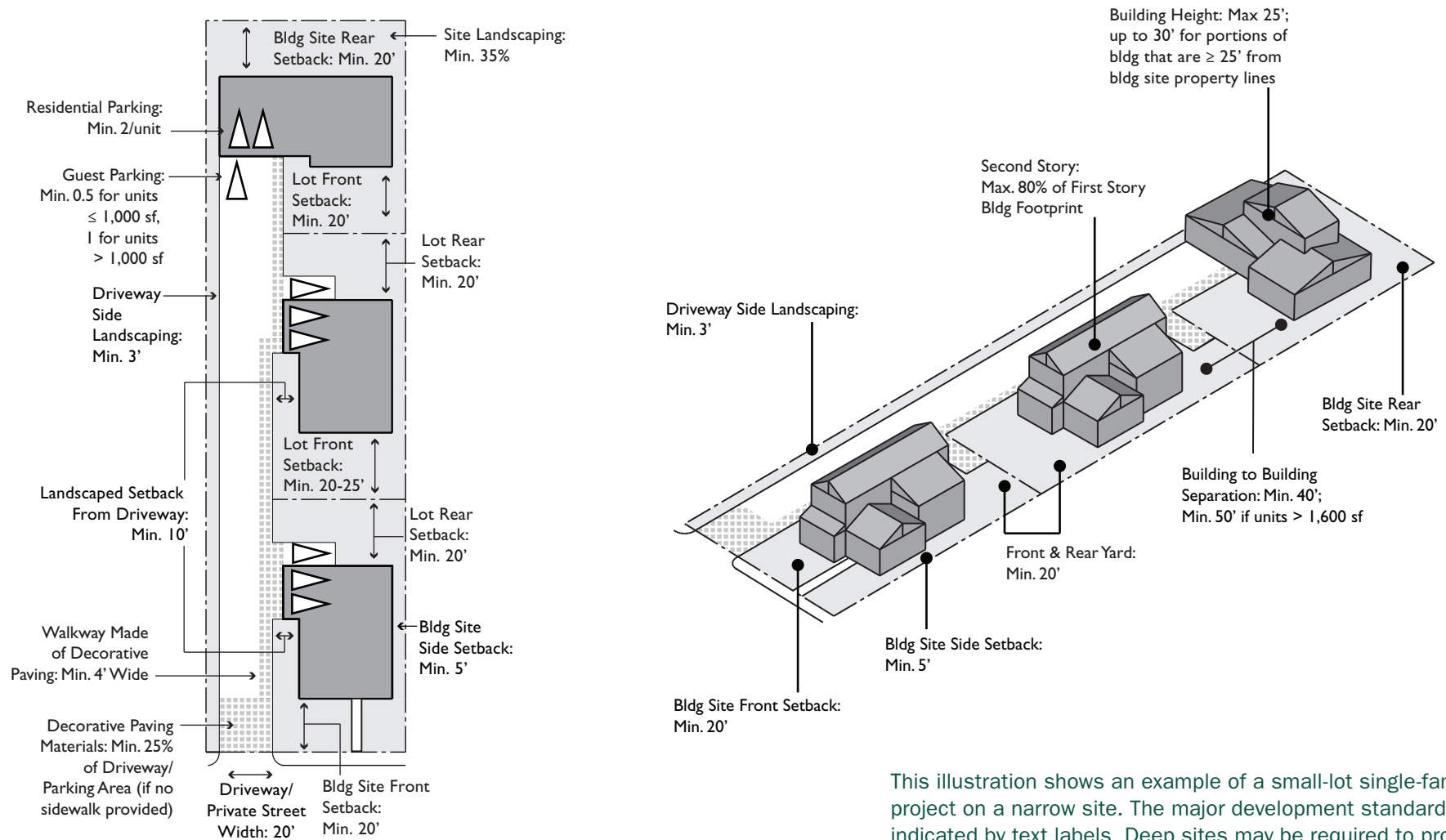
Note: Diagrams not to be used for density calculations.



This illustration shows an example of a small-lot single-family project on a typical size site. The major development standards are indicated by text labels. Deep sites may be required to provide a fire turnaround per Fire Department standards.

Figure 2.3-2: Small-Lot Single-Family Homes: Narrow Lot (60' to 75' Wide): Summary of Major Development Standards

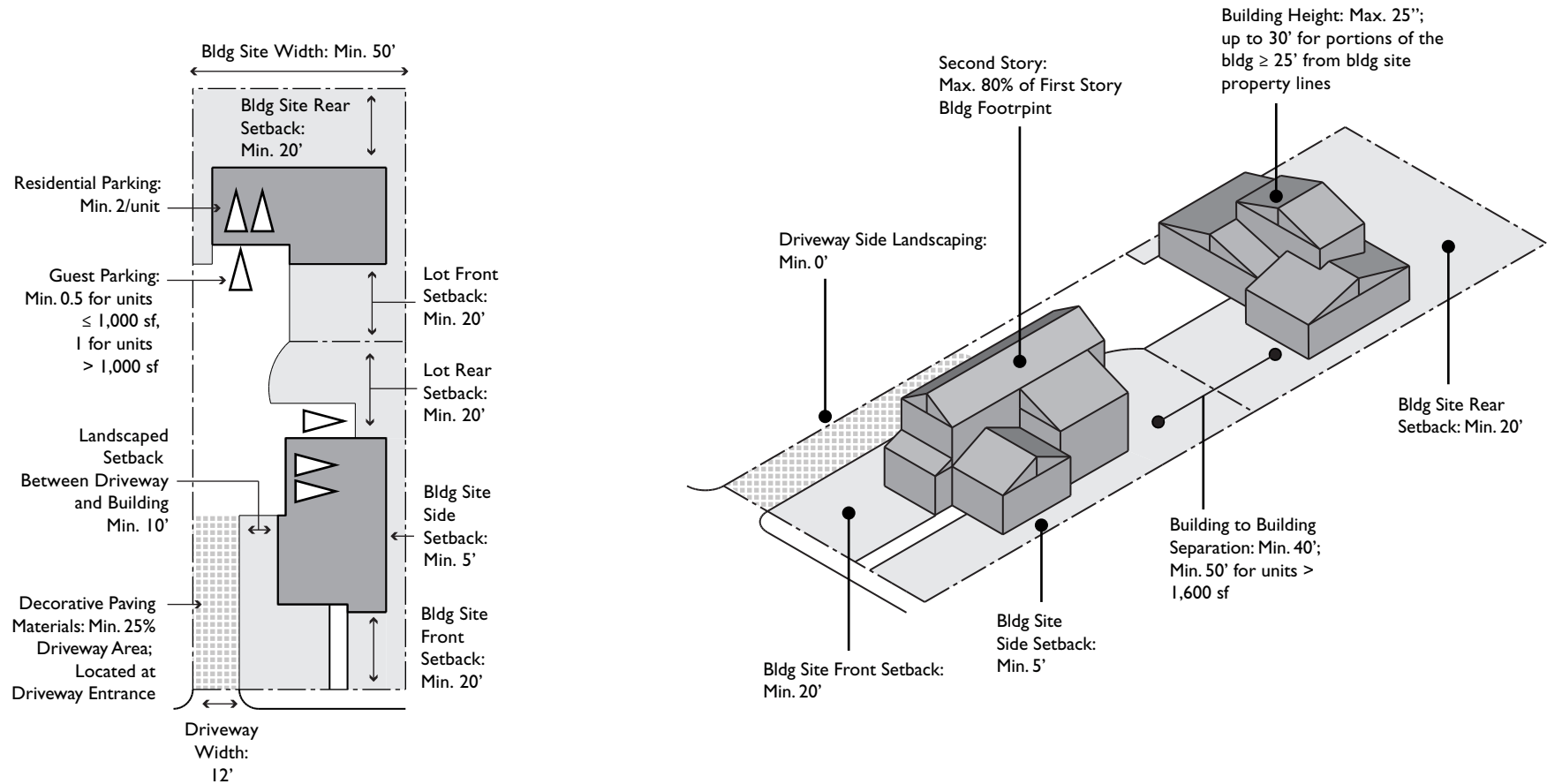
Note: Diagrams not to be used for density calculations.



This illustration shows an example of a small-lot single-family project on a narrow site. The major development standards are indicated by text labels. Deep sites may be required to provide a fire turnaround per Fire Department standards.

Figure 2.3-3: Small-Lot Single-Family Homes: Narrow Lot (Lots < 60' Wide, Maximum Two Units): Summary of Major Development Standards

Note: Diagrams not to be used for density calculations.



This illustration shows an example of a small-lot single-family project on a narrow site. The major development standards are indicated by text labels.

Figure 2.3-4: Small-Lot Single-Family: Height

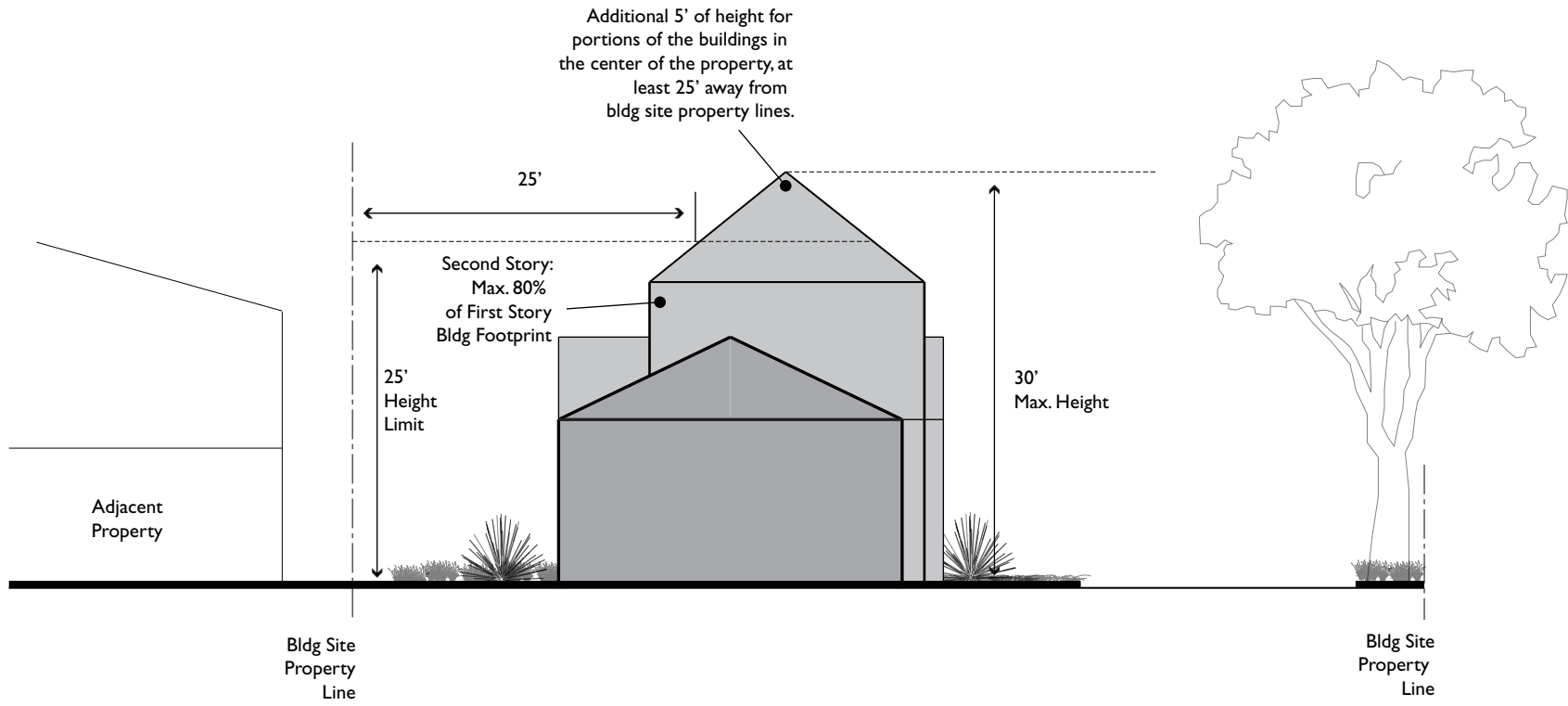


Figure 2.3-5: Small-Lot Single-Family: Front Yard Paving and Gates

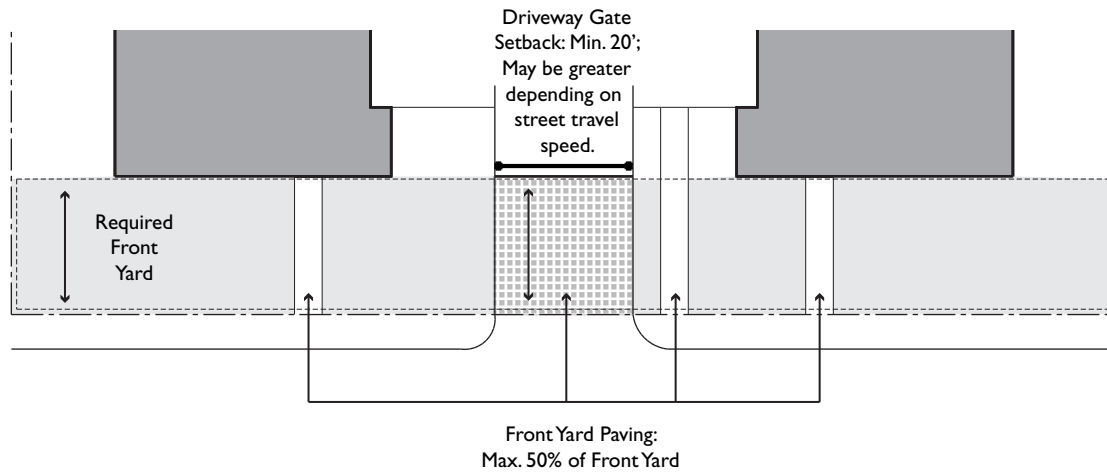


Figure 2.3-6: Small-Lot Single-Family: Front Porch or Covered Recess

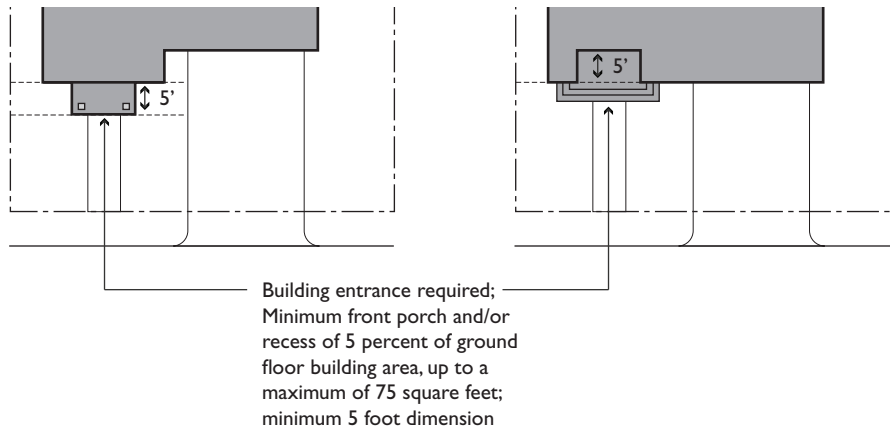




Figure 2.3-7: Small-Lot Single-Family: Interior Elevation

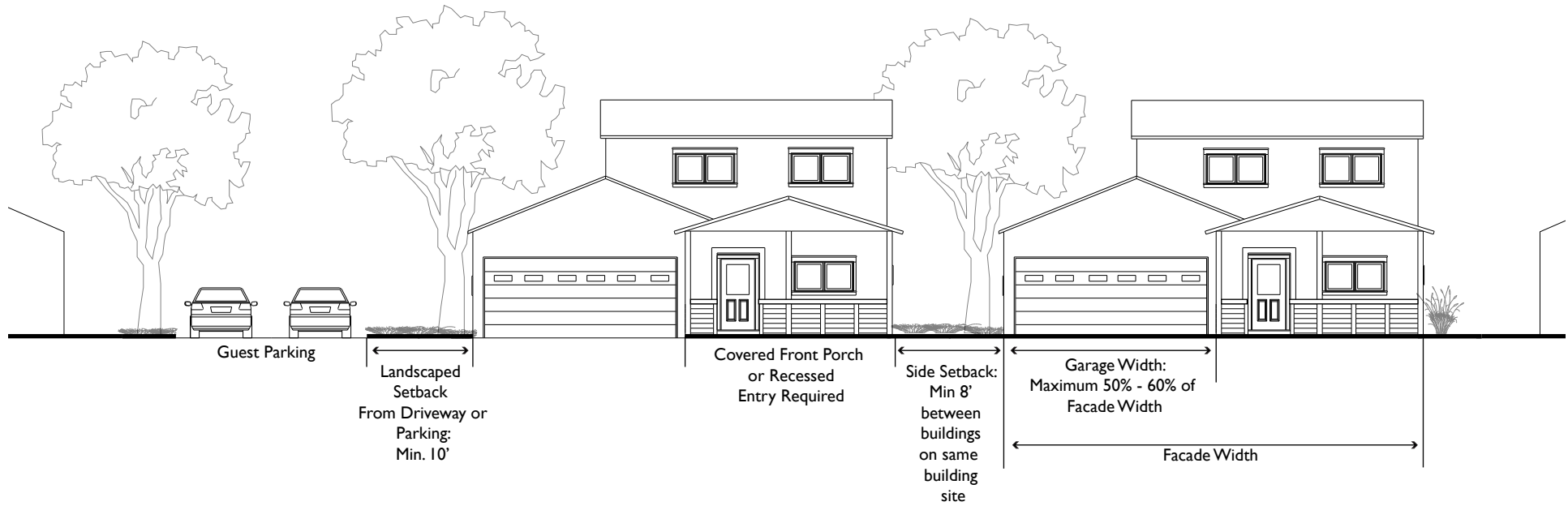


Figure 2.3-8: Small-Lot Single-Family: Garage Aprons

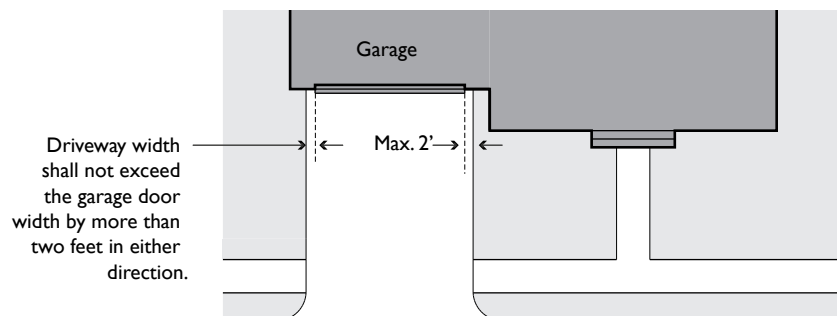
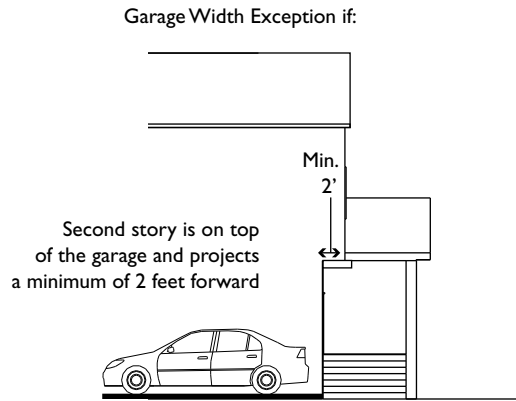


Figure 2.3-9: Small-Lot Single-Family: Garage Exception



or

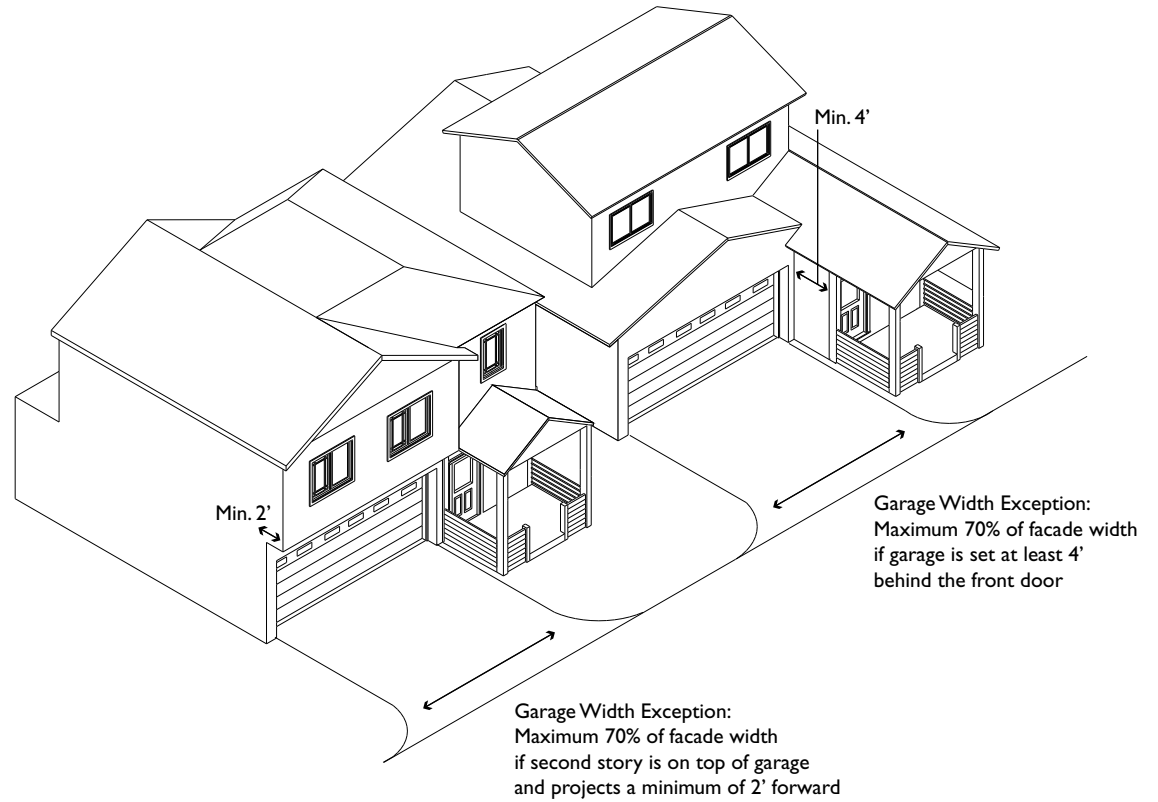
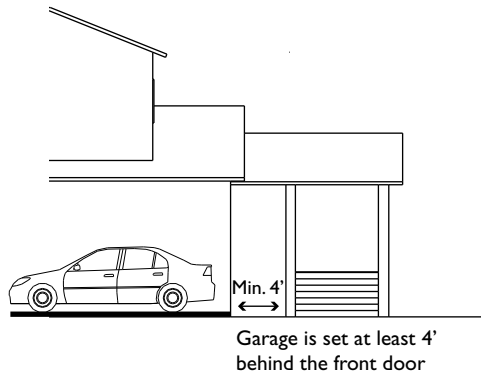


Figure 2.3-10: Small-Lot Single-Family: Side Setbacks

Building Site Width  $\geq$  80':  
Second story max. 80% of  
first story footprint; a minimum  
of 50% of the required bulk  
reduction shall occur along  
the building site  
side property line.

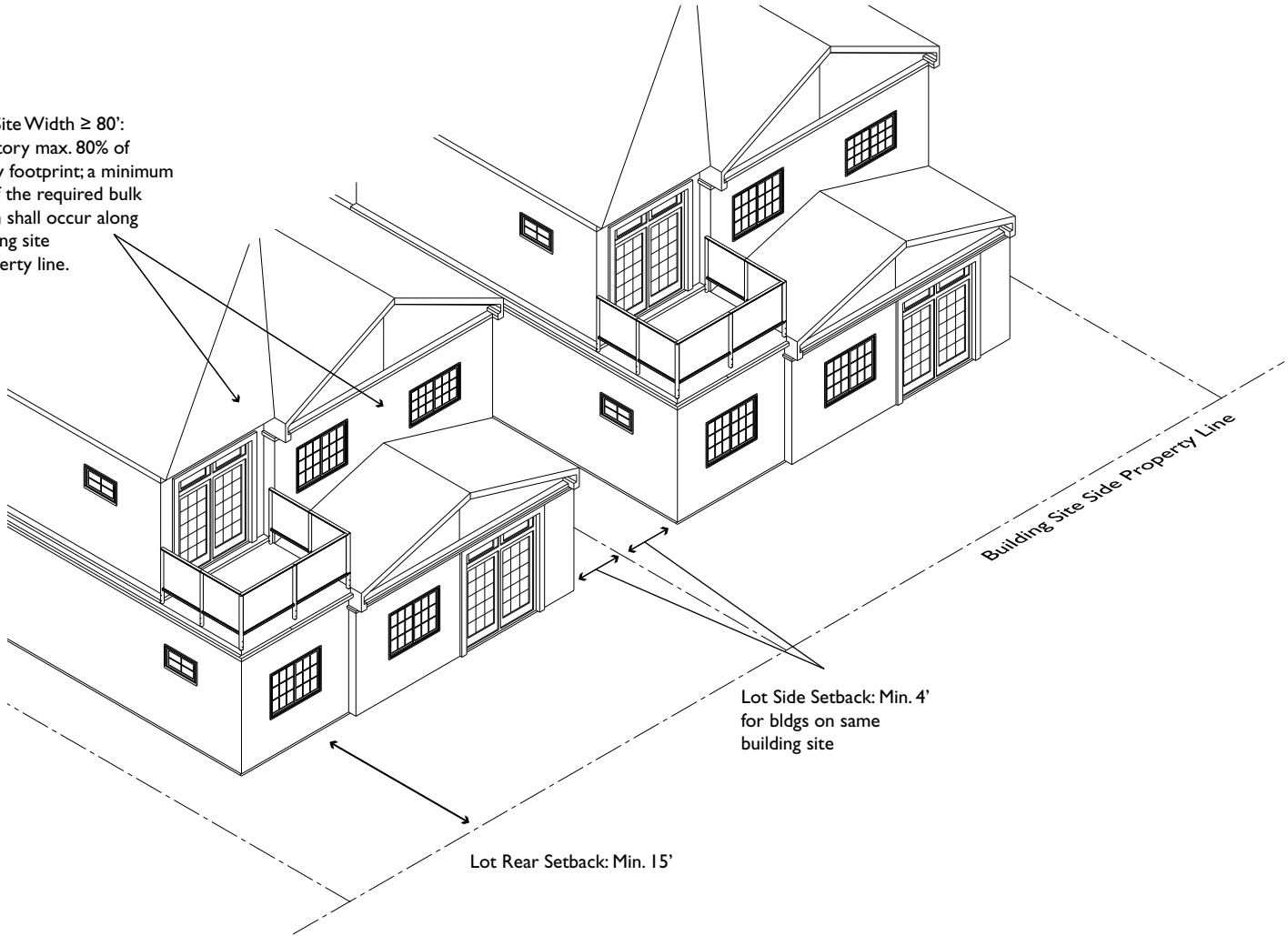
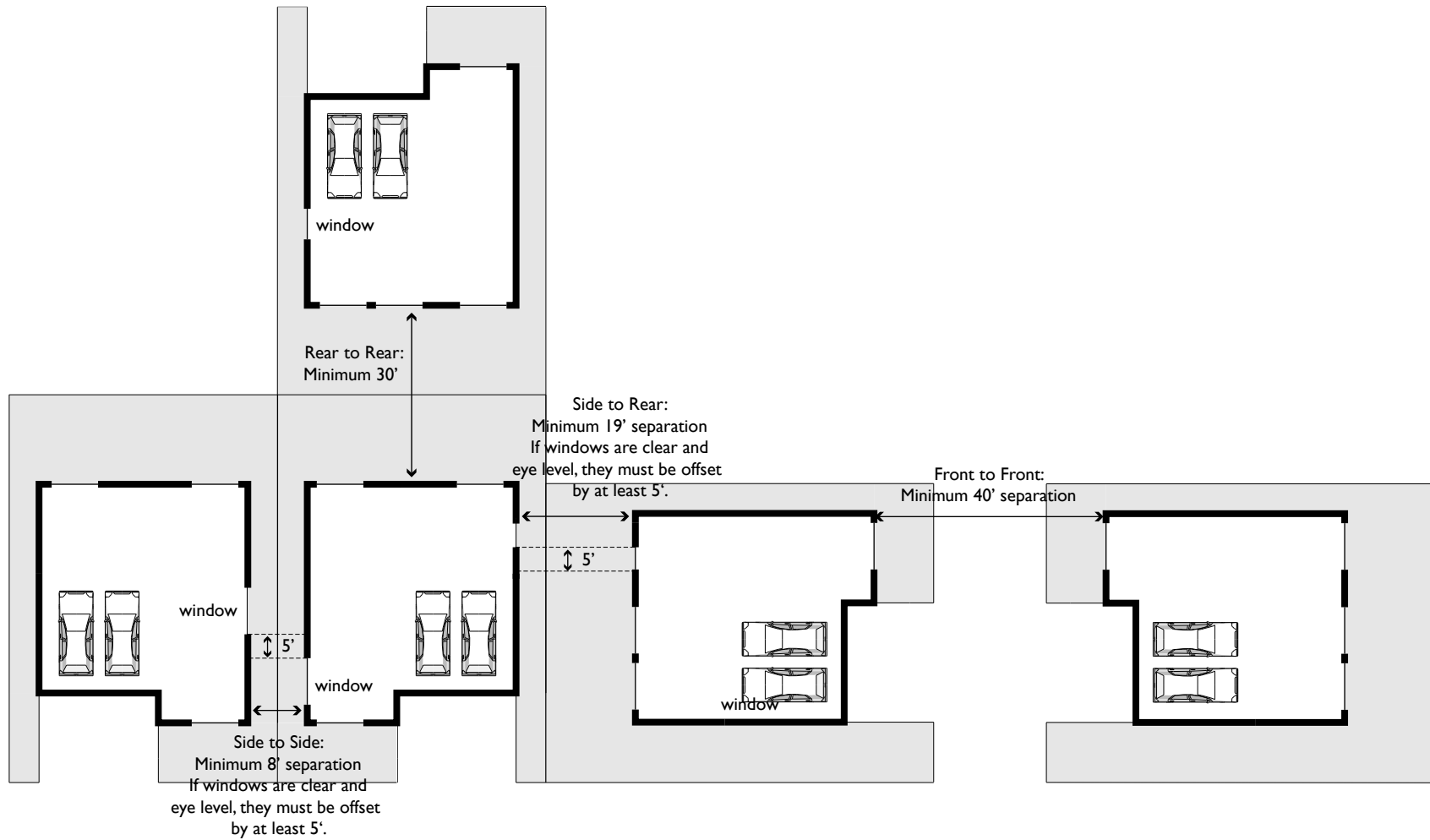


Figure 2.3-11: Small-Lot Single-Family: Minimum Distance Between Buildings



**TABLE 2.3-1: SMALL-LOT SINGLE FAMILY HOMES**

<b>Standard</b>	<b>R-S, R-S-D35, R-S-DV (with lot width &lt; 100' and lot area &lt; 20,000 sq ft)</b>	<b>Additional Standards</b>
<b>DEVELOPMENT INTENSITY AND NEIGHBORHOOD COMPATIBILITY</b>		
Minimum Building Site Size (sq ft)	5,000	
Minimum Area per Dwelling Unit (sq ft)		
R-S	5,000	If the width of a building site is less than 60 feet, the maximum number of small-lot single-family units allowed on the site is two and the minimum area per two small-lot single-family residential dwelling units is 7,500 square feet.
R-S-D35, R-S-DV	3,500	
Minimum Building Site Width (ft)	50	
Minimum Lot Width (ft)	40	
Minimum Lot Width Exception (ft)	30 - 35	A lot width of 35 feet may be necessary for small-lot single-family homes with attached double loaded garages in front and to comply with Parking Location and Design requirements. Lot width may be reduced to 30 feet if garages are single-car wide, detached and/or accessed from an alley.
<b>BUILDING HEIGHT AND FORM</b>		
Maximum Height (ft)	25	
Height Exception (ft)	30	Provided that the roof is pitched and the portion of the roof over 25 feet in height is at least 25 feet away from building site property lines. See Figure 2.3-4.
Maximum Stories	2	
Maximum Second Story Floor Area (%)	80	The second story floor area shall not exceed 80 percent of the first story building footprint area.
<b>BUILDING RELATIONSHIP TO THE STREET</b>		
Maximum Front Yard Paving (%)	50	See Figure 2.3-5.
Street Facing Façade Design	Required. Street facing facades must be designed to orient towards the public street, or private street if lot does not abut a public street. Windows, entry door, and other elements must be incorporated to create an attractive street appearance that is compatible with the surrounding neighborhood.	
Building Entrances on Streets	Required. The principal entry shall be located in a visible location facing the public street, or private street if lot does not abut public street.	
Covered Front Porch or Covered Recessed Entry	Required.	
Minimum Depth (ft)	5	Alternative designs that create a welcoming entry feature facing the street, such as a trellis or landscaped courtyard entry may be approved by Staff. See Figure 2.3-6.
Minimum Area of Porch and/or Recessed Entrance (sq ft)	5 percent of the first story building footprint area; up to a maximum of 75 square feet	

Table 2.3-1: Small-Lot Single-Family Homes

<b>Standard</b>	<b><i>R-S, R-S-D35, R-S-DV (with lot width &lt; 100' and lot area &lt; 20,000 sq ft)</i></b>	<b>Additional Standards</b>
<b>SETBACKS FOR LIGHT, AIR AND PRIVACY</b>		
Minimum Setbacks (ft)		Building site setbacks apply along the perimeter of a building site and lot setbacks apply to individual lots within a building site. In the event of conflict between building site setback requirements and lot setback requirements, the project must comply with whichever standard results in the greater setback.
Building Site		
Front (Facing Public Street)	20	Must be landscaped.
Side (Facing Adjacent Neighboring Properties)	5	A minimum of 50 percent of the required bulk reduction must occur along the building site side property line.  If a building is at or within 5 feet of this property line, a minimum of 50 percent of the second story facade shall be stepped back a minimum of 5 feet from the first story facade and a minimum of half of that required amount shall occur along this side setback.
Rear (Facing Adjacent Neighboring Properties)	20	
Lot (ft)		
Front	10	Must be landscaped.
Front Exception	20	If a building site width is less than 80 feet, the minimum front setback for a lot shall be 20 feet.
Side	8	Lot side yard setbacks are between buildings on the same building site.
Side Exception	Zero Lot Line	A zero lot line is permitted if the adjacent side yard is double the required amount. A zero lot line is not permitted next to adjacent neighboring property.
Rear	15	
Rear Exception	20	If a building site width is less than 80 feet, the minimum rear setback for a lot shall be 20 feet.
Minimum Distance Between Buildings (ft)		Front is considered any wall with windows into the primary living area of the unit. See Figure 2.3-10.
Front to Front or Rear	40	For building sites less than 80 feet in width, the minimum distance shall be 50 feet if units have a floor area of more than 1,600 square feet.
Rear to Rear	30	For building sites less than 80 feet in width, the minimum distance shall be 40 feet and the minimum distance shall be 50 feet if units have a floor area of more than 1,600 square feet.
Side to Front or Rear	19	If windows are clear and eye-level, they must be offset by at least 5 feet.
Side to Side	8	If windows are clear and eye level, they must be offset by at least 5 feet.
Minimum Setback From Access Driveway (ft)	10	Minimum Setback from Access Driveway for projects with 5 or more units is 10 feet and must be fully landscaped. Requires a walkway to each unit.  Minimum Setback from Access Driveway for projects with fewer than 5 units is 5 feet and must be fully landscaped. No walkway is required. If walkway is installed, it must be outside of required setback to driveway.

Table 2.3-1: Small-Lot Single-Family Homes

<b>Standard</b>	<b>R-S, R-S-D35, R-S-DV (with lot width &lt; 100' and lot area &lt; 20,000 sq ft)</b>	<b>Additional Standards</b>
Setback From Access Driveway Exception (ft)	7.5	The minimum setback from an access driveway for projects with 5 or more units shall be 7.5 feet when the building site width is less than or equals 60 feet. For projects with fewer than 5 units and a building site width is less than or equal to 60 feet, the minimum setback of the front unit from the access driveway is 5 feet. In both instances, the setback must be fully landscaped and any walkway, if installed, must be outside of that setback.
<b>AUTO CIRCULATION: SITE ACCESS AND DRIVEWAYS</b>		
Minimum Access Driveway/Private Street Width (ft)	20	
Minimum Access Driveway/Private Street Width Exception	12	Minimum 12 feet if lots are narrow and driveways serve fewer than 5 units. Fire Department may consider this exception if the rear-most corner of the rear-most building is within 150' of the curb and alternative means and methods are incorporated to meet Fire Code safety objectives.
Maximum Curb Cuts (number per building site)	1	Exception may be granted by Staff if building site exceeds one acre, building site frontage exceeds 200 feet, or through lot.
Minimum Driveway Gates Setback (ft)	20	Gates across driveways shall be set back a minimum of 20 feet behind the property line, or greater depending on location in State Responsibility Fire Area and street travel speed.
<b>PARKING LOCATION AND DESIGN</b>		
Maximum Garage Width (ft)	20	
Facing Public Street	Where garage doors face a public street, garage width shall not exceed 50 percent of the width of the front facade of the building.	
Facing Access Driveway/Private Street	Where garage doors face a private street or access driveway, garage width shall not exceed 60 percent of the width of the front facade of the building.	
Garage Width Exception	Where garage doors face a private street or access driveway, garage width shall not exceed 70 percent of the width of the front facade of the building if the garage (wall to wall) is set at least four feet behind the front door or a second story above the garage projects at least two feet forward in front of the garage. See Figure 2.3-9.	
Maximum Driveway Apron Width (ft)	Driveway apron widths shall not exceed the garage door width by more than one foot in either direction. See Figure 2.3-8	
Unit Parking (space per unit)	20	Minimum of one space must be covered. Tandem parking allowed for up to 25 percent of the units.
Guest Parking (space per unit)		Space along the public street frontage of a building site can be counted towards guest parking requirements. However, guest spaces may be required to be on the building site if there is existing parking congestion, as defined by the Planning Director, on the street. A parking study may be required to determine existing parking congestion. Driveway aprons may be counted for the required guest parking.
Units ≤ 1,000 sq ft	0.5	
Units > 1,000 sq ft	1	
<b>FACILITIES FOR PEDESTRIANS, BICYCLES, AND TRANSIT</b>		
Minimum Decorative Driveway Paving (% of Driveway and Parking Area)	10	Locate at driveway entrances, driveway aprons and in areas that can be used as open space.

Table 2.3-1: Small-Lot Single-Family Homes

<b>Standard</b>	<b>R-S, R-S-D35, R-S-DV (with lot width &lt; 100' and lot area &lt; 20,000 sq ft)</b>	<b>Additional Standards</b>
Minimum Decorative Driveway Paving Exception (%)	25	Required if there is no pedestrian walkway/sidewalk provided along the access driveway/private street. A minimum 4 foot wide walkway consisting of decorative paving shall also be provided. Walkway consisting of decorative paving is not required to be provided if there are two units on a building site.
Pedestrian Walkway Next to Access Driveway/Private Street	Required for 5 units or more	For fewer than 5 units, may have no sidewalk if driveway pavement has differentiated pedestrian paving.
Minimum Width of Pedestrian Walkway (ft)	4	
<b>SITE LANDSCAPING</b>		
Minimum Site Landscaping (%)	35	
Minimum Width of Landscaped Buffer Between Pedestrian Walkway and Access Driveway/Private Street (ft)	3	
Minimum Width of Side Landscaping for Driveway/Private Street/Parking Area (ft)	5	Applies between the driveway/private street/parking areas and the side and rear property lines.
Minimum Side Landscaping Exception (ft)	0 - 3	The minimum driveway side landscaping shall be 3 feet when building site width is less than 75 feet and greater or equal to 60 feet. The minimum driveway side landscaping shall be 0 feet when the building site width is less than 60 feet. Staff may approve a minimum side landscaping of 3 feet for building sites that are 75 feet or wider if vertical landscaping (e.g. trees, shrubs, bushes) is planted along this side landscaping area.
<b>USABLE OPEN SPACE</b>		
Minimum Total Usable Open Space (sq ft per unit)	600	Common usable open space is not required for projects with four units or fewer, provided that each small-lot single-family unit has a minimum of 500 square feet of private open space.
Minimum Common Usable Open Space (sq ft)	1,000 square feet; no less than 200 square feet per unit	Common space buildings or covered structures cannot occupy more than 20 percent of common open space.
Minimum Dimension (ft)	25	
Minimum Private Usable Open Space (sq ft per unit)	500	Private open space must be open air, not fully enclosed with walls. Private open space cannot be covered by a roof by more than 50 percent of the area; however balconies can have up to 100 percent ceiling coverage.



## 2.4 Townhome Standards

This section presents the development standards for townhomes. The purpose of the townhome standards is to allow for a variety of housing types in the unincorporated areas of Alameda County while also achieving neighborhood goals for an attractive street appearance. The standards are also to ensure that basic needs for sunlight, privacy, ventilation, recreation area and parking are provided.

Townhomes are two or three story attached units, with an individual entry on the ground floor and a private yard area. Attached garages are characteristic of this building type, but parking may also be in the form of detached garages or parking courts. Townhome projects may be structured as fee-simple lots or as a condominium subdivision; they may also be rental units.

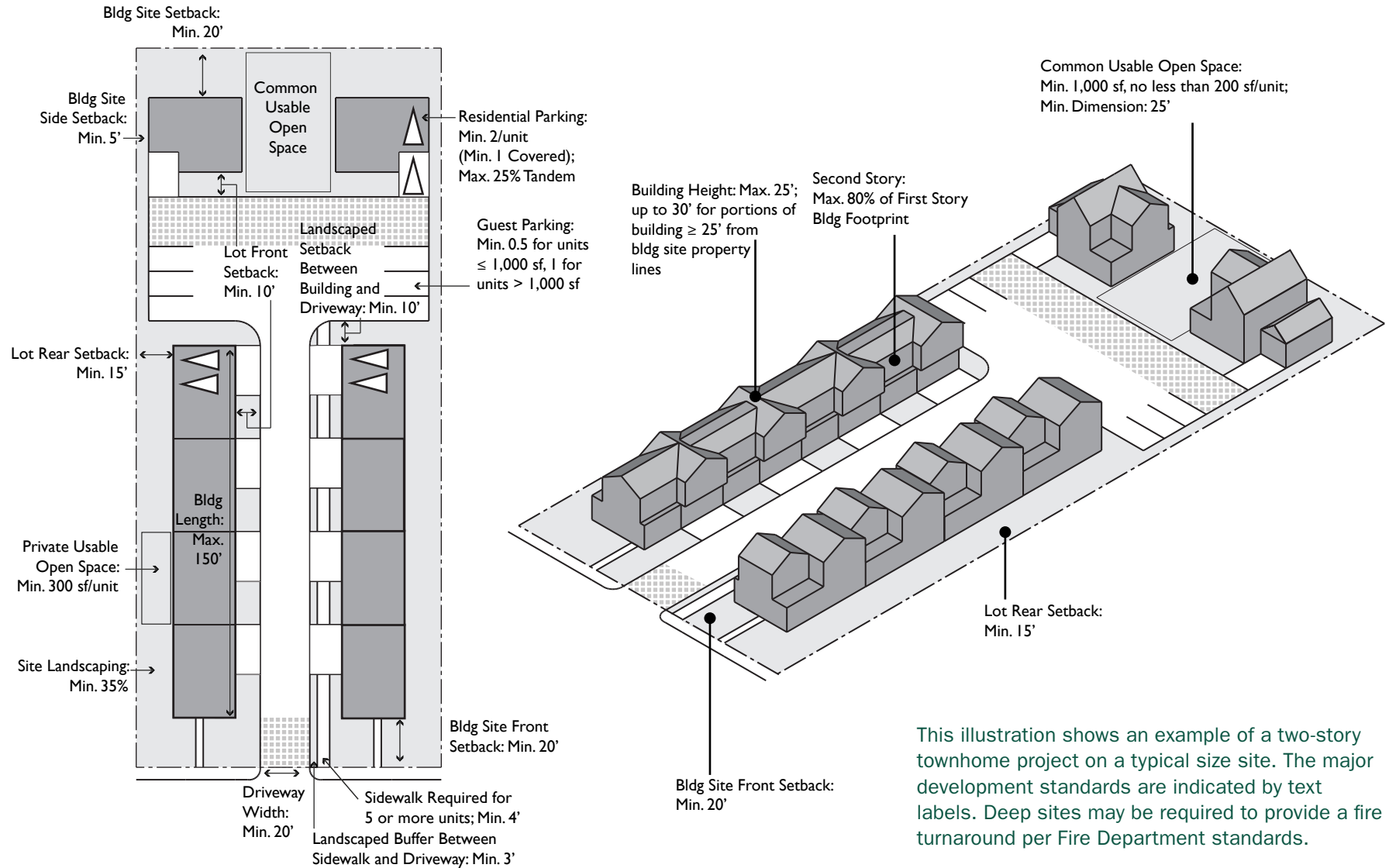
Two-story townhomes require a minimum building site of 2,500 to 3,500 square feet per dwelling unit while three-story townhomes require a minimum 2,000 to 2,500 square feet per dwelling unit. Three-story townhomes are appropriate on larger building sites (sites that are 20,000 square feet or more and with a minimum width of 100 feet) so the extra height can be away from property lines.

These standards apply to townhomes, which are appropriate in the R-S-D35, R-S-D25, R-2, R-S-D3, R-S-D20, R-S-DV, and R-3 Zoning Districts. These districts are predominantly located in Cherryland, Ashland and Hayward Acres.



Figure 2.4-1: Two-Story Townhomes: Summary of Major Development Standards

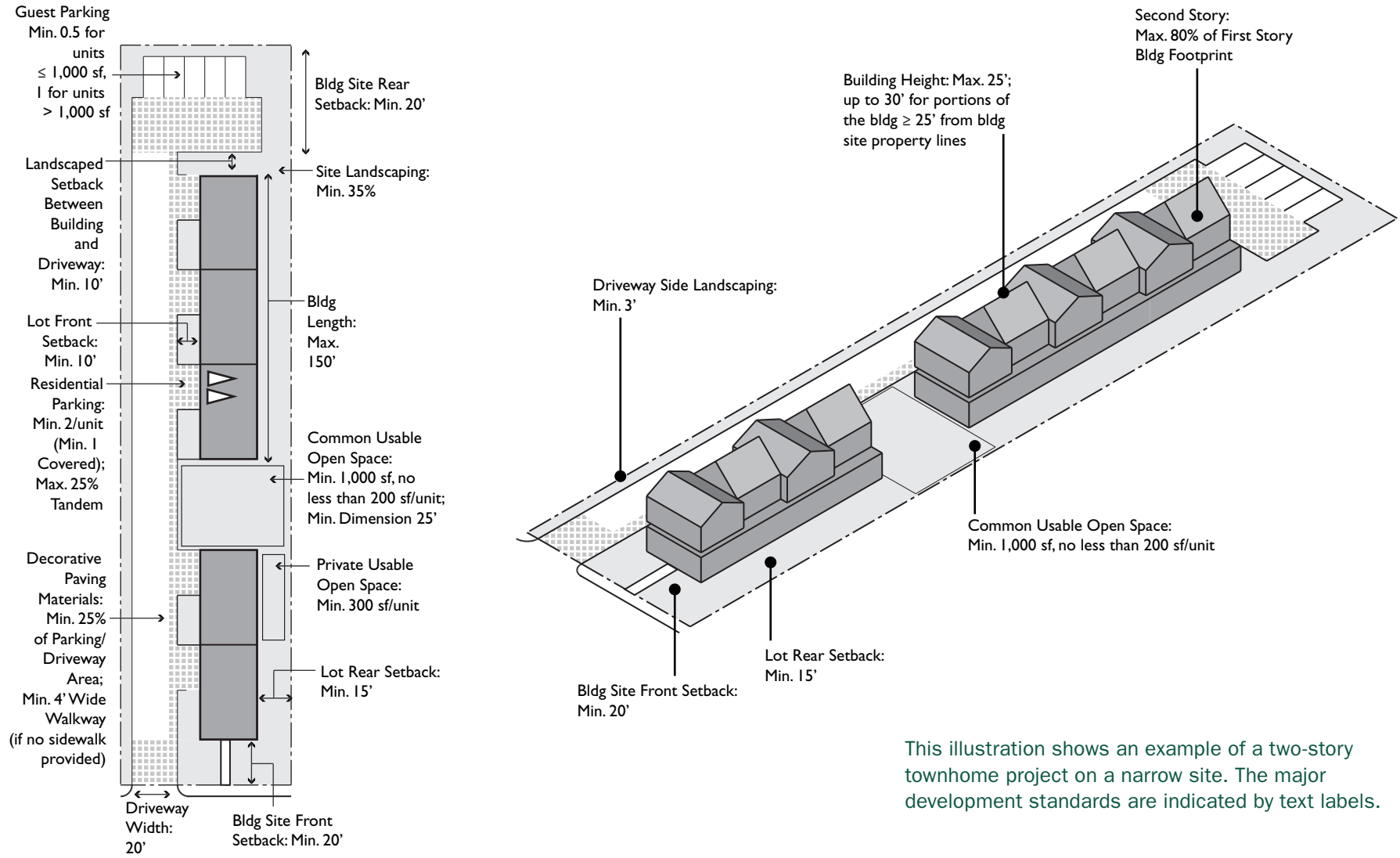
Note: Diagrams not to be used for density calculations.



This illustration shows an example of a two-story townhome project on a typical size site. The major development standards are indicated by text labels. Deep sites may be required to provide a fire turnaround per Fire Department standards.

Figure 2.4-2: Townhomes on Narrow Lots: Summary of Major Development Standards

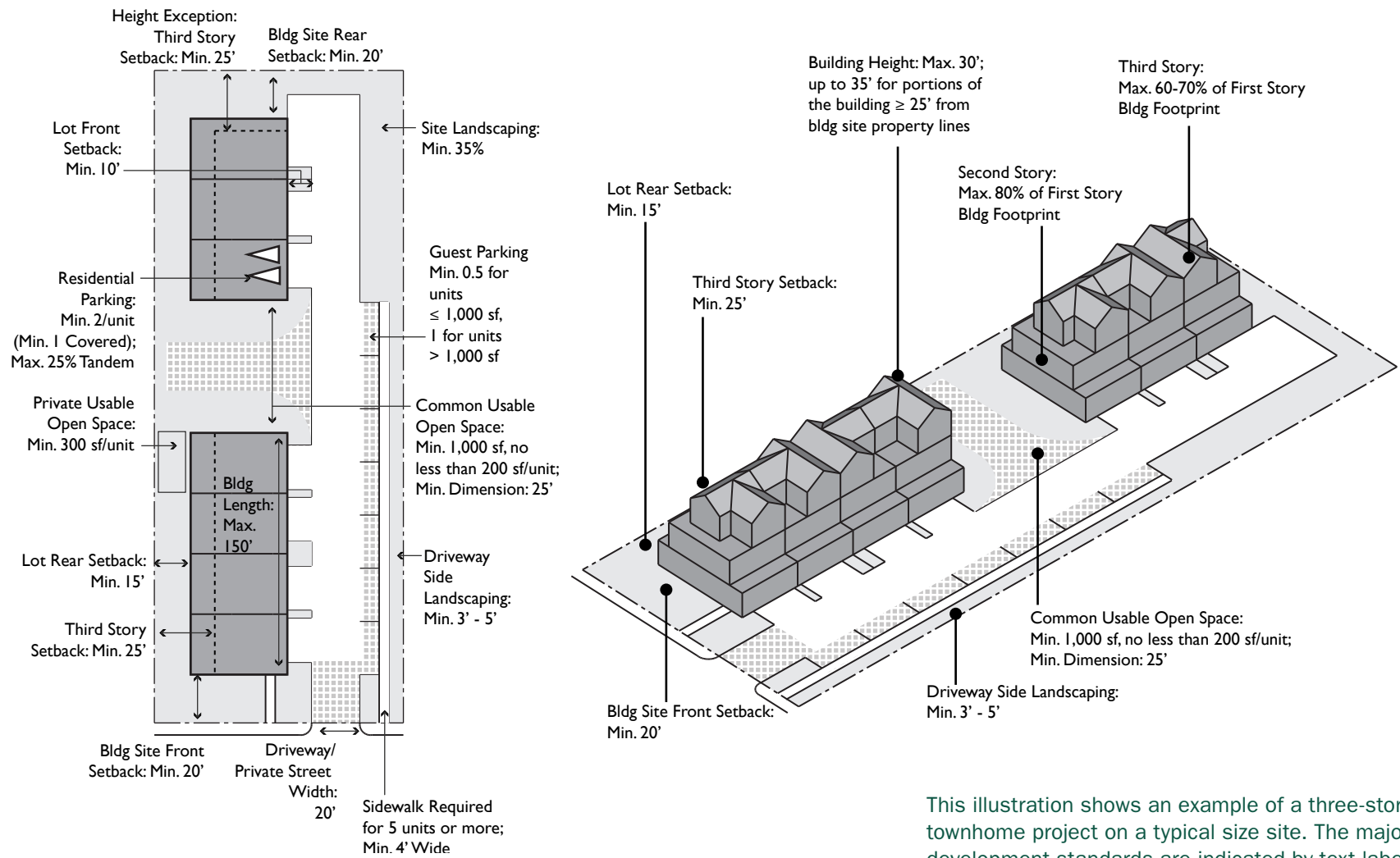
Note: Diagrams not to be used for density calculations.



This illustration shows an example of a two-story townhome project on a narrow site. The major development standards are indicated by text labels.

Figure 2.4-3: Three-Story Townhomes: Summary of Major Development Standards

Note: Diagrams not to be used for density calculations.



This illustration shows an example of a three-story townhome project on a typical size site. The major development standards are indicated by text labels. Deep sites may be required to provide a fire turnaround per Fire Department standards.

Figure 2.4-4: Townhomes: Height

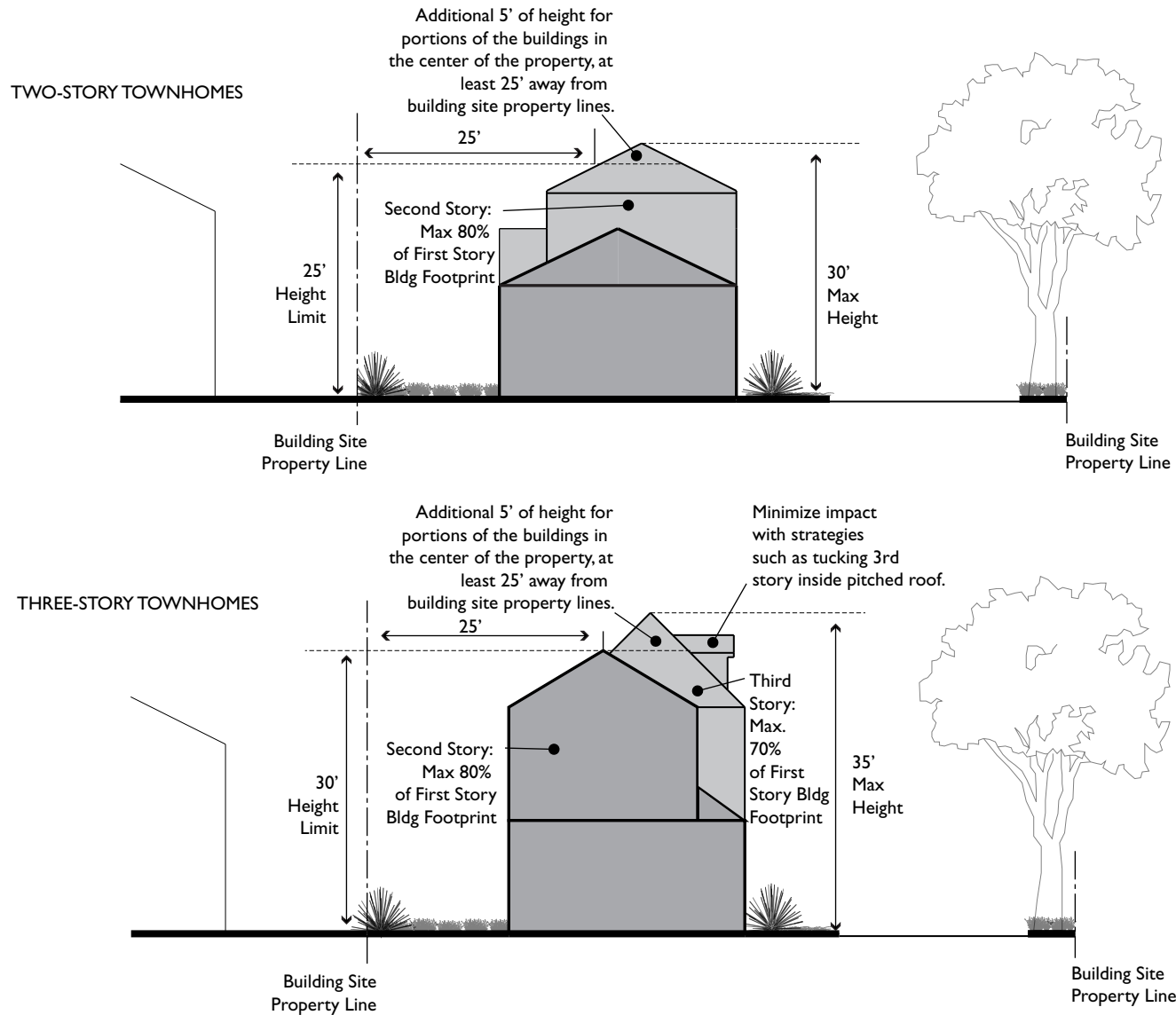


Figure 2.4-5: Townhomes: Garage Width



Figure 2.4-6: Townhomes: Garage Width Exception

Garage Width Exception:

Two-Story Townhomes:  
Maximum 70% of Facade Width

IF:

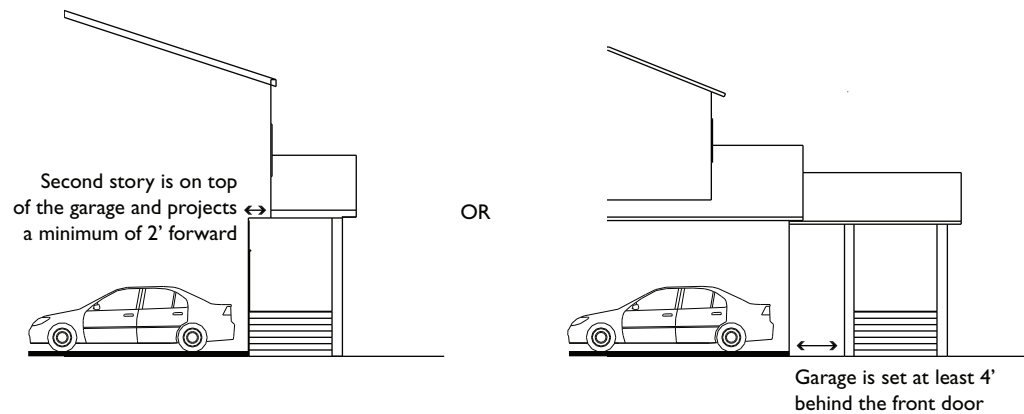


Figure 2.4-7: Townhome: Garage Width Exception for Three Stories



Garage Width Exception:

Three-Story Townhomes:  
Maximum 80% of Facade Width

IF:

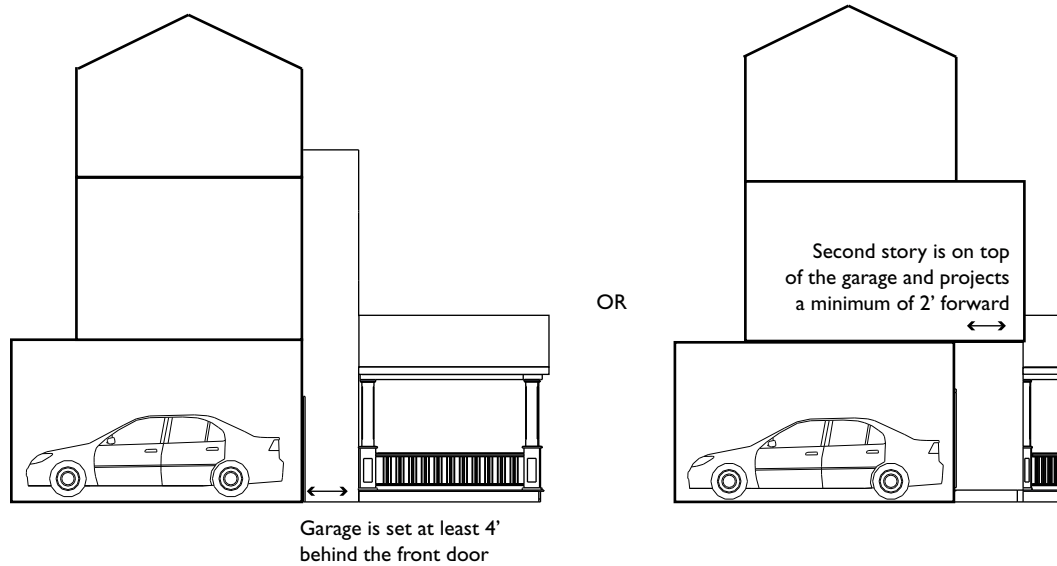


Figure 2.4-8: Townhomes: Side Yards

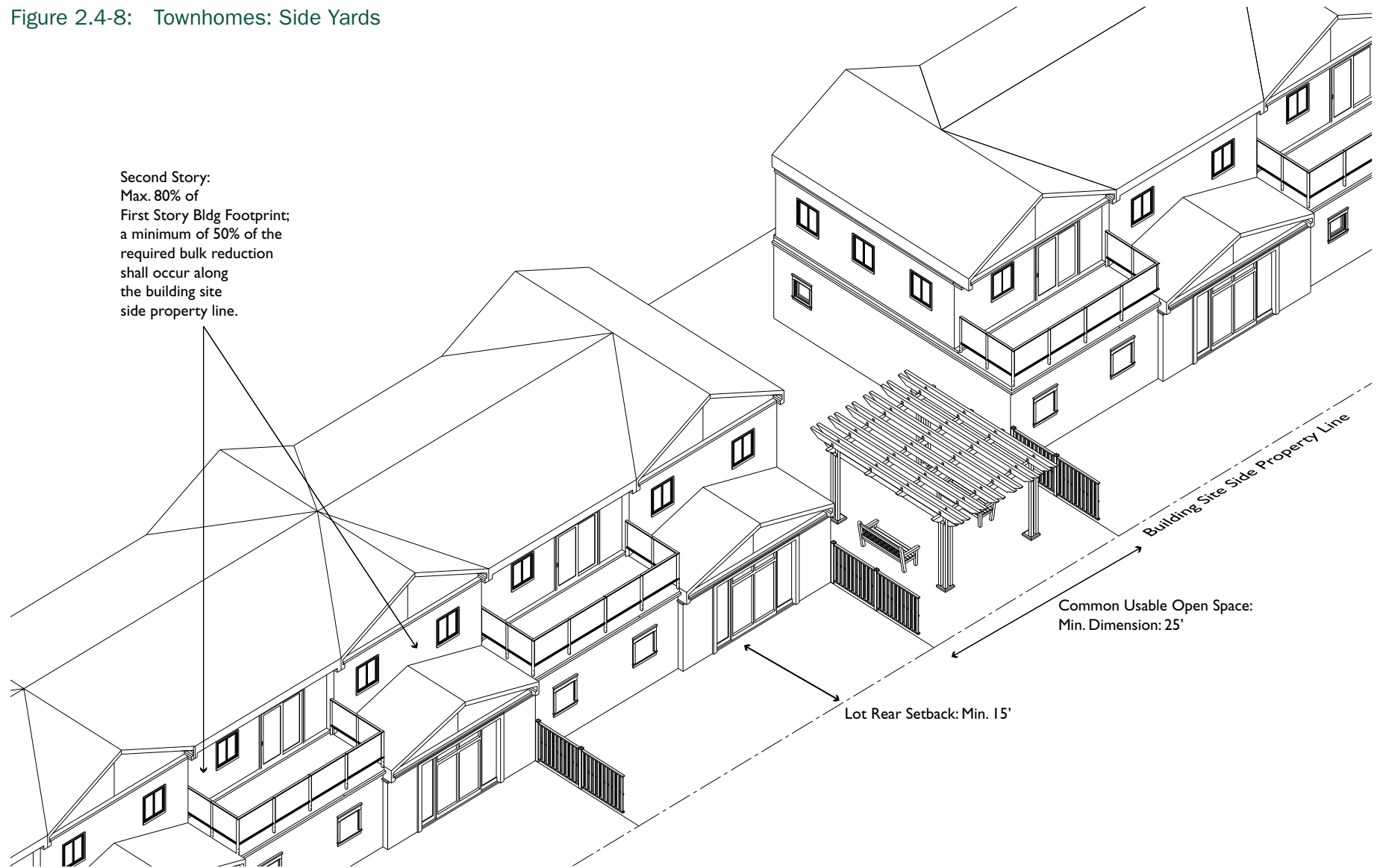




Figure 2.4-9: Townhomes: Open Space

Private Usable Open Space:  
Min. 100 sf/unit

Balcony Dimension: Min. 7'

Ground Floor Dimension: Min. 10'

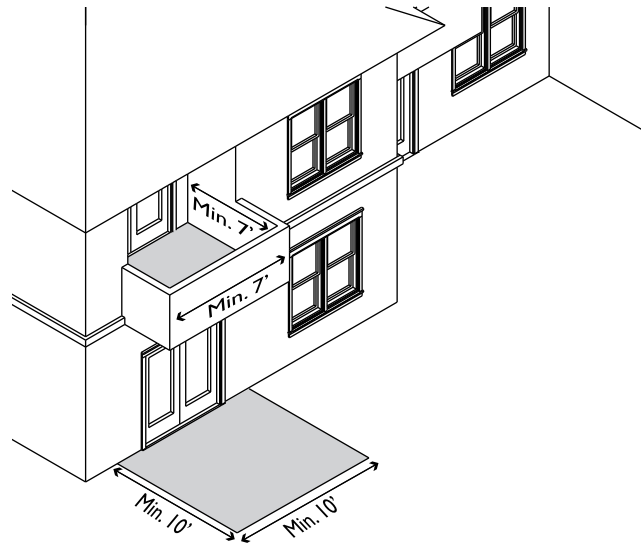


Figure 2.4-10: Townhomes: Front Yard Paving and Gates

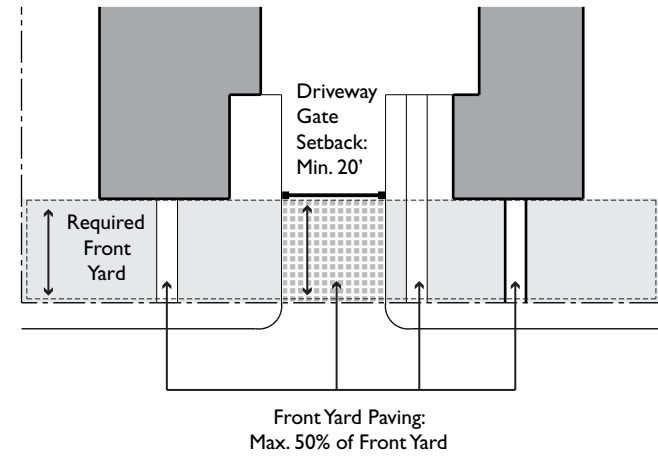


Figure 2.4-11: Townhomes: Front Porch or Covered Recess

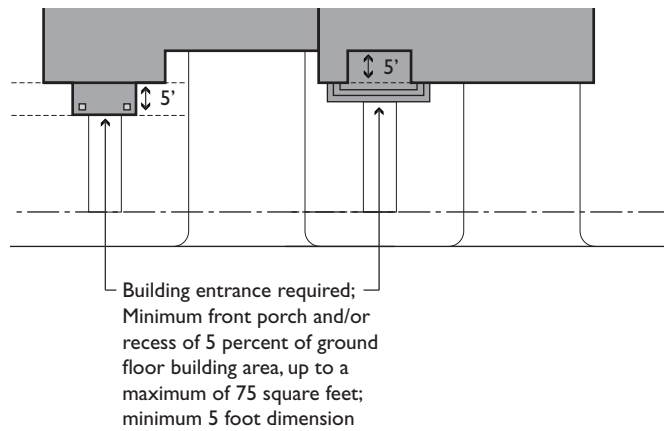
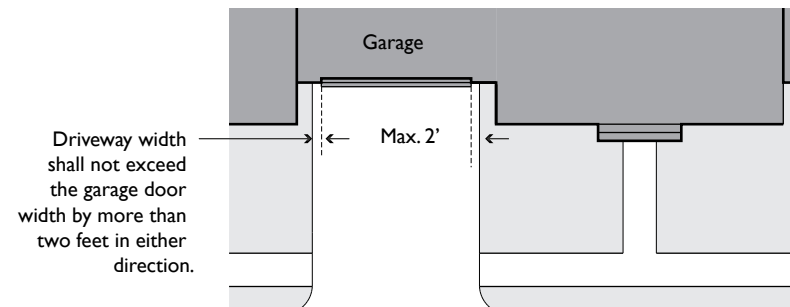


Figure 2.4-12: Townhomes: Driveway Aprons



*Page Intentionally Left Blank*

**TABLE 2.4-1: TOWNHOME STANDARDS**

<b>Standard</b>	<b>R-S-D35, R-S-DV, R-S-D25, R-2, R-S-D20, R-3, R-S-D3</b>	<b>Additional Standards</b>
<b>DEVELOPMENT INTENSITY AND NEIGHBORHOOD COMPATIBILITY</b>		
Minimum Building Site Size (sq ft)	5,000	
Minimum Area per Dwelling Unit (sq ft)		
R-S-D35, R-S-DV (with lot width < 100' and lot area < 20,000 sq ft)	3,500	Appropriate for two-story townhomes.
R-S-D3	3,000 - 2,000	Appropriate for two-story townhomes. Appropriate for three-story townhomes at minimum 2,000 square feet. Density is as specified in the zoning amendment creating the district.
R-S-D25, R-2	2,500	Appropriate for two-story or three-story townhomes.
R-S-D20, R-3, R-S-DV (with lot width ≥ 100' and lot area ≥ 20,000 sq ft)	2,000	Appropriate for three-story townhomes.
Minimum Building Site Width (ft)		
Two-Story Townhomes	65	
Three-Story Townhomes	75	
Minimum Lot Width (ft)	25	A minimum lot width of 30 to 40 feet may be necessary for two-story townhomes with double loaded attached garages in front, and to comply with Parking Location and Design requirements. Minimum lot width may be reduced to 20 feet if garages are single-car wide, detached and/or accessed from an alley.
<b>BUILDING HEIGHT AND FORM</b>		
Maximum Height (ft)		See Figure 2.4-4.
Two-Story Townhomes	25	
Two-Story Exception	30	Provided that roof is pitched and the portion of the roof over 25 feet in height is at least 25 feet away from building site property lines.
Three-Story Townhomes	30	

Table 2.4-1: Townhome Standards

<b>Standard</b>	<b>R-S-D35, R-S-DV, R-S-D25, R-2, R-S-D20, R-3, R-S-D3</b>	<b>Additional Standards</b>
Three-Story Exception	35	Provided that roof is pitched and the portion of the roof over 30 feet in height is at least 25 feet away from building site property lines.
Maximum Stories	2 - 3	
Maximum Floor Area (Percentage of First Story Building Footprint)		
Second Story (%)	80	The second story shall not exceed 80 percent of the first story building footprint area.
Third Story (%)	70	The third story shall not exceed 70 percent of the first story building footprint area.
Maximum Building Length (ft)	150	Exceptions may be approved by Staff if buildings are designed with many different setbacks (instead of a long flat wall), changes in roof form or height, and major recesses (notches) along the length of the building, which successfully break up the massing of the building.
<b>BUILDING RELATIONSHIP TO THE STREET</b>		
Maximum Front Yard Paving (%)	50	
Street Facing Façade Design	Required. Street facing facades must be designed to orient towards the public street, or private street if lot does not abut a public street. Windows, entry door, and other elements must be incorporated to create an attractive street appearance that is compatible with the surrounding neighborhood.	
Building Entrances on Streets	Required. The principal entry shall be located in a visible location facing the public street, or private street if lot does not abut a public street.	
Covered Front Porch or Covered Recessed Entry	Required	
Minimum Depth (ft)	5	Alternative designs that create a welcoming entry feature facing the street, such as a trellis or landscaped courtyard entry may be approved by Staff. See Figure 2.4-11.
Minimum Area of Porch or Recessed Area (sq ft)	5 percent of the first story building footprint area; up to a maximum of 75 square feet	
<b>SETBACKS FOR LIGHT, AIR, AND PRIVACY</b>		
Minimum Setbacks (ft)		Building setbacks apply along the perimeter of a building site and lot setbacks apply to individual lots within a building site. In the event of conflict between building setback requirements and lot setback requirements, the project must comply with whichever standard results in the greater setback.

Table 2.4-1: Townhome Standards

<b>Standard</b>	<b>R-S-D35, R-S-DV, R-S-D25, R-2, R-S-D20, R-3, R-S-D3</b>	<b>Additional Standards</b>
Building Site		
Front (Facing Public Street)	20	
Side (Facing Adjacent Neighboring Properties)	5	A minimum of 50 percent of the required bulk reduction shall occur along the building site side property line. If a building is within 5 feet of this property line, a minimum of 50 percent of the second story facade shall be stepped back a minimum of 5 feet from the first story facade and a minimum of half of that required amount shall occur along this side setback.
Side Exception	10	The building site side setback shall be a minimum of 10 feet if the project consists of three-story townhomes.
Rear (Facing Adjacent Neighboring Properties)	20	
Lot		
Front	10	
Side	5	Required setbacks apply to the ends of rows of attached single-unit dwellings.
Rear	15	
Minimum Distance Between Buildings (ft)		
Front to Front or Rear	40	Front is considered any wall with windows into the primary living area of the unit.
Rear to Rear	30	
Side to Front or Rear	20	If windows are clear and eye-level, they must be offset by at least 5 feet.
Side to Side	10	If windows are clear and eye level, they must be offset by at least 5 feet.
Minimum Setback From Access Driveway (ft)		
Setback From Access Driveway Exception (ft)	7.5	The minimum setback from access driveway shall be 7.5 feet if building site width is less than 70 feet and greater than or equal to 6 feet; Must be landscaped.

Table 2.4-1: Townhome Standards

<b>Standard</b>	<b>R-S-D35, R-S-DV, R-S-D25, R-2, R-S-D20, R-3, R-S-D3</b>	<b>Additional Standards</b>
<b>AUTO CIRCULATION: SITE ACCESS AND DRIVEWAYS</b>		
Minimum Access Driveway/Private Street Width (ft)	20	
Minimum Access Driveway/Private Street Width Exception	12	Minimum 12' if lots are narrow and driveways serve fewer than 5 units. Fire Department may consider this exception if the rear-most corner of the rear-most building is within 150' of the curb and alternative means and methods are incorporated to meet Fire Code safety objectives.
Maximum Curb Cuts (number per building site)	1	Exception may be granted by Staff if building site exceeds one acre, building site frontage exceeds 200 feet, or through lot.
Minimum Driveway Gates Setback (ft)	20	Gates across driveways shall be set back a minimum of 20 feet behind the property line, or greater depending on location in State Responsibility Fire Area and street travel speed.
<b>PARKING LOCATION AND DESIGN</b>		
Maximum Garage Width (ft)	20	
Facing Public Street (%)	Where garage doors face a public street, garage width shall not exceed 50 percent of the width of the front facade of the building unit.	
Facing Access Driveway/Private Street (%)	Where garage doors face a private street or access driveway, garage width for two-story townhomes shall not exceed 60 percent and three-story townhomes shall not exceed 70 percent of the width of the front facade of the building unit.	
Facing Access Driveway/Private Street Exception (%)	Where garage doors face a private street or access driveway, garage width for two-story townhomes shall not exceed 70 percent and three-story townhomes shall not exceed 80 percent of the width of the front facade of the building if the garage (wall to wall) is set at least four feet behind the front door or a second story above the garage projects at least two feet forward in front of the garage.	
Maximum Driveway Apron Width (ft)	Driveway apron widths shall not exceed the garage door width by more than one foot in either direction. See Figure 2.4-12.	
Unit Parking (space per unit)	2	Minimum of one space must be covered. Tandem parking allowed for up to 25 percent of the units.
Guest Parking (space per unit)	Space along the public street frontage of a building site can be counted towards guest parking requirements. However, guest spaces may be required to be on the building site if there is existing parking congestion, as defined by the Planning Director, on the street. A parking study may be required to determine existing parking congestion. Driveway aprons may be counted for the required guest parking.	
Units ≤ 1,000 sq ft		
Units > 1,000 sq ft	1	

Table 2.4-1: Townhome Standards

<b>Standard</b>	<b>R-S-D35, R-S-DV, R-S-D25, R-2, R-S-D20, R-3, R-S-D3</b>	<b>Additional Standards</b>
<b>FACILITIES FOR PEDESTRIANS, BICYCLES, AND TRANSIT</b>		
Minimum Decorative Driveway Paving (% of Driveway and Parking Area)	10	Locate at driveway entrance, driveway aprons and in areas that can be used as open space.
Minimum Decorative Driveway Paving Exception (% of Driveway and Parking Area)	25	Required if there is no pedestrian walkway/sidewalk provided along the access driveway/private street. A minimum 4 foot wide walkway consisting of decorative paving should also be provided.
Pedestrian Walkway Next to Driveway/Private Street	Required for 5 units or more.	Staff may approve exception for building sites with width less than 80 feet, provided that the percentage of minimum decorative driveway paving exception is met.
Minimum Width of Pedestrian Walkway (ft)	4	
<b>SITE LANDSCAPING</b>		
Minimum Site Landscaping (%)	35	
Minimum Width of Landscaped Buffer between Pedestrian Walkway and Access Driveway/Private Street (ft)	3	
Minimum Width of Landscaping for Driveway/Private Street/Parking Area (ft)	5	Applies between the access driveway/private street/parking areas and the side and rear property lines.
Minimum Side Landscaping Exception (ft)	3	The minimum width of driveway side landscaping shall be 3 feet when building site width is less than 75 feet.
<b>USABLE OPEN SPACE</b>		
Minimum Total Usable Open Space (sq ft per unit)	600	Common usable open space is not required for projects with four units or fewer provided that each townhome unit has a minimum of 300 square feet of private open space.
Minimum Common Usable Open Space (sq ft)	1,000 square feet; no less than 200 square feet per unit	Common open space buildings or covered structures cannot occupy more than 20 percent of common open space.
Minimum Dimension (ft)	25	
Minimum Private Usable Open Space (sq ft)	300	Private open space must be open air, not fully enclosed with walls. Private open space cannot be covered by a roof by more than 50 percent of the area; however balconies can have up to 100 percent ceiling coverage.
Minimum Ground Floor Dimension (ft)	10	See Figure 2.4-9.
Minimum Balcony Dimension (ft)	7	

*Page Intentionally Left Blank*



## 2.5 Multi-Family Residential Standards

This section presents the development standards for multi-family residential projects, including both apartments and condominiums.

The purpose of the multi-family residential standards is to allow for a variety of housing types in the unincorporated areas of Alameda County that serve all types of households, while also achieving neighborhood goals for an attractive street appearance, and minimizing impacts on neighboring properties. The standards are also to ensure a quality living environment that will be desirable and hold its value over time. When apartment and condominium projects are well designed, they can provide good quality housing and be a great contributor to neighborhoods.

Multi-family residential development is a multi-story building which has a shared entry lobby, and common access areas such as hallways or stairways that lead to individual units. Parking is often shared, whether in a garage or parking court.

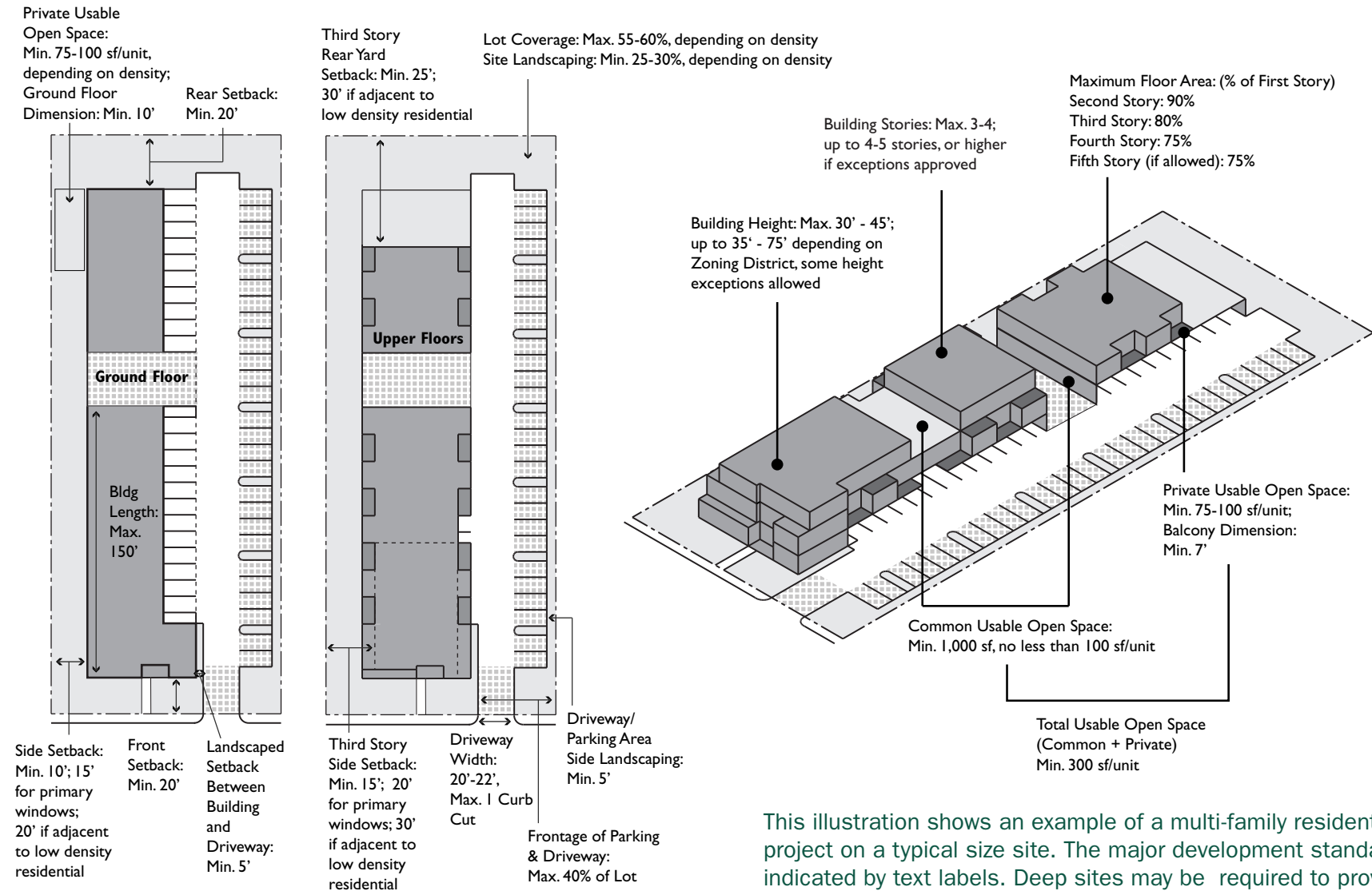
Medium density multi-family residential development requires a minimum of 1,500 to 2,500 square feet per dwelling unit. High density multi-family residential development requires a minimum of 1,250 to 1,000 square feet per dwelling unit. Densities may be higher in some areas of the Castro Valley Central Business District and the Ashland Cherryland Business District if certain standards are met.

Medium density multi-family residential development is appropriate in the R-S-D20, R-3, R-S-DV, R-S-D15, and R-S-D3 zones, which are located in parts of Ashland and Castro Valley, and for larger projects sites in Hayward Acres and south Cherryland. Medium density multi-family residential is appropriate in Subareas 4, 5, 6, 7 and 11 in the Castro Valley Central Business District Specific Plan area, with some limitations. (See Table 2.1-1) It is also appropriate in the Residential Commercial (R/C) designation in the Ashland Cherryland Specific Plan area, along Lewelling Boulevard.

High density multi-family residential development is appropriate in the R-4 zone, a limited zoning designation in Ashland and Cherryland. It is also appropriate in Subareas 8 and 9 in the Castro Valley Central Business District Specific Plan Area, with some limitations. (See Table 2.1-1)



Figure 2.5-1: Multi-Family Residential: Summary of Major Development Standards  
 For illustrative purposes only; see Table 2.5-1 for details.



This illustration shows an example of a multi-family residential project on a typical size site. The major development standards are indicated by text labels. Deep sites may be required to provide a fire turnaround per Fire Department standards.

Figure 2.5-2: Multi-Family Residential Project  
For illustrative purposes only; see Table 2.5-1 for details.

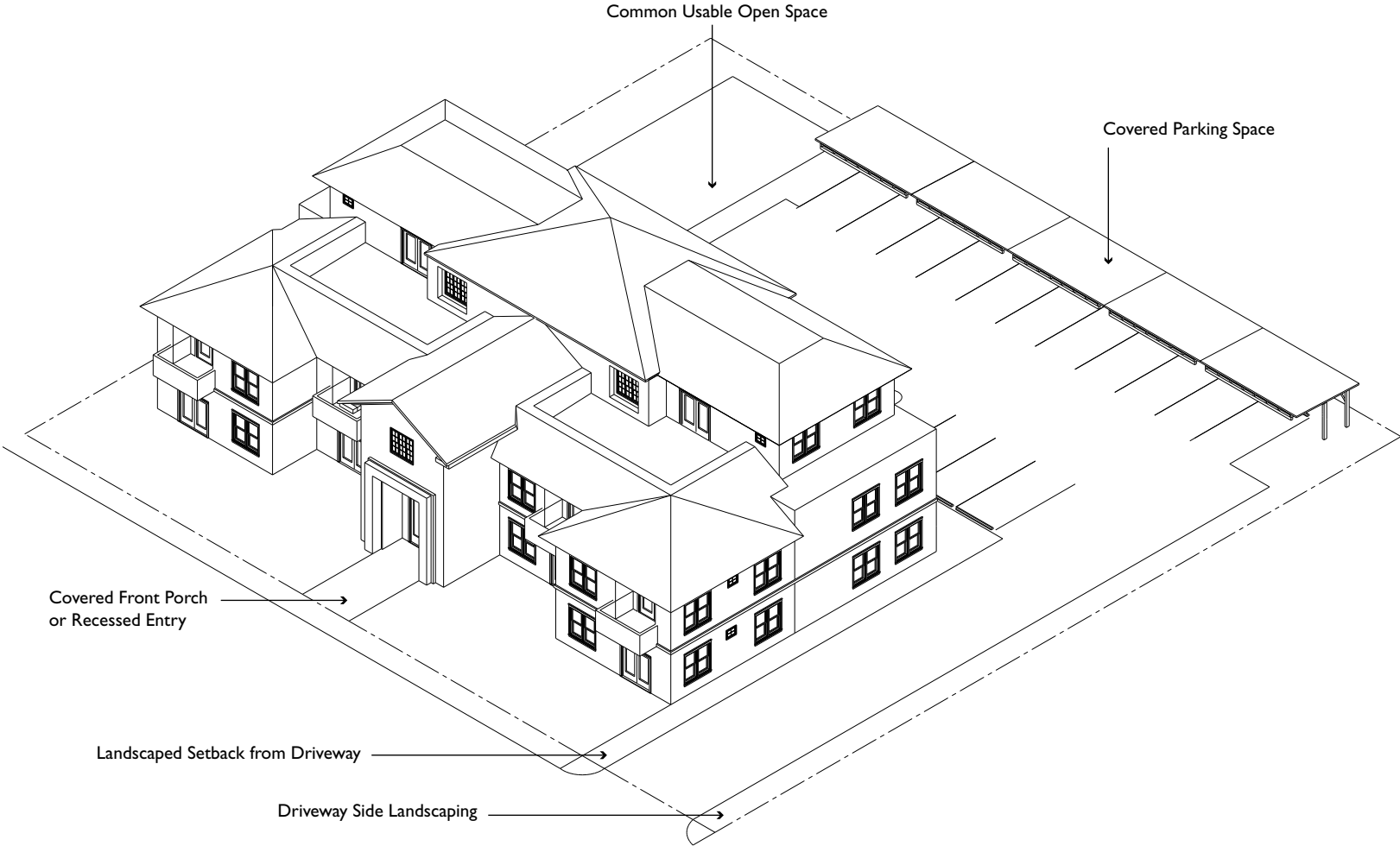


Figure 2.5-3: Multi-Family Residential: Elevation



Figure 2.5-4: Multi-Family Residential: Front Yard Paving

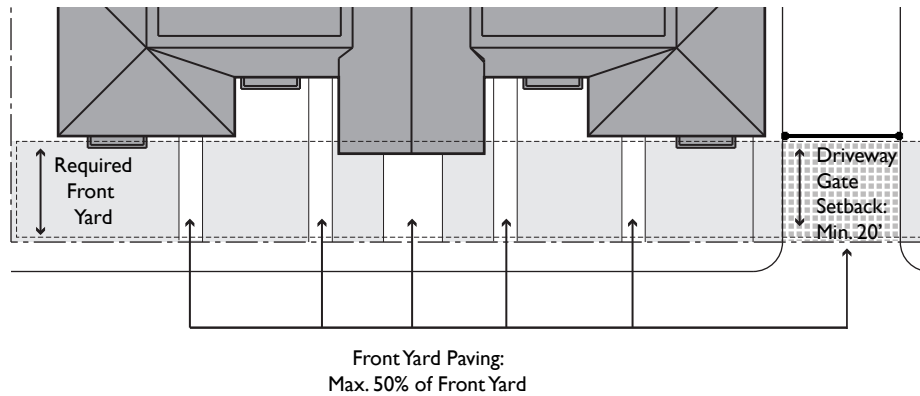
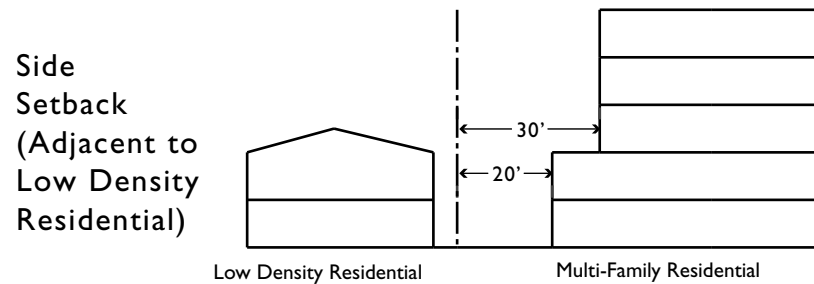
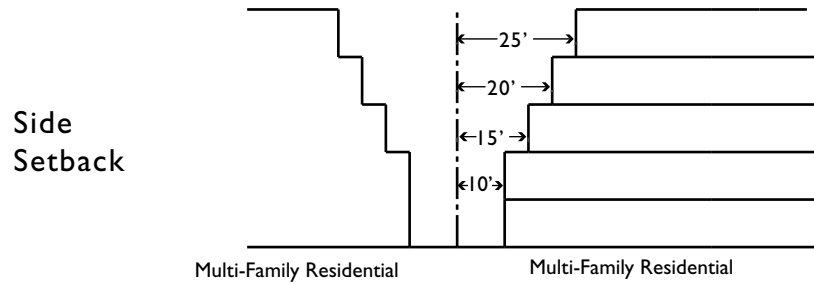


Figure 2.5-5: Multi-Family Residential: Side and Rear Setbacks

### SIDE SETBACK



### REAR SETBACK

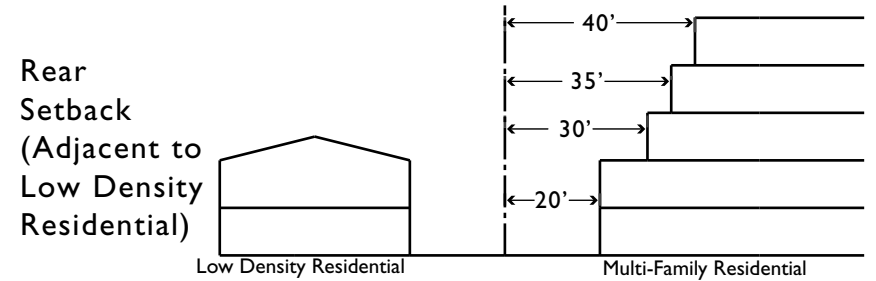
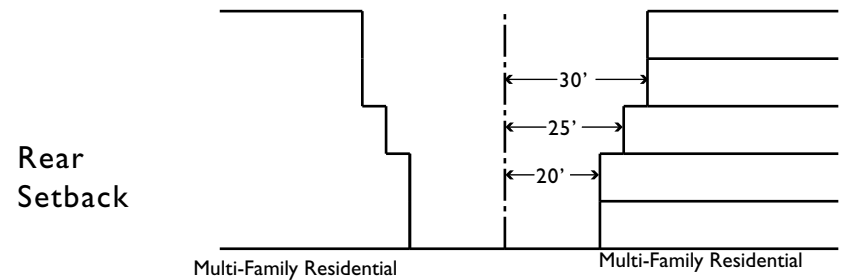
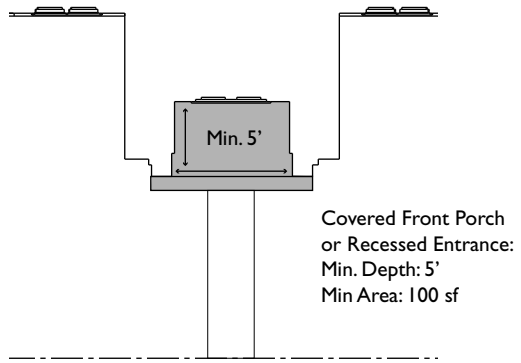


Figure 2.5-6: Multi-Family Residential: Primary Entrance



Private Usable Open Space:  
Min. 75-100 sf/unit

Balcony Dimension: Min. 6' - 7',  
depending on density

Ground Floor Dimension: Min. 10'

Figure 2.5-7: Multi-Family Residential: Open Space

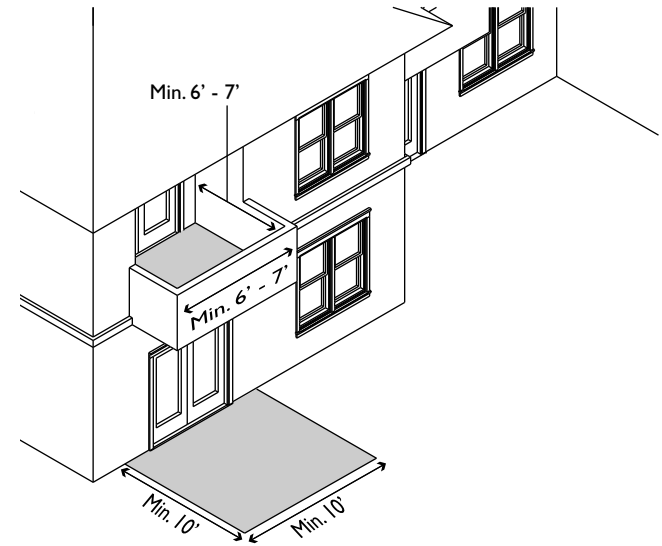


Figure 2.5-8: Multi-Family Residential:  
Front Setback and Elevation above Sidewalk

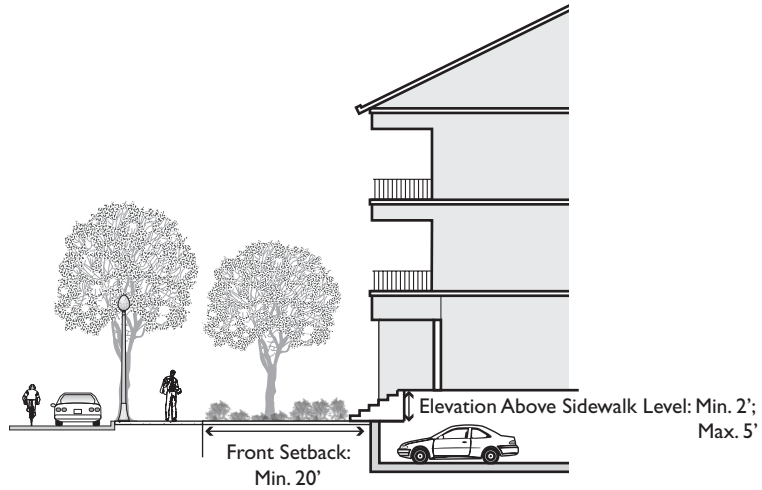


Figure 2.5-9: Multi-Family Residential:  
Height Projections

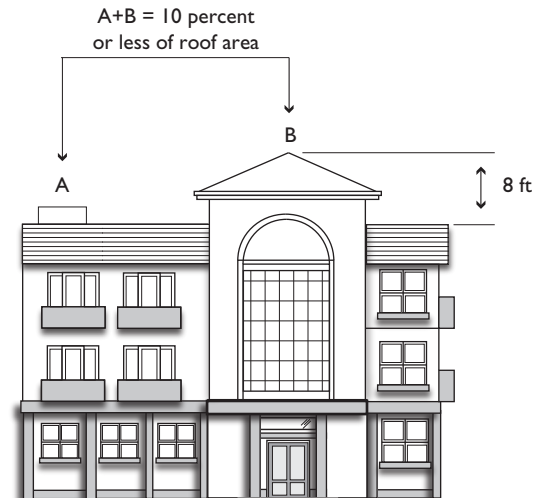
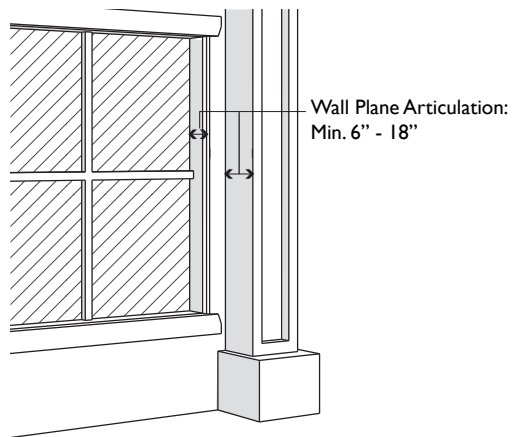


Figure 2.5-10: Multi-Family Residential:  
Ground Floor Articulation



*Page Intentionally Left Blank*



**Table 2.5-1: Multi-Family Residential Standards**

ACBD: Ashland and Cherryland Business District / CVCBD: Castro Valley Central Business District								
<b>Standard</b>	<b>Medium Density Residential</b>					<b>High Density Residential</b>		<b>Additional Standards</b>
	R-3, R-S-D20	R-S-D15, R-S-D3	R-S-DV (with lot width ≥ 100', lot area ≥ 20,000 sq ft), R-S-D3	ACBD-RC	CVCBD Land Use Group D (Subarea 4,5,6,7,11) <sup>1</sup>	CVCBD Land Use Group E (Subarea 8, 9)	R-4	
<b>DEVELOPMENT INTENSITY AND NEIGHBORHOOD COMPATIBILITY</b>								
Minimum Building Site (sq ft)	5,000	5,000	20,000		10,000 - 20,000	20,000	6,000	
Minimum Lot Width (ft)	100	100	100	100	100	100	100	
Minimum Lot Frontage (ft)						100	100	
Maximum Density (dwelling units/net acre)	21.8	29	21.8	15 - 25	17.4 - 21.8; 20 - 40	40 - 60	34.5 - 43.5	For CVCBD Land Use Group D, 20-40 du/ac is allowed in special circumstances. See Multi-Family Residential, CVCBD Land Use Group D in Table 2.1.
Minimum Area per Dwelling Unit (sq ft)	2,000	1,500	2,000		2,500 - 2,000		1,250 - 1,000	For CVCBD, Land Use Group D: 2,500 with minimum lot size of 10,000 – 20,000 square feet 2,000 with minimum lot size of > 20,000 square feet See also Multi-Family Residential, CVCBD Land Use Group D in Table 2.1. For R-S-D3: As specified in the zoning amendment creating the district, in no case less than 1,500 square feet.
Maximum Lot Coverage (%)	55	55	55	55	55	60	60	
<b>BUILDING HEIGHT AND FORM</b>								
Maximum Height (ft)	30	30	30	35	45	45	45	In CVCBD, all buildings with heights greater than two stories or thirty feet must demonstrate through the Site Development Review process that they frame or complement, rather than block, view corridors and that they enhance, rather than obscure, significant topographic features or adjacent development.

Table 2.5-1: Multi-Family Residential Standards

ACBD: Ashland and Cherryland Business District / CVCBD: Castro Valley Central Business District								
<b>Standard</b>	<b>Medium Density Residential</b>					<b>High Density Residential</b>		<b>Additional Standards</b>
	R-3, R-S-D20	R-S-D15, R-S-D3	R-S-DV (with lot width ≥ 100', lot area ≥ 20,000 sq ft), R-S-D3	ACBD-RC	CVCBD Land Use Group D (Subarea 4,5,6,7,11) <sup>1</sup>	CVCBD Land Use Group E (Subarea 8, 9)	R-4	
Height Exception	35	35	35	–	–	55	75	Provided that the portion of the roof over the maximum height allowed is at least 25 feet away from property lines and if the site is not adjacent to R-1 or other low density residential district.  For R-4 District, maximum height of 75 feet only if lot coverage does not exceed 30 percent.
Height Exception (For Projections)	Non-habitable building features such as chimneys (up to 6 feet in width), cupolas, flagpoles, monuments, steeples, roof screens, equipment, and similar structures, covering no more than 10 percent of the top floor roof area to which they are accessory, may exceed maximum permitted height standards by 8 feet.							
Maximum Stories	3	3	3	3	3	4	–	
Stories Exception	–	–	–	–	4	5	–	
Maximum Floor Area (%) (Percentage of First Story Building Footprint Area)	First Story: 100% Second Story: 90% Third Story: 80% Fourth Story (if allowed): 75% Fifth Story (if allowed): 75%							
Maximum Building Length (ft)	150	150	150	150	150	150	150	Exceptions may be approved by Staff if buildings are designed with many different setbacks (instead of a long flat wall), changes in roof form or height, and major recesses (notches) along the length of the building, which successfully break up the massing of the building. Parking podiums may be continuous.
<b>BUILDING RELATIONSHIP TO THE STREET</b>								
Maximum Front Yard Paving (%)	50	50	50	50	50	50	50	
Street Facing Façade Design	Required. Street facing facades must be designed to orient towards the public street. Windows, entry door, and other elements must be incorporated to create an attractive street appearance that is compatible with the surrounding neighborhood.							

Table 2.5-1: Multi-Family Residential Standards

ACBD: Ashland and Cherryland Business District / CVCBD: Castro Valley Central Business District								
<b>Standard</b>	<b>Medium Density Residential</b>					<b>High Density Residential</b>		<b>Additional Standards</b>
	R-3, R-S-D20	R-S-D15, R-S-D3	R-S-DV (with lot width ≥ 100', lot area ≥ 20,000 sq ft), R-S-D3	ACBD-RC	CVCBD Land Use Group D (Subarea 4,5,6,7,11) <sup>1</sup>	CVCBD Land Use Group E (Subarea 8, 9)	R-4	
Building Entrances on Public Street	Required. The principal entry, in the form of individual entrances or aggregated building entrances, shall be located in a visible location facing the public street.							
Principal Entry Projection and/or Recess	Required. The principal entry shall incorporate a projection or recess, or combination of projection and recess.							
Minimum Depth (ft)	5	5	5	5	5	5	5	Alternative designs that create a welcoming entry feature facing the street, such as a trellis or landscaped courtyard entry may be approved by Staff.
Minimum Area of Projection and/or Recess (sq ft)	100	100	100	100	100	100	100	See Figure 2.5-6.
Exception	If entries consist of individual entrances, each individual entrance shall incorporate a projection (e.g. porch) or recess, or combination of projection and recess at least 40 square feet in area, with a minimum depth of five feet.							
<b>GROUND FLOOR BUILDING DESIGN</b>								
Minimum Wall Plane Articulation	Ground floor wall plane articulation shall be a minimum of 6 to 18 inches. Windows, doors, columns, and other features should be recessed or project forward, such that there is a six-inch difference between wall and window surfaces and a total of at least 18 inches from the window to the outermost plane of a wall or column. See Figure 2.5-11.							
Elevation Above Sidewalk Level (ft)								Applies to ground floor living space. See Figure 2.5-8.
Minimum	2	2	2	2	2	2	2	
Maximum	5	5	5	5	5	5	5	
<b>SETBACKS FOR LIGHT, AIR, AND PRIVACY</b>								
Minimum Setbacks (ft)								See Figure 2.5-5.
Front Setback	20	20	20	20	20	20	20	

Table 2.5-1: Multi-Family Residential Standards

ACBD: Ashland and Cherryland Business District / CVCBD: Castro Valley Central Business District								
<b>Standard</b>	<b>Medium Density Residential</b>					<b>High Density Residential</b>		<b>Additional Standards</b>
	R-3, R-S-D20	R-S-D15, R-S-D3	R-S-DV (with lot width ≥ 100', lot area ≥ 20,000 sq ft), R-S-D3	ACBD-RC	CVCBD Land Use Group D (Subarea 4,5,6,7,11) <sup>1</sup>	CVCBD Land Use Group E (Subarea 8, 9)	R-4	
Side	First Story: 10 Second Story: 10 Third Story: 15 Fourth Story (if allowed): 20 Fifth Story (if allowed): 25					10' + 1' for each full 10' by which the median lot width exceeds 50', up to 30'		
Side (For Walls Containing Living Room or Other Primary Room Windows)	First Story: 15 Second Story: 15 Third Story: 20 Fourth Story (if allowed): 25 Fifth Story (if allowed): 30							These setbacks shall apply for any wall containing living room or other primary room windows. When the site is adjacent to a R-1 or R-S district, the project must comply with whichever standard results in the greater setback.
Side (Adjacent to R-1 or R-S District)	First Story: 20 Second Story: 20 Third Story: 30 Fourth Story (if allowed): 30 Fifth Story (if allowed): 30							
Rear	First Story: 20 Second Story: 20 Third Story: 25 Fourth Story (if allowed): 30 Fifth Story (if allowed): 30					10' + 3' for every full 10' by which bldg height exceeds 35'		

Table 2.5-1: Multi-Family Residential Standards

ACBD: Ashland and Cherryland Business District / CVCBD: Castro Valley Central Business District								
<b>Standard</b>	<b>Medium Density Residential</b>					<b>High Density Residential</b>		<b>Additional Standards</b>
	R-3, R-S-D20	R-S-D15, R-S-D3	R-S-DV (with lot width ≥ 100', lot area ≥ 20,000 sq ft), R-S-D3	ACBD-RC	CVCBD Land Use Group D (Subarea 4,5,6,7,11) <sup>1</sup>	CVCBD Land Use Group E (Subarea 8, 9)	R-4	
Minimum Setback From Access Driveway (ft)	5	5	5	5	5	5	5	Must be landscaped.
Minimum Distance Between Buildings (ft)	The minimum distance between buildings shall be 10 feet. The minimum distance shall be increased by 10 feet for each additional story.							
<b>AUTO CIRCULATION: SITE ACCESS AND DRIVEWAYS</b>								
Maximum Access Driveway Width (ft)	20	20	20	20	20	20	20	Staff may approve up to 25 feet for higher density development on busy streets.
Maximum Curb Cuts (number per lot)	1	1	1	1	1	1	1	Exception may be granted by Staff if lot exceeds one acre, lot frontage exceeds 200 feet, or through lot.
Minimum Spacing Between Curb Cuts (ft)				50				
Minimum Driveway Gates Setback (ft)	20	20	20	20	20	20	20	Gates are strongly discouraged. Gates across driveways shall be set back a minimum of 20 feet behind the property line, or greater depending on location in State Responsibility Fire Area and street travel speed.
<b>PARKING LOCATION AND DESIGN</b>								
Maximum Frontage of Parking and Driveways (% of lot frontage)	40	40	40	40	40	40	40	
Maximum Frontage of Parking (% of lot frontage)	30	30	30	30	30	30	30	
Unit Parking (space per unit)	Studio: 1; One Bedroom: 1.5 Two Bedrooms or More: 2							Minimum of one space must be covered. Tandem parking allowed for up to 25 percent of the units.  For CVCBD, lots consisting of more than eight spaces must provide at least 25 percent but not more than 50 percent compact spaces.

Table 2.5-1: Multi-Family Residential Standards

ACBD: Ashland and Cherryland Business District / CVCBD: Castro Valley Central Business District								
<b>Standard</b>	<b>Medium Density Residential</b>					<b>High Density Residential</b>		<b>Additional Standards</b>
	R-3, R-S-D20	R-S-D15, R-S-D3	R-S-DV (with lot width ≥ 100', lot area ≥ 20,000 sq ft), R-S-D3	ACBD-RC	CVCBD Land Use Group D (Subarea 4,5,6,7,11) <sup>1</sup>	CVCBD Land Use Group E (Subarea 8, 9)	R-4	
Transit Corridor Exception	Allow reduced parking for projects that are ½ mile from transit stations of ¼ mile from major transit corridors, through a discretionary review process that includes public notice and opportunity for public input. Transit stations are defined as a BART station, light rail station, or other heavy rail transit station. Major transit corridors are defined as bus corridors with bus rapid transit or corridors with bus service at least every 15 minutes during peak hours and every 30 minutes during daytime hours. Parking reduction may be not allowed if there is existing parking congestion, as defined by the Planning Director, on the street. A parking study may be required to determine existing parking congestion.							
Guest Parking (space per unit)	0.5	0.5	0.5	0.5	0.5	0.5	0.5	
<b>FACILITIES FOR PEDESTRIANS, BICYCLES AND TRANSIT</b>								
Minimum Decorative Driveway Paving (% of Driveway and Parking Area)	10							Locate at driveway entrance, parking areas, and in areas that can be used as open space.
Bicycle Parking	Required. See Chapter 6: Bicycle Parking Standards							
Transit Shelters	On sites that abut a transit corridor (with bus service at least every 15 minutes during peak hours and every 20 - 30 minutes during daytime hours), as requested by the transit agency.							
Public Right-of-Way Improvements	See Specific Plans and Alameda County Engineering Guidelines							
<b>SITE LANDSCAPING</b>								
Minimum Site Landscaping (%)	30	30	30	30	30	25	25	
Minimum Width of Driveway Side Landscaping (ft)	5	5	5	5	5	5	5	Applies between the access driveway and the side and rear property lines.

Table 2.5-1: Multi-Family Residential Standards

ACBD: Ashland and Cherryland Business District / CVCBD: Castro Valley Central Business District								
<b>Standard</b>	<b>Medium Density Residential</b>					<b>High Density Residential</b>		<b>Additional Standards</b>
	R-3, R-S-D20	R-S-D15, R-S-D3	R-S-DV (with lot width ≥ 100', lot area ≥ 20,000 sq ft), R-S-D3	ACBD-RC	CVCBD Land Use Group D (Subarea 4,5,6,7,11) <sup>1</sup>	CVCBD Land Use Group E (Subarea 8, 9)	R-4	
Minimum Parking Area Landscaping	See Chapter 6: Parking Area Landscaping Standards							
<b>USABLE OPEN SPACE</b>								
Minimum Total Usable Open Space (sq ft per unit)	350	350	350	350	300	300	300	
Minimum Common Usable Open Space (sq ft)	1,000 square feet, no less than 100 square feet per unit							Required for projects with five or more units. Common space buildings or covered structures cannot occupy more than 20 percent of common open space.
Minimum Dimension (ft)	25	25	25	25	25	25	25	
Minimum Private Usable Open Space (sq ft)	100	100	100	100	75	75	75	Up to 20 percent of units may not be required to provide private usable open space if they are close to common usable open space and the common usable open space exceeds the minimum required.  Private open space must be open air, not fully enclosed with walls. Private open space cannot be covered by a roof by more than 50 percent of the area; however balconies can have up to 100 percent ceiling coverage.  See Figure 2.5-8.
Minimum Ground Floor Dimension (ft)	10	10	10	10	10	10	10	
Minimum Balcony Dimension (ft)	7	7	7	7	7	6	6	

Table 2.5-1: Multi-Family Residential Standards

ACBD: Ashland and Cherryland Business District / CVCBD: Castro Valley Central Business District								
Standard	Medium Density Residential					High Density Residential		Additional Standards
	R-3, R-S-D20	R-S-D15, R-S-D3	R-S-DV (with lot width ≥ 100', lot area ≥ 20,000 sq ft), R-S-D3	ACBD-RC	CVCBD Land Use Group D (Subarea 4,5,6,7,11) <sup>1</sup>	CVCBD Land Use Group E (Subarea 8, 9)	R-4	
STORAGE								
Storage Areas	Required for all units.							
Minimum Area (cubic ft per unit)	100 cu ft, plus 75 cu ft per bedroom with maximum 250 cu ft total required							
Minimum Dimension (ft)	8	8	8	8	8	8	8	
<p>Notes: Castro Valley Central Business District Subarea 11:</p> <p><sup>1</sup>. Medium density residential uses, subject to the provisions of Land Use Group D (High Density Residential) are allowed on properties along Redwood Court, Wilbeam Avenue, Chester Street, Rutledge Road, and Baker Road within 760 feet of Castro Valley Boulevard, which were formerly zoned in an R-3 (Four Family Residence), R-4 (Multiple Residence) District, the various R-S (Suburban Residence) Districts, or a PD (Planned Development) District based on the R-S District, or classified in Land Use Group E (High Density Residential) by the 1983 Plan. In addition, Land Use Group D development is allowed throughout the subarea where all the following conditions are met:</p> <ul style="list-style-type: none"> <li>– The property proposed for development is contiguous for least seventy-five percent (75%) of at least one continuous major property line (which represents at least twenty-five percent (25%) of the total circumference of the property), not including the street frontage, to existing medium density residential or commercial development or the BART station, OR has at least two adjacent street frontages (i.e. be a corner lot) and is contiguous as indicated above or adjacent across the street (not diagonally) to high density residential or commercial development or the BART station; and</li> <li>– The property proposed for development is a regularly shaped parcel (generally rectangular, with a low width:depth ratio, generally 1:2 or lower) at least 20,000 square feet in area, and does not leave an isolated parcel which cannot meet these requirements; and</li> <li>– It has been determined on the basis of an initial study that there will be no adverse impacts on surrounding development, including but not limited to traffic, visual, noise, privacy, or others, or that such impacts can be mitigated to an acceptable level and such mitigation measures are incorporated into the project through a mitigated negative declaration or environmental impact report. (Castro Valley Business District Specific Plan, p. 70-71)</li> </ul>								



# 3

# DESIGN GUIDELINES FOR RESIDENTIAL PROJECTS

The Residential Guidelines provide specific and broad recommendations to create high quality buildings and site plans that will result in more attractive, livable, and pedestrian-friendly neighborhoods. They aim to be prescriptive enough to create a framework for design and carry out the community's urban design vision but flexible enough to allow for creativity and innovation in design and planning. This Chapter presents Design Guidelines on the following topics:

- A. Development Intensity and Neighborhood Compatibility
- B. Building Height and Form
- C. Building Relationship to the Street
- D. Building Design
- E. Building Setbacks for Light, Air and Privacy
- F. Auto Circulation: Site Access, Streets and Driveways
- G. Parking Location and Design
- H. Facilities for Walking, Bicycle, Transit
- I. Site Landscaping
- J. Usable Open Space
- K. Fences and Walls
- L. Services

## A. DEVELOPMENT INTENSITY AND NEIGHBORHOOD COMPATIBILITY

These guidelines ensure that projects do not visually disrupt the existing neighborhood character or degrade the environment and living experience of neighbors.

- A-1 Design projects to respect the development pattern of the neighborhood and complement the neighborhood character valued by the community.
- A-2 Design projects to enhance the appearance of and contribute positively to the existing visual context of the neighborhood.
- A-3 Locate and orient buildings to respect the need for privacy, light, and air of surrounding structures.

### DESIRABLE



Tucking new small-lot single-family homes behind existing homes on deep lots preserves the existing single-family character and scale of the neighborhood. (Guideline A-1)

### DESIRABLE



The design of this new small-lot single-family home, located behind an existing home, includes stepbacks and articulation, and contributes positively to the existing visual context of the neighborhood. (Guideline A-2)

### UNDESIRABLE



Although the second story is stepped back from the street, the location of the garage, and the lack of landscaping, entryway, windows, and articulation along the front building facade produce an undesirable project. (Guideline A-2)

### UNDESIRABLE



These new small-lot single-family homes, located behind an existing single-family home, lack stepbacks from the property line and do not respect the need for privacy, light, and air of surrounding structures. (Guideline A-3)

## DESIRABLE



The taller portion of this multi-family residential project is located at the corner, away from adjoining properties, to maximize light, air, and privacy for units within and adjacent to the project. (Guideline B-2)

## DESIRABLE



The third story of these townhomes are stepped back from the stories below which reduces the visual impact of third story. (Guideline B-3)

## UNDESIRABLE



The three-story project lacks any setbacks and towers over adjacent property. (Guideline B-3)

## UNDESIRABLE



The lack of setbacks in this townhome project results in a tall and flat facade. (Guideline B-3)

## B. BUILDING HEIGHT AND FORM

### Building Height

These guidelines ensure that the scale of the project is compatible with adjacent buildings, and tall buildings do not overwhelm smaller scale buildings or block access to light and sun.

**B-1** Design buildings to be respectful of adjacent buildings, and create transitions of appropriate height and scale.

**B-2** Locate the taller portions of residential projects away from adjoining properties, in order to provide height transitions between taller and lower buildings, and to maximize light, air, and privacy for units.

**B-3** In low and medium density residential zones, reduce the visual and shadow impact of upper stories by using one or more of the following design strategies:

- Locate upper stories in the center of the property,
- Step back the upper stories from the stories below,
- Tuck the upper stories inside a pitched roof,
- Use pitched roofs with dormer windows for upper story rooms.

**B-4** In areas where the prevailing development is single-story, step back the upper stories along the public street frontage to maintain compatibility with the single-story character.

**B-5** In hillside areas, design buildings to step down the hillside, following the slope of the land, rather than having tall down-slope walls that are highly visible from surrounding properties and which are not consistent in scale with existing neighborhoods.

### DESIRABLE



In this hillside subdivision, building height and bulk is minimized through horizontal and vertical setbacks and step-backs. (Guideline B-4)

### UNDESIRABLE



The tall walls and over scaled entry of this single-family home exaggerate the height and scale of the building. (Guideline B-4)

### UNDESIRABLE



This single-family home does not step down the hillside, resulting in a tall downslope wall that is highly visible and out of scale with surrounding neighborhoods. (Guideline B-4)

## DESIRABLE



In this multi-family project, horizontal and vertical setbacks and stepbacks help break the building into smaller discrete masses. (Guideline B-5)

## DESIRABLE



In this townhome project, changes in roof form and recesses minimize the bulk of the building. (Guideline B-7)

## UNDESIRABLE



In this townhome project, the lack of setbacks and stepbacks results in one long continuous flat wall. (Guideline B-6)

## UNDESIRABLE



In this example, the lack of building breaks and substantial recesses results in a long and bulky façade. (Guideline B-7)

## Building Form and Bulk

These guidelines ensure that continuous buildings with attached or stacked units on deep narrow lots do not end up being overly long and bulky, creating an incompatible institutional character within residential neighborhoods.

**B-6** Design residential projects to avoid large box-like forms with continuous unrelieved surfaces.

**B-7** Include articulation at a minimum along the public and private street frontage, and project side and rear yards, such that the bulk as seen from existing neighbors is reduced. (See Building Articulation.)

**B-8** Minimize the bulk of the buildings by limiting building length, or designing buildings with two or more of the following special features to break up building bulk, including:

- Horizontal and vertical setbacks and stepbacks (instead of a long flat wall),
- Changes in roof form and height,
- Major full-height recesses (typically at least 10 feet deep) along the length of the building that successfully break the building into smaller discrete masses.

**B-9** Ground level parking podiums and lobbies can be continuous without a break if the above guidelines are met.

## C. BUILDING RELATIONSHIP TO THE STREET

### Front Yards

These guidelines ensure that landscaped front yards in residential neighborhoods create an attractive neighborhood character and “curb appeal” along the street to increase the value of homes throughout the neighborhood.

**C-1** Design front yard setbacks to provide a pedestrian scale and enhance the street, with setback dimensions that are generally consistent with the other buildings on the block.

**C-2** Maximize front yard landscaping, through the following strategies:<sup>1</sup>

- Limit paved areas to those which are necessary for auto circulation and pedestrian access to the front door.
- Use narrow paved wheel strips instead of wide paved driveways.
- Narrow driveways at the street and widen them closer to the garage entrance.
- Provide walkways to front doors that are no more than four feet wide. Incorporate landscaping into the walkway (if feasible given handicapped access needs.)
- Use permeable paving for pedestrian walkways.
- Use permeable paving for driveway aprons.

### DESIRABLE



The landscaped front yards help provide a pedestrian scale along the street and create an attractive neighborhood character. (Guideline C-1)

### UNDESIRABLE



Excessive paving in this front yard creates a barren street frontage. (Guideline C-2)

### DESIRABLE



This driveway apron uses narrow paved wheel strips to maximize landscaping. (Guideline C-2)

1. See Endnote

## DESIRABLE



A primary entrance, front porch, and primary living space windows on this street-facing façade create an attractive appearance that enhances the surrounding neighborhood. (Guideline C-3)

## DESIRABLE



A trellis signals the route to entry to this multi-family residential project. (Guideline C-4)

## UNDESIRABLE



The lack of primary windows and a front entrance on this street-facing façade results in a building that does not relate to the street or surrounding neighborhood. (Guideline C-3)

## DESIRABLE



Although this is one continuous façade, the individual units are articulated with different designs, roof forms, and individual entrances. (Guideline C-5)

## Building Orientation, Entrances, and Street-Facing Facades

These guidelines ensure that projects create an attractive street appearance that contributes to neighborhood character, establishes a sense of community, and fosters social interaction among neighbors.

**C-3** Design the street-facing façade to orient towards the public street, or private street if lot does not abut public street. Incorporate a front porch, front door, primary living space windows, building articulation elements (such as cornices, brackets, overhangs, shutters, window boxes, etc.), and extensive front yard landscaping to create an attractive street appearance that enhances the surrounding neighborhood.

**C-4** Locate the primary front entrance of residential units to face public, or private streets if lot does not abut public street.

- Where it is not feasible to locate the front door facing the street due to topography or other physical constraints, provide a trellis or landscaped courtyard entry to signal the route to the entry. Use accent landscaping and special landscape elements, such as feature planting, including free-standing columns or trellises with vines for vertical accent, to give visual expression to site circulation, especially at entrances and exits.

**C-5** In areas where the prevailing character is single-family detached development, design the public street facing façade to “read” like single unit structures. Examples include shifting the units in section, varying the design treatment for individual units, and incorporating individual unit entrances along the façade.



## D. BUILDING DESIGN

These guidelines seek to create unified and harmonious building compositions, promote quality architecture, and visual diversity. No official architectural style is dictated or preferred.

### Architectural Style

- D-1 Design projects with a consistent design integrity, exhibited by all building components including, but not limited to, building mass and articulation, roof forms, windows (proportion and design), building materials, facade details (doors and entrances), fencing, and landscaping.
- D-2 Avoid combining structural and decorative characteristics from different architectural styles into a single building.

### DESIRABLE



This home exhibits design integrity through roof forms (low roof line), building massing (second story tucked under roof to preserve single-story appearance), materials (siding), and windows (large windows with shutters) that are consistent with the Ranch style. (Guideline D-1)

### UNDESIRABLE



Although this home may be considered Neo-Eclectic, it exhibits less architectural integrity, compared to the project on the left, as it incorporates different architectural styles (Ranch, Spanish Revival, etc.) into a single building. (Guideline D-2)

### DESIRABLE



This home exhibits design integrity through roof forms (roof has numerous steep pitches), building massing (turret), building materials (first story stone veneer), and windows (several windows of different shapes) that are consistent with the Tudor style. (Guideline D-1)

## DESIRABLE



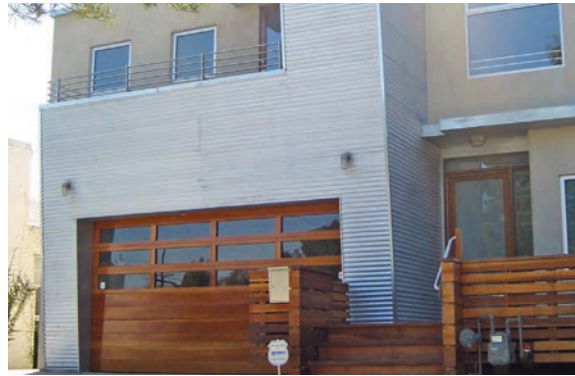
This project uses a unified palette of materials, where wood finishes and the different siding serve to complement one another. (Guideline D-6)

## DESIRABLE



A bright blue color is used around the garage door and windows as an accent color. (Guideline D-9)

## UNDESIRABLE



Aluminum siding is not a desirable building material. (Guideline D-5) For mixed-use (residential/commercial) or contemporary architectural styles, exceptions that require design review and public hearings may be appropriate.

## Building Materials

- D-3 Use building materials that convey a sense of durability and permanence. Use high quality materials that will last for the life of the building. Install materials so that building facades do not stain or deteriorate quickly.
- D-4 Use the highest quality and most durable materials at the base of buildings, because those can be most impacted by landscaping, people, and automobiles.
- D-5 Use exterior siding materials such as stucco, wood siding, masonry, tile, wood shingles, metal panels, and glass panels. Scored plywood and aluminum siding are not desirable. For mixed-use (residential/commercial) or contemporary architectural styles, exceptions that require design review and public hearings may be appropriate.
- D-6 Use a complementary palette of materials on all four sides of buildings. Use building materials of similar durability and quality throughout the project.
- D-7 Locate material changes at interior corners as a return at least six feet from the external corners or other logical terminations; and not at external corners.

## Building Colors

- D-8 Select a coordinated palette of complementary colors, rather than a patchwork of competing colors.
- D-9 Use bright and/or dark colors only as accent colors on trim.
- D-10 Do not use fluorescent or neon colors.
- D-11 Select a set of colors that is compatible with the surrounding neighborhood visible from the subject property.

## Building Articulation

D-12 Design doorways, columns, overhangs, and other architectural elements to be substantial in depth, in order to create shadow and architectural relief. Incorporate at least three of the following features, consistent in design style, that provide articulation and design interest consistently throughout the project:

- Decorative trim elements that add detail and articulation, such as door surrounds with at least a two-inch depth, decorative eave detailing, belt courses;
- Pitched / variegated roof forms;
- Roof overhangs at least 18 inches deep;
- Variety in use of materials, especially at ground level stories, for detailing at porches / entry areas, paneling at bays or at special parts of the building;
- Building base (typically bottom three feet) that is faced with a stone or brick material, or is delineated with a channel or projection; and/or
- Railings with a design pattern and materials such as wood, metal, or stone which reinforces the architectural style of the building.

### DESIRABLE



The detailing of the roof eaves and recessed entry add depth the street-facing facade of this home. (Guideline D-12)

### DESIRABLE



Pitched and variegated roof forms along with roof overhangs on this single-family home help create a visually interesting façade. (Guideline D-12)

### UNDESIRABLE



The lack of window recesses and trim of substantial depth on the side wall of this townhome project results in a long flat continuous side wall that impacts the adjacent neighboring single-family residence. (Guideline D-12)

### UNDESIRABLE



Although this townhome project has several building articulation elements, the inappropriate scale of these elements along with the lack of architectural integrity produce an overly bulky and unsuccessful design. (Guideline D-12)

## DESIRABLE



Overhangs, chimneys, and balconies add architectural interest to this multi-family project. (Guideline D-13 & D-14)

## DESIRABLE



Changes in roof height helps break the project down to smaller individual masses. (Guideline D-16)

**D-13** Incorporate projections and recesses throughout the façade design to add architectural interest and a visual play of light and shadow. Examples include: bay windows, chimneys, front porches, balconies, overhangs, brackets, and cornices.

**D-14** Incorporate building projections that enhance the design and articulation of the building. These may project into required front, side, and rear yards up to the limits allowed in the development standards.

## Roof Forms

**D-15** Incorporate variable roof forms into the building designs, to the extent necessary to avoid a boxy appearance of residential buildings. This may be accomplished by changes in roof height, offsets, change in direction of roof slope, dormers, parapets, etc.

**D-16** Design roof forms such that no more than two side-by-side units are covered by one unarticulated roof. Articulation may be accomplished by changing roof height, offsets, and direction of slope, and by introducing elements such as dormers, towers, or parapets. Other alternative design approaches that achieve the same goal of breaking down building masses into small individual units may also be acceptable, for example shifting the units in section and varying the design treatment for individual units.

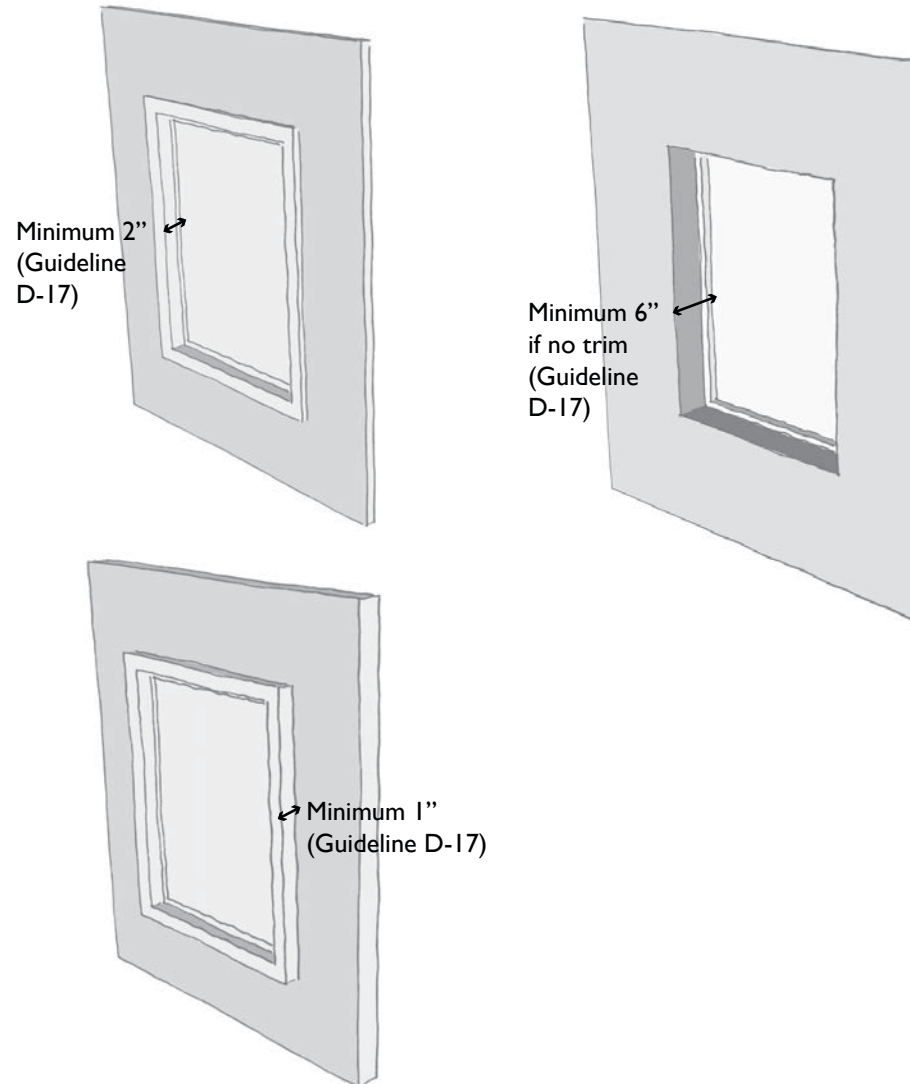
## Windows

**D-17** Design window patterns and proportions to enhance all facades of the building and add architectural interest. Differentiate window designs (size, proportion) to reflect the different components of residential units, (for example entrances, living areas, stairways, and bedrooms) while ensuring harmony within that variety.

**D-18** Design windows recesses, window trim and other window elements to be substantial in depth to create shadows and add architectural interest. Incorporate at least one of the following window features throughout the project:

- Minimum depth of at least two inches from glass to exterior of trim;
- Minimum depth of at least six inches from glass to wall edge around windows if there is no trim (this is only appropriate for certain architectural styles such as Spanish Revival or Modern);
- Decorative trim elements that add detail and articulation, such as window surrounds with at least a two-inch depth. They must be designed as an integral part of the design, and not appear “tacked-on.”

## DESIRABLE



### DESIRABLE



The building entrance to this home is appropriately scaled and helps to create a more pedestrian friendly street frontage. (Guideline D-20)

### UNDESIRABLE



In this example, the over-scaled building entrance exaggerates the scale of the structure. (Guideline D-20)

### Doors and Entrances

- D-19 Emphasize building entrances with special architectural and landscape treatments.
- D-20 Design building entrances so that they are not over-scaled relative to the size of the buildings, such that they exaggerate the scale of the structure.

## Remodeling and Additions

**D-21** Design additions to existing buildings with consideration for the overall form of the resulting building; additions must not mix styles or introduce incongruous design motifs to an existing building.

**D-22** Design additions to have similar massing volumes consistent with the original building with second story additions articulated such that not all exterior faces of the second story walls are directly above the first story walls.

**D-23** Design remodeling projects and additions such that the exterior appearance of the building demonstrates design integrity in the following ways:

- Use complementary materials for exterior facades;
- Use window types that are similar in size, shape and proportion of the windows on the original building;
- Use consistent roof materials and roof forms.

**D-24** Do not close, move or enlarge exterior openings for doors and windows without consideration for the overall composition of the building, including all other remaining exterior openings.

**D-25** Do not remove or cover high quality original finish materials and ornamentation integral to the design integrity of the building with new incompatible materials.

**D-26** Design new windows and doors to match existing window, door and hardware materials, except when the existing materials are of low quality, in which case they all shall be replaced with high-quality materials.

### DESIRABLE



The second story addition has a roof form and roof materials consistent with the first story garage. (Guideline D-23)

### DESIRABLE



The second story addition is located away from the adjacent property, which minimizes bulk and impacts on adjoining properties. (Guideline D-22)

### UNDESIRABLE



The roof form of the second story addition is not consistent with the existing roof forms and the window is not consistent with the first story windows. (Guideline D-23)

### UNDESIRABLE



The second story addition does not match the window proportion or siding of the first story. (Guideline D-21)

## DESIRABLE



A landscaped setback provides light, air and privacy for residential units in the project, as well as residential units in adjoining buildings. (Guideline E-1)

## DESIRABLE



A larger side setback in this single-family home (which resulted from a rear setback exception) has enough depth to create a usable private open space area that can accommodate seating areas. (Guideline E-2)

## DESIRABLE



In this multi-family residential project, units on the ground floor have adequate access to light and air due to the separation between the buildings. (Guideline E-4)

## E. BUILDING SETBACKS FOR LIGHT, AIR, AND PRIVACY

The purpose of these guidelines is to ensure adequate setbacks for residential units in the project and ensure the project respects the residential units in adjoining buildings.

- E-1 Provide adequate light, air, and privacy for residential units in the project, as well as residential units in adjoining buildings.
- E-2 Provide rear setbacks that have sufficient depth to create usable open space areas that can accommodate chairs and tables, outdoor grills, gardening, and other outdoor activities.
- E-3 Incorporate lower building heights and greater side and rear yard setbacks for portions of projects that are adjacent to lower density residential zones.
- E-4 Provide distance between buildings on the same project site that is adequate to ensure light, air and privacy for adjacent residential units and to minimize shadows on open space.
- E-5 Use design strategies to protect privacy, such as offsetting windows of adjacent units, locating minor windows above eye level, and using opaque glass for minor windows.



## F. AUTO CIRCULATION: SITE ACCESS, STREETS, AND DRIVEWAYS<sup>2</sup>

These guidelines ensure a safe and convenient pedestrian environment and an attractive street frontage to accommodate pedestrian and bicycle activities.

- F-1 Minimize the number of curb cuts, to minimize interruptions in the sidewalk and maximize front yard landscaping.
- F-2 Space curb cuts so as to preserve on-street parking and minimize paving.
- F-3 Maximize the use of shared access driveways when driveways are closer than 50 feet apart; if a project's access driveway is adjacent to an existing access driveway, a landscaping buffer of at least 5 feet in width must be provided between the access driveways.
- F-4 Design private driveways, private streets, and public streets according to the Engineering Design Guidelines for Unincorporated Alameda County.
- F-5 Gates for townhouse housing or for single-family detached "gated communities" are strongly discouraged.

### DESIRABLE



If driveways are to be located next to each other, extensive landscaping must be installed between the two driveways to improve the street appearance and the outlook from residences. (Guideline F-3)

### UNDESIRABLE



If the two driveways were shared, the resulting residential lots would be larger and there would be more landscaping and open space. (Guideline F-3)

---

2. See Endnote

## DESIRABLE



Tuck Under Parking. Parking is located on the ground floor under the units. (Guideline G-1)

## DESIRABLE



Parking Wrapped with Living Space. Parking is located on the ground, wrapped with residential units. (Guideline G-1)

## G. PARKING LOCATION AND DESIGN<sup>3</sup>

These guidelines ensure that the visibility of parking is minimized from public streets and that parking areas will not create a negative visual outlook for the residential units.

### Parking Location

**G-1** Locate parking to the side or rear of buildings, or underneath buildings and avoid land intensive surface parking lots. Typical design solutions for Alameda County lots are shown below:

- Side Parking
- Rear Yard Parking
- Below Grade Parking
- Tuck Under Parking
- Parking Wrapped with Living Space

**G-2** Do not locate parking between the building and the street or access driveway. Landscaped front yards along the street need to be preserved to create an attractive neighborhood appearance.

**G-3** In ACBD RC districts, accommodate resident parking on-site interior to or at the back of the site where it is not visible to the street, and/or by garage space in the building where no more than one garage door is visible to the street. Apartment type buildings built over exposed parking spaces are not permitted.

**G-4** Minimize the prominence of driveways and parking garages within the front façade and the front yard.

---

3. See Endnote

G-5 Locate garage entrances and driveways to the side of the property instead of at the center.

### Parking Lot Layout

G-6 Disperse contiguously paved parking areas throughout the project in smaller segmented parking areas, rather than creating large parking lots.

### Parking Garages

G-7 Reduce the prominence of garage doors through one or more of the following strategies:

- Locate the garage door behind the front porch and/or living space, relative to the front lot line;
- Design the second floor to overhang beyond the garage door.
- Locate the garage to the side of building rather than at the center.
- Three-car garages for single-family houses:
- For garages with three or more non-tandem parked cars, the area of the front wall(s) of garages(s) should not be more than 25% of the cumulative exterior front walls of a two story single-family residential building; no more than 50% of the cumulative exterior front walls of a one story single-family residential building; and at least one front wall of a three-car garage must be separated from the remaining garage front wall by at least two feet. Three story single-family residential buildings should be no more than 20% of the cumulative exterior front walls to be the area of the front wall of the garage.

### DESIRABLE



The garage is located behind the front porch and living space, allowing the entry of unit to become the prominent feature. (Guideline G-7)

### DESIRABLE



The garage is located to the rear of the building, which minimizes the visibility of the garage. (Guideline G-7)

### UNDESIRABLE



Locating the garage in the center of the street makes the garage extremely prominent and detracts from street appearance. (Guideline G-7)

## DESIRABLE



Landscaping between the sidewalk and the street helps create a buffer for pedestrians from cars. (Guideline H-1)

## DESIRABLE



Provide sidewalks within residential projects, connecting from the street or driveway to building or unit entrances. (Guideline H-2)

## H. FACILITIES FOR WALKING, BICYCLE, TRANSIT<sup>4</sup>

These guidelines ensure that adequate and safe facilities for pedestrians, bicycles, and transit users are provided in addition to auto circulation.

### Sidewalks, Street Trees, and Other Public Right-of-Way Improvements

H-1 Provide new or repaired improvements in the public right-of-way along the lot frontage, including sidewalks, street trees, curbs, and gutters, following the Alameda County Engineering Design Guidelines and CVCBD Specific Plan (when applicable).

### On-Site Pedestrian Walkways

H-2 Provide sidewalks within residential projects, connecting from the street or driveway to building or unit entrances.

H-3 Provide walkways delineated with decorative paving for projects where sidewalks are not required.

### Decorative Paving

H-4 Incorporate decorative, pervious paving into paved and landscaped areas in order to enhance the appearance of the project, reduce the visual impact of paved surfaces and act as a traffic calming measure. Decorative paving includes: brick, stamped colored concrete, stone blocks or pavers, interlocking colored pavers, grasscrete, and other comparable materials.

---

4.. See Endnote

H-5 Locate decorative paving in the following priority locations:

- The first 20 feet of the driveway closest to the street;
- A four-foot wide pedestrian path along the length of the driveway, if no sidewalk is provided;
- Parking maneuvering areas;
- Parking aprons; and
- Parking areas or fire turnarounds that can also occasionally function as outdoor courtyards.

### Bicycle Parking and Storage

H-6 Provide accessible and secure on-site bicycle parking/storage facilities.

### Transit Shelters

H-7 If the provision of a transit shelter is required, provide transit shelter that enhances the streetscape and that offers adequate seating and shade.

### DESIRABLE



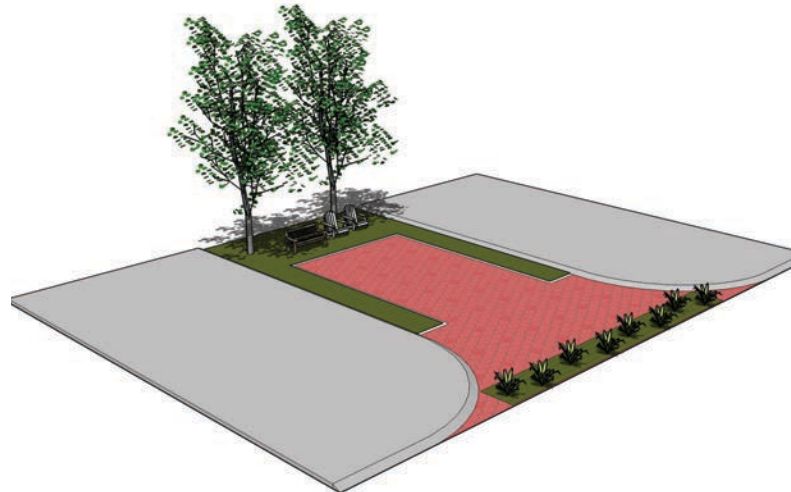
Decorative paving in the driveway signals to cars that the driveway is shared with pedestrians and that pedestrians have priority. (Guideline H-3 & H-5)

### DESIRABLE



Decorative paving at the street reduces the visual impact of paved surfaces and acts as a traffic calming measure. (Guideline H-4 & H-5)

### DESIRABLE



Designate areas that can occasionally function as outdoor courtyards (e.g. fire turnaround) with decorative paving. (Guideline H-5)

## DESIRABLE



Landscaping in this project helps create an attractive visual outlook for residents. (Guideline I-1)

## DESIRABLE



Locate landscaping between the driveway and adjacent property to provide privacy between the two properties. (Guideline I-5)

## DESIRABLE



Locate landscaping between the building and driveway to create a buffer between residents and cars. (Guideline I-5)

## DESIRABLE



Locate landscaping between the building and parking areas to screen surface parking areas from residents. (Guideline I-5)

## I. SITE LANDSCAPING<sup>5</sup>

These guidelines serve to ensure that projects provide landscaping to manage stormwater, support passive heating and cooling, improve air quality, provide an attractive visual outlook for residences, and beautify neighborhoods and communities. In addition, the following guidelines support the use of landscaping as an integral part of design to promote quality of life and the environment.

### Site Plan and Landscaping Treatments

- I-1 Incorporate landscaping in order to create an attractive visual outlook for residential units, create usable open space, maximize stormwater infiltration, and provide privacy for adjacent residential units.
- I-2 Design site landscaping treatments to be attractive, with a consistent design integrity throughout the project.
- I-3 Design front yard areas to be compatible with streetscape improvements on the adjacent public right(s)-of-way.
- I-4 Front and street-side yard landscaping shall be primarily of living plant materials; rock materials or other inorganic material shall be minimized.

### Site Landscaping Locations

- I-5 Provide site landscaping in the following priority areas:
  - Along the edge of streets and driveways
  - Along the property perimeter
  - Between buildings and driveways
  - Between buildings and parking
  - Within common open space areas

---

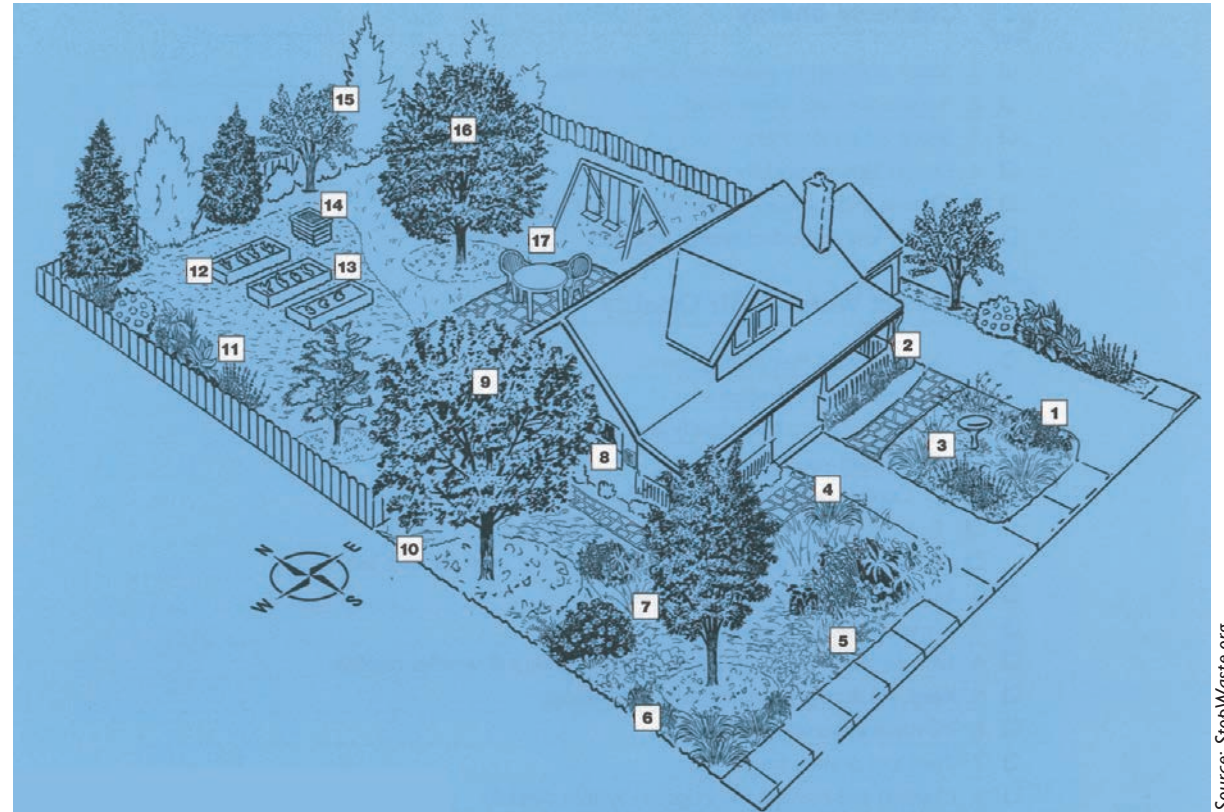
5. See Endnote

- I-6 Do not reduce the amount of existing landscaping on site.

### Site Landscaping Materials

- I-7 Provide landscaping to comply with the State's Water Efficiency Landscape Ordinance (AB-1881), as amended, and as incorporated into the local Alameda County WELO ordinance.
- I-8 Select landscaping materials that meet the following criteria:
- Hardy enough to withstand close contact with pedestrians and vehicles
  - Sized large enough at the planting stage to take root and survive into maturity
  - Non-invasive plants that are not listed by the Invasive Species Council of California (ICSS) in the "invasive species list and scorecard of California", as amended.
- I-9 Landscape areas requiring higher water usage for maintenance are encouraged to be located in small courtyards and other kinds of intensively used areas.

### DESIRABLE



Source: StopWaste.org

#### Bay Friendly Landscaping Principles and Practices from StopWaste.org

- 1 Permeable paving on driveway and walkway to front door
- 2 Water from roof channeled to cistern
- 3 Water for wildlife habitat
- 4 Pavers with spaces and low water use plants between
- 5 Front lawn replaced by diverse plantings with many California native groundcovers, shrubs and trees, but no invasive species
- 6 All plants given the space to grow to their natural size
- 7 Plants selected to match microclimates
- 8 Irrigation controller waters hydrozones according to plant needs, soil moisture and weather
- 9 Deciduous trees placed to the west & southwest of the house & patio for summer cooling
- 10 Repository for leaves to collect under trees as mulch
- 11 Mulched paths keep soil covered
- 12 Drip irrigation for vegetable beds, shrubs, trees and elsewhere where feasible
- 13 Raised beds are constructed from durable material
- 14 Compost bin recycles plant and kitchen debris
- 15 Evergreen windbreak blocks north winter winds
- 16 Trees not topped but pruned properly
- 17 Small lawn in backyard where family will use it

## DESIRABLE



Trees and landscaped islands throughout the parking areas help improve the appearance of the project. (Guideline I-9)

## DESIRABLE



Stormwater management areas such as a green roof are integrated into the building design. (Guideline I-14)

## DESIRABLE



Stormwater management areas are integrated into the site landscaping. (Guideline I-10)

## DESIRABLE



Landscaped areas serve as stormwater management areas as well as visual amenities. (Guideline I-13)

## Parking Area Landscaping

- I-10 Landscape parking lots, driveways, and other auto circulation areas in order to improve the visual appearance of circulation and parking areas from residential units, from the common areas of the project, and from adjacent properties.
- I-11 Incorporate trees, landscape islands, shrubs, and groundcover throughout parking areas, consistent with required standards.
- I-12 Shade paved surfaces to the maximum extent feasible in order to reduce heat gain and other environmental effects.

## Stormwater Management

- I-13 Incorporate best management practices for stormwater management, per Alameda County requirements under the Clean Water Act permit (Municipal Regional Stormwater Permit of October 14, 2009) and per the Alameda County Engineering Design Guidelines.
- I-14 Design landscaped areas to serve as stormwater management areas as well as visual amenities.
- I-15 Innovative stormwater management practices are encouraged; integrate stormwater management facilities, such as Site Design, Treatment, Source Control, and Hydromodification Management measures, in combination with Low Impact Development, into the site landscaping per the requirements of the Municipal Regional Permit (MRP). Use of mechanical management systems are generally not allowed.



## J. USABLE OPEN SPACE<sup>6</sup>

These guidelines ensure that projects provide enjoyable usable outdoor living areas for residents and light access, privacy, and a sense of openness is maintained in higher density developments.

### Usable Open Space for Residents

**J-1** Provide both common open space and private open space for residents' recreation and relaxation.

- Design common open space as a space where people can interact, host guests, and also enjoy some time alone in the fresh air.
- Design private open space for the exclusive use of household members to eat outside, garden, enjoy the fresh air, grill outdoors, etc.

**J-2** Provide usable open space that may have a dual function for stormwater treatment and incorporates strategies such as grassy swales, vegetated swales, flow through planters, rain gardens, etc.

### Common Open Space: Courtyards, Plazas, and Green Spaces

**J-3** Design common open space(s) to be a shared open space for use by all residents.

**J-4** Include seating areas and other passive recreation facilities.

---

6. See Endnote

### DESIRABLE



This common open space area provides amenities such as chess tables, gardens, and seating to facilitate interaction among neighbors. (Guideline J-1)

### DESIRABLE



This common open space area provides tables, chairs and a barbecue. (Guideline J-1)

### UNDESIRABLE



This private patio open space does not have enough area for the use of household members to eat outside, enjoy the fresh air and grill. (Guideline J-1)

## DESIRABLE



Common open space is located in a central location that serves all the units. (Guideline J-5)

## UNDESIRABLE



This children's play area, located at the extreme edge of the property and surrounded by parking, is not ideally located. (Guideline J-5)

- J-5 Locate common open space(s) in a central location that serves all the units, not at an extreme edge of the property. Common open space can be on the ground, or in courtyards above the ground level.
- J-6 Include landscaping with trees, shrubs, and groundcover. If the space is not located on the ground, include extensive pots and planter boxes that accommodate trees, shrubs, and groundcover. See Site Landscaping Materials section for appropriate materials.
- J-7 Include children's play areas in one of the common open spaces, unless the size and layout of the units are targeted exclusively towards empty-nesters, singles, and seniors.

## Private Open Space: Yards, Patios, and Balconies

- J-8 Design private open space to be used exclusively by a single unit.
- J-9 Locate private open space in patios, balconies, decks, or other outdoor spaces attached to individual units.
- J-10 Dimension private open space so there is room for a table and chairs where residents can sit outside.
- J-11 Provide landscaped areas that provide opportunities for planting and/or gardening in ground level spaces.

## DESIRABLE



Provide landscaped areas that provide opportunities for planting and/or gardening in ground level spaces. (Guideline J-11)

## K. FENCES AND WALLS

These guidelines ensure that fences and walls contribute to an attractive street appearance.

- K-1 Design fences and walls to be an attractive part of the project, with materials and designs that are compatible with the exterior building materials and demonstrate integrated design integrity in the project as a whole.
- K-2 Locate fences or walls on the property to define private open space and common open space areas, protect privacy and buffer residents from noise sources
- K-3 Use masonry materials for sound reduction purposes.
- K-4 Gates for townhouse housing or for single-family detached “gated communities” are strongly discouraged.

### DESIRABLE



This fence located along the street edge enhances the street appearance. (Guideline K-1)

### DESIRABLE



A solid wall located along the front yard is hidden behind landscaping and therefore is less imposing on the pedestrian realm. (Guideline K-2)

### UNDESIRABLE



In this example, the excessively tall wall and lack of landscaping detract from neighborhood appearance. (Guideline K-2)

### DESIRABLE



Retaining walls step down the hillside and are integrated into the landscaping, minimizing their bulk and visual impact. (Guideline K-2)

## DESIRABLE



The loading area incorporates landscaping features which help increase site landscaping in the project. (Guideline L-3)

## UNDESIRABLE



Utilities should not be located in the middle of the required front yard and landscaping should effectively minimize the visibility of the utilities box from the street. (Guideline L-7)

## L. SERVICES

Service area guidelines ensure that these areas do not detract from the overall quality of the common areas within projects. Additionally, they ensure that pedestrian connections are not disrupted by service or loading areas.

### Goal

Garbage receptacles are to be screened from view from any street when not on garbage pick-up day, or the day before or the day after.

### General

**L-1** Within Multi-family housing “flats”, locate ancillary facilities such as trash receptacles and utility meters within buildings, not along the front street facing façade, to the maximum extent feasible. Where ancillary facilities absolutely cannot be incorporated into a building, locate them in freestanding, completely enclosed structures designed to be compatible with the architecture of the rest of the development

### Loading

**L-2** Design streets and driveways to accommodate vehicles commonly used for moving residents’ belongings.

**L-3** Minimize the visibility of loading areas in multi-family residential complexes, and screen them with screen walls, landscaping, and other devices.

## Trash

- L-4 Provide on-site facilities for trash storage and for recyclable materials.
- L-5 In general, decentralized bins are to be provided for each unit within detached single-family and townhome development; and centralized enclosures are to be installed within complexes for multi-family “flats”.
- L-6 In coordination with applicable collection services and Alameda County, provide centralized garbage, recycling, and/or compost dumpsters inside covered trash enclosures for multi-family residential complexes.
- L-7 Build covered garbage, recycling, and/or compost enclosures to comply with the Municipal regional Permit (MRP), with durable materials such as stone, concrete block, steel, or heavy timber.
- L-8 Decentralized garbage, recycling, and/or compost bins should be located behind a fence or otherwise not visible from the public or private roadway.

## Utilities

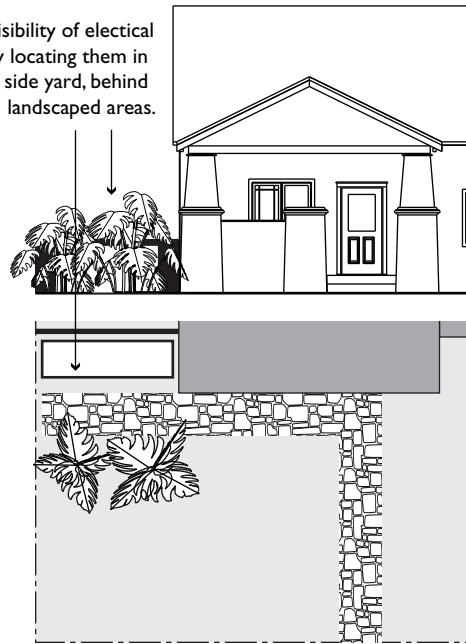
- L-9 Locate electrical panels to minimize their visibility from the street, in locations such as side yard walls, and/or behind landscaped areas. Integrate them into the design of residential buildings to the maximum extent feasible.
- L-10 Minimize the visibility of utilities connections from the public street.

## Storage

- L-11 Provide bulk storage areas in garages or in residential units, so that people use their garages for auto parking and avoid outdoor storage of large household goods.

## DESIRABLE

Minimize visibility of electrical panels by locating them in the side yard, behind landscaped areas.



## UNDESIRABLE



Electrical panels should not project from the wall; they should be located on the side yard wall, or behind ample landscaping. (Guideline L-9)

## ENDOTE

When meeting the design guideline or the design guidelines within this topic, the project must exhibit an overarching intent to reduce water quality impacts of development. Site Design Measures in combination with Low Impact Development and must be integrated into development projects wherever feasible and practicable.

# 4

# DEVELOPMENT STANDARDS FOR RESIDENTIAL MIXED-USE PROJECTS

This chapter presents standards for residential mixed-use projects in the Ashland and Cherryland Business District and the Castro Valley Central Business District. Although there are several different types of mixed-use development, this chapter only addresses mixed-use development that includes residential uses. Section 4.1 discusses the various districts in the unincorporated areas of West Alameda County in which residential mixed-use projects are allowed. Section 4.2 shows drawings to provide a summary of the major development standards in a visual format, followed by a table listing all the development standards. Standards in bold italics are existing County standards. This Chapter is organized by the following sections.

Policy 4-1: Residential Mixed-Use: Appropriate Zones and Densities

Policy 4-2: Residential Mixed-Use Standards



# 4.1 Residential Mixed-Use: Appropriate Zones and Densities

## Appropriate Zones and Densities

To ensure that new residential mixed-use development respects the scale and character of adjacent development, new residential mixed-use development should have densities appropriate to each zone or subarea in the Specific Plan. The table in this section shows the densities allowed in different zones and subareas of the Specific Plans.

**Policy 4-1:** Design projects consistent with the following table, which shows the appropriate density ranges within the Specific Plan zones and subareas. The table may be updated from time to time as the Specific Plans are updated.

The minimum building site per dwelling unit establishes the minimum developable lot area required for one dwelling unit. When calculating net density for single-family subdivisions, small-lot single family homes and townhomes, the following portions of the property are excluded from the calculation: private streets, access easements, stems, driveways that serve more than one lot, designated parking spaces, and any other unservable or unbuildable portion of the lot. This applies to all single-family subdivisions, small-lot single family homes and townhomes, regardless if they are rental or for sale units. This does not apply to air space subdivisions, or multi-family flats.

## Density Bonuses

A residential development that includes five or more dwelling units and meets one or more of the following criteria is entitled to a density bonus and one or more incentives under State Government Code Section 65915:

- (A) Ten percent of the total units of a housing development for lower income households, as defined in Section 50079.5 of the State Health and Safety Code.
- (B) Five percent of the total units of a housing development for very low income households, as defined in Section 50105 of the State Health and Safety Code.
- (C) A senior citizen housing development, as defined in Sections 51.3 and 51.12 of the State Civil Code, or mobilehome park that limits residency based on age requirements for housing for older persons pursuant to Section 798.76 or 799.5 of the Civil Code.
- (D) Ten percent of the total dwelling units in a common interest development as defined in Section 1351 of the State Civil Code for persons and families of moderate income, as defined in Section 50093 of the State Health and Safety Code, provided that all units in the development are offered to the public for purchase.

**TABLE 4.1-1: RESIDENTIAL MIXED-USE MAXIMUM DENSITIES AND APPROPRIATE ZONES**

ACBD: Ashland and Cherryland Business District Specific Plan / CVCBD: Castro Valley Central Business District Specific Plan				
<b>Building Type</b>	<b>Appropriate Zones</b>	<b>Minimum Building Site (square feet) Per Dwelling Unit<sup>1</sup></b>	<b>Maximum Net Density (Dwelling Units/Acre)<sup>2</sup></b>	<b>Notes</b>
<b>MIXED USE</b>	ACBD-RC (Residential/Commercial)		15 – 25	
	ACBD-TA (Transit Access)		Up to 50	
	ACBD-TC (Transit Corridor)		See General Plan	
	ACBD-FA (Freeway Access)		See General Plan	
	CVCBD Land Use Group D	2,500	17.4	With minimum lot size of 10,000 – 20,000 square feet
	Subareas 2, 4, 5, 6, 7, 11	2,000	21.8	With minimum lot size greater than 20,000 square feet
	Not allowed along Castro Valley Boulevard in Subareas 5, 6, 7 Subarea 7 Limitations: Allowed along side street frontage depending on factors such as specific use, design, adjacent uses, etc, Not allowed along Redwood.		20 – 40	Allowed where a development is substantially composed of units aimed at the elderly or handicapped, where units are mostly studios or one bedroom units, where the parcel is large enough that higher density development can successfully occur, where surface parking is minimized through parking structures, underground parking, etc, or where development is immediately adjacent to the BART station or intensive commercial development.
	CVCBD Land Use Group E Subareas 8, 9, 10 Subarea 9 Limitations: Allowed on parcels west of Redwood Road only.		40 – 60	

Notes:

1. The minimum building site per dwelling unit establishes the minimum developable lot area required for one dwelling unit.
2. When calculating net density for single-family subdivisions, small-lot single family homes and townhomes, the following portions of the property are excluded from the calculation: private streets, access easements, stems, driveways that serve more than one lot, street parking spaces, and any other unservable or unbuildable portion of the lot. This applies to all single-family subdivisions, small-lot single family homes and townhomes, regardless if they are rental or for sale units. This does not apply to air space subdivisions, or multi-family flats.

## 4.2 Residential Mixed-Use Standards

This section presents the development standards for mixed-use projects that include residential and commercial uses.

The purpose of the mixed-use residential standards is to allow for a variety of housing types in the unincorporated areas of Alameda County that serve all types of households, while also achieving neighborhood goals for an active pedestrian realm along transit corridors, an attractive street appearance, and minimizing impacts on neighboring properties. The standards are also to ensure a quality living environment that will be desirable and hold its value over time. When mixed-use residential projects are well designed, they can provide good quality housing and an active and vibrant commercial corridor.

There are many different types of mixed-use projects, depending on the types of uses developed together and whether these uses are integrated horizontally or vertically. The standards in this section apply to mixed-use projects with ground floor commercial uses along the street and residential uses above or behind the commercial uses.

Mixed-use residential development is typically a multi-story building with commercial uses on a ground floor, and a shared residential entry lobby, and common access areas such as hallways or stairways that lead to individual residential units above or behind the commercial uses. Parking is often shared, whether in a garage or parking court.

In certain instances, if a project is located on a large site, there may be a mixture of residential unit types, for example multi-family apartments and townhomes. In this case, each unit type should be designed to the specific standards and guidelines of the unit type.

Medium density mixed-use residential development is appropriate in Subareas 2, 4, 5, 6, 7, and 11 in the Castro Valley Central Business District Specific Plan area, with some limitations. (See Table 3.1-1) It is also appropriate in the Residential Commercial (R/C) and Freeway Access (FA) designations in the Ashland Cheryland Specific Plan area, along Lewelling Boulevard.

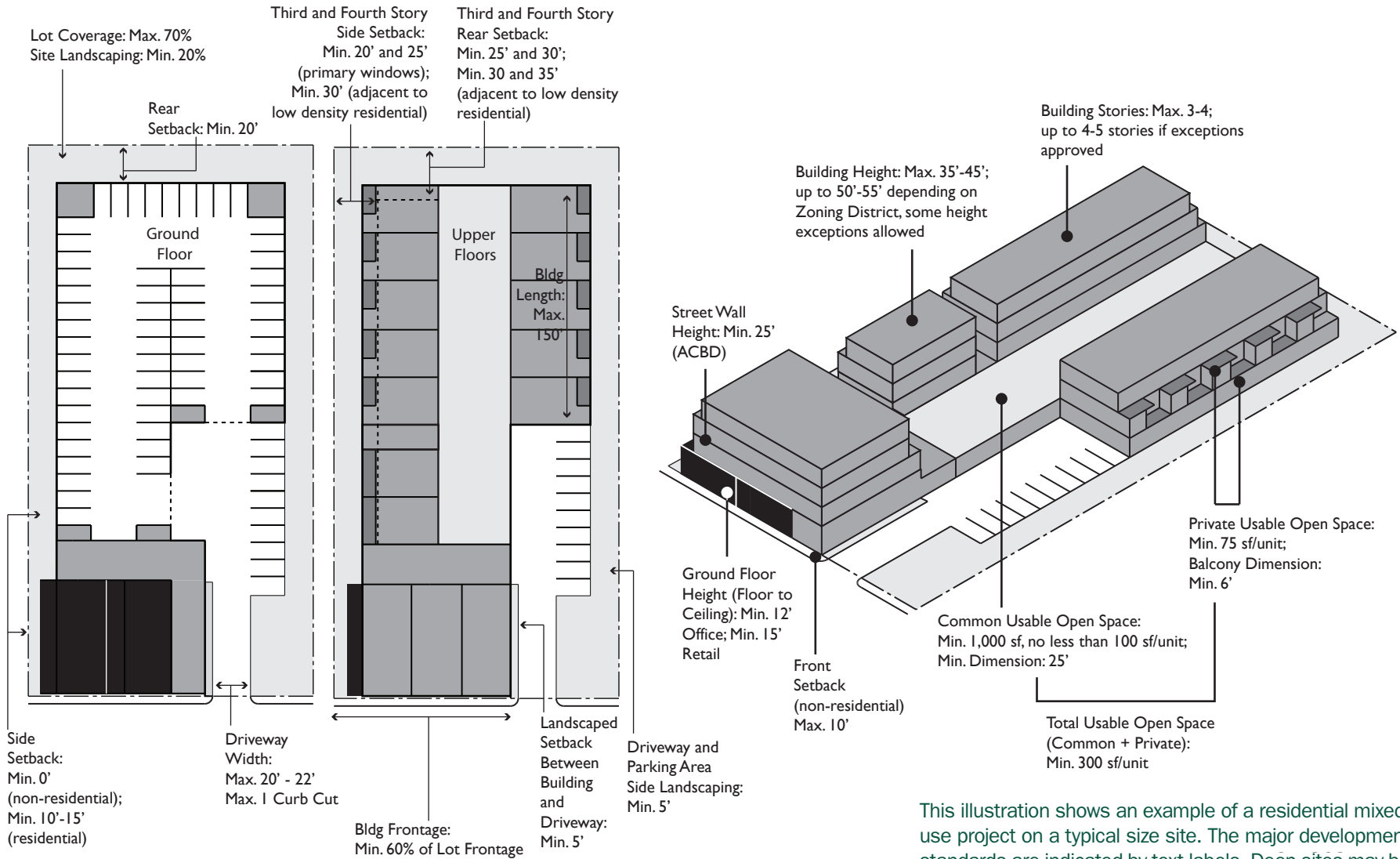
High density mixed-use residential development is appropriate in Subareas 8, 9, and 10 in the Castro Valley Central Business District Specific Plan Area, with some limitations. (See Table 4.1-1) It is also appropriate in the Transit Access (TA), Transit Corridor (TC) and Freeway Access (FA) designations in the Ashland Cheryland Specific Plan area, along East 14th Street and Mission Boulevard.



NOTE: Diagrams not to be used for density calculations. Not to scale.

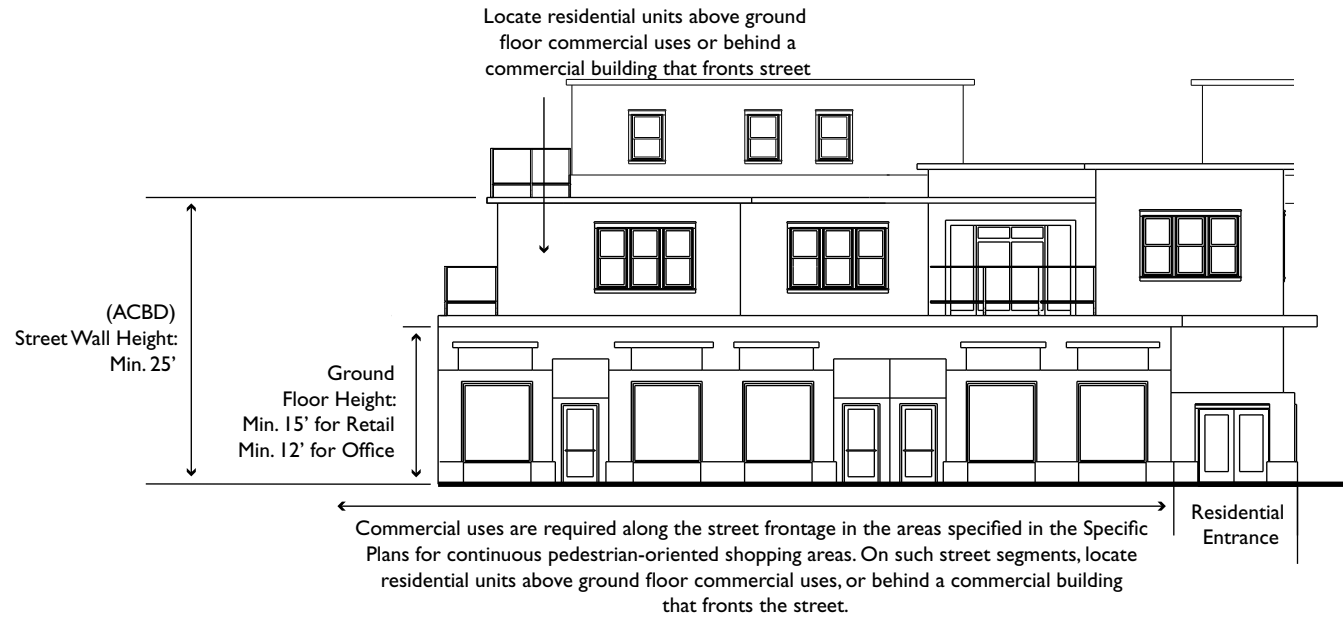
### Figure 4.2-1: Residential Mixed Use: Summary of Major Development Standards

NOTE: Diagrams not to be used for density calculations. Not to scale.



This illustration shows an example of a residential mixed-use project on a typical size site. The major development standards are indicated by text labels. Deep sites may be required to meet additional Fire Department Standards.

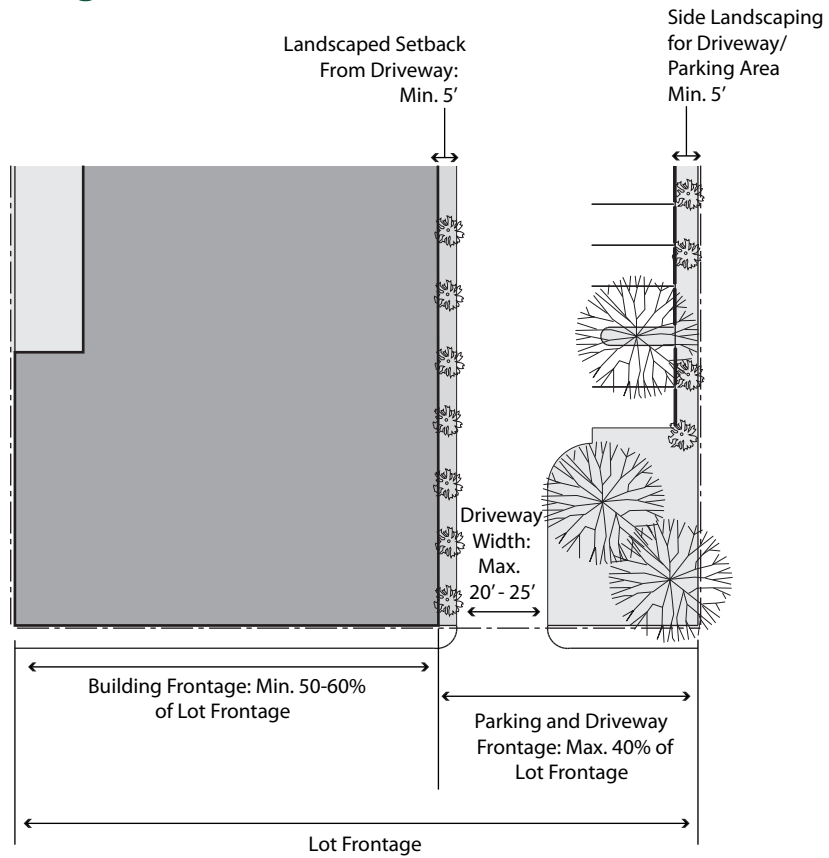
**Figure 4.2-2: Residential Mixed Use: Street Elevation**



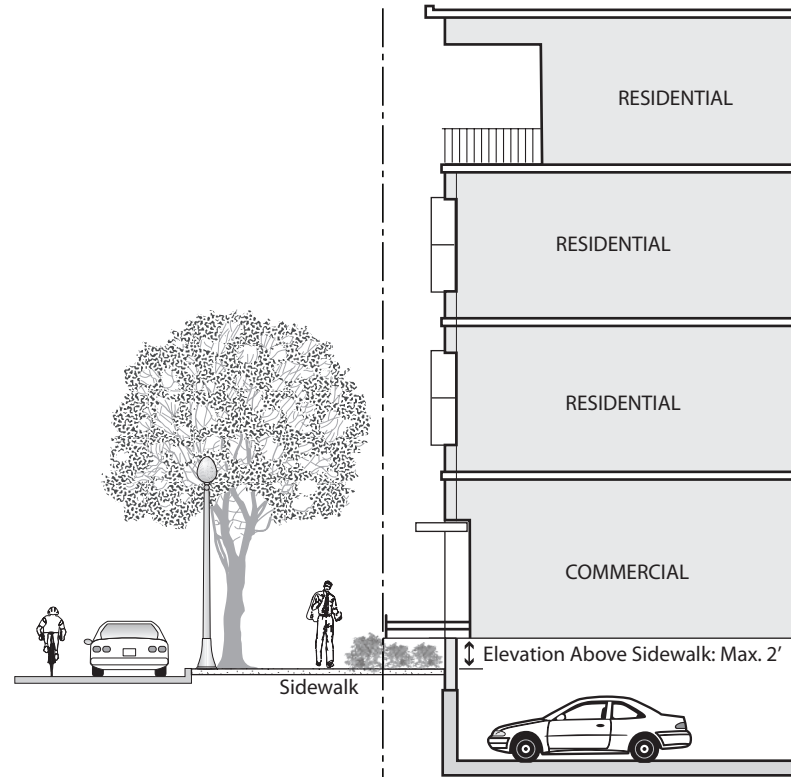
**Figure 4.2-3: Residential Mixed Use: Setbacks for Primary Windows**



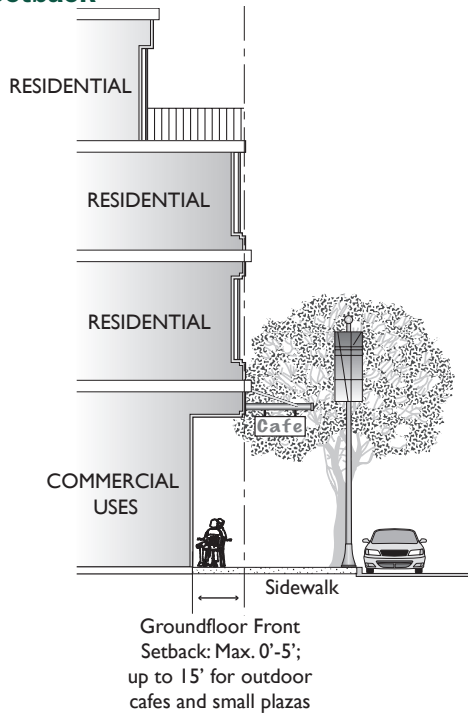
**Figure 4.2-4: Residential Mixed Use: Frontages**



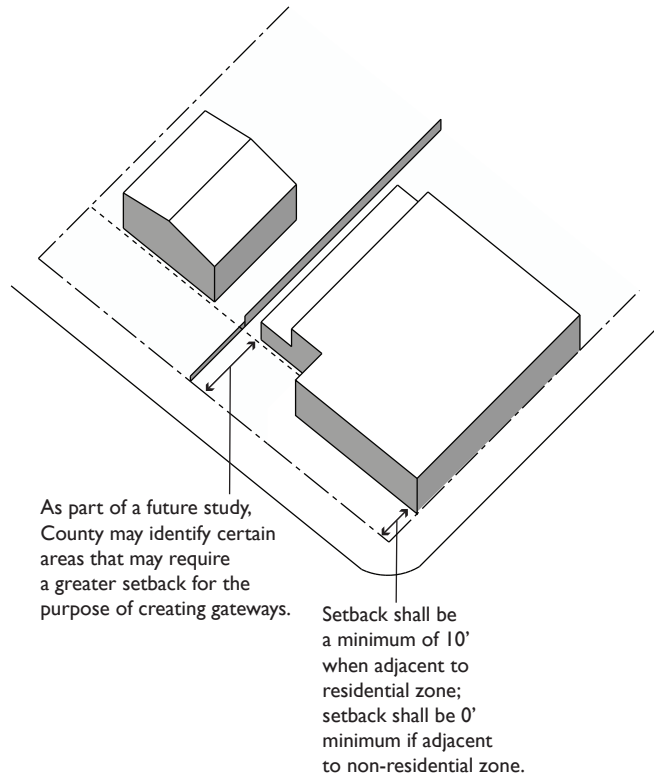
**Figure 4.2-5: Residential Mixed Use: Commercial Elevation Above Sidewalk**



**Figure 4.2-6: Residential Mixed Use: Front Setback**

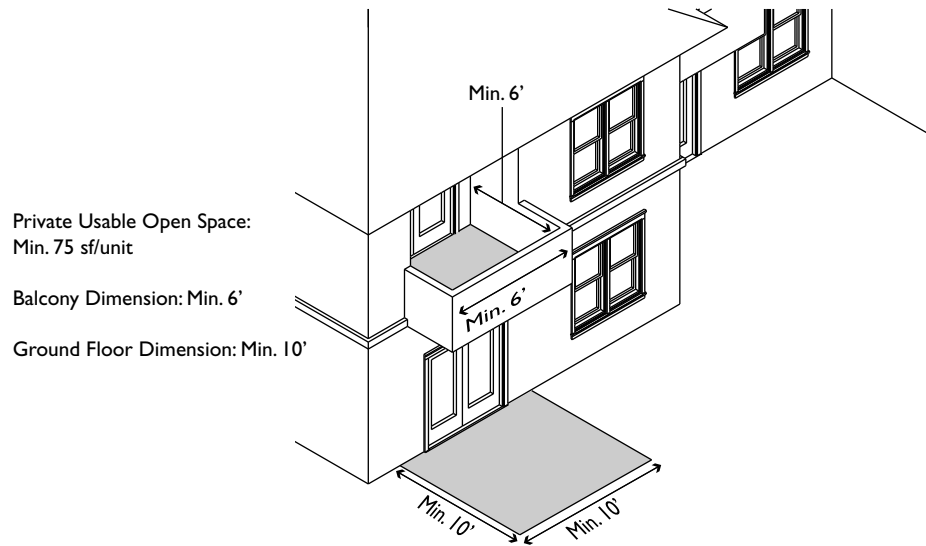


**Figure 4.2-7: Residential Mixed-Use: Street Front Setback Adjacent to Residential**

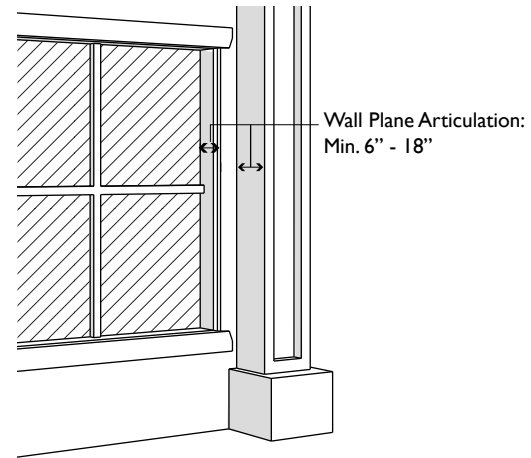




**Figure 4.2-8: Residential Mixed Use: Open Space**

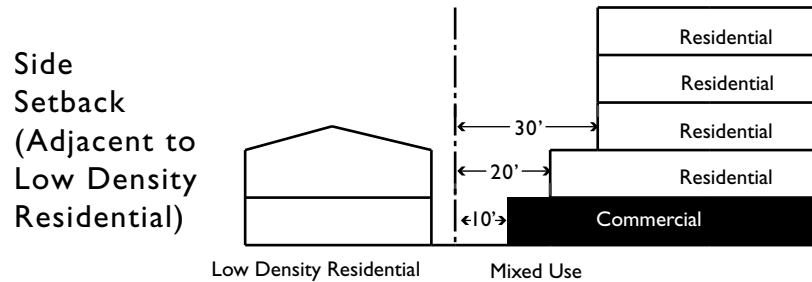
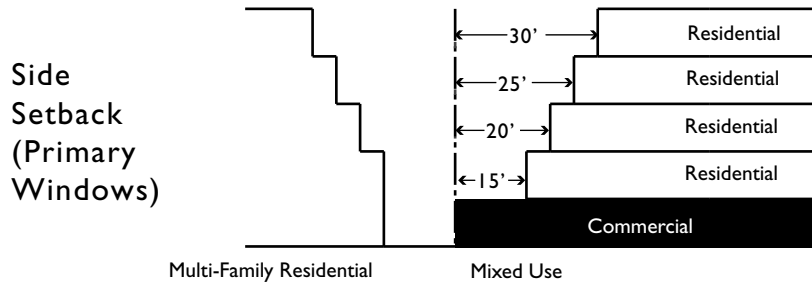
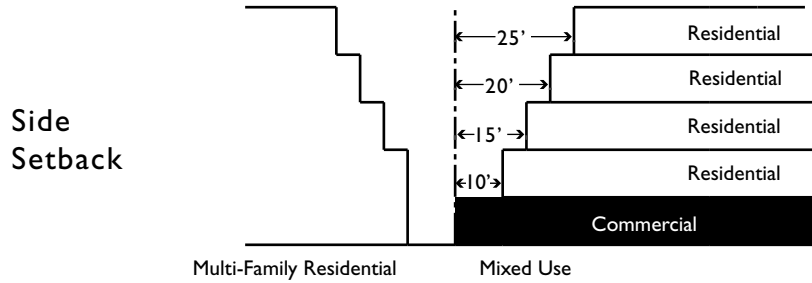


**Figure 4.2-9: Residential Mixed Use: Ground Floor Wall Plane Articulation**

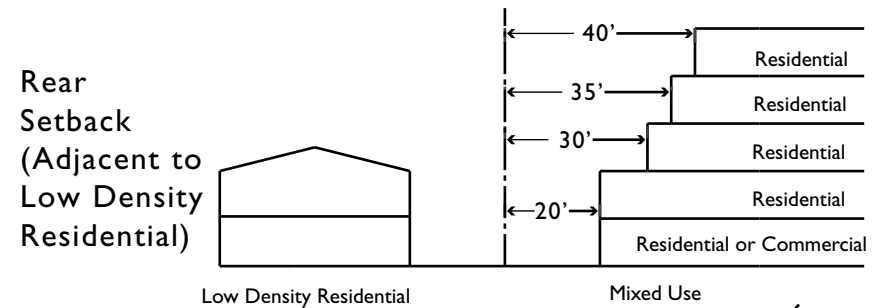
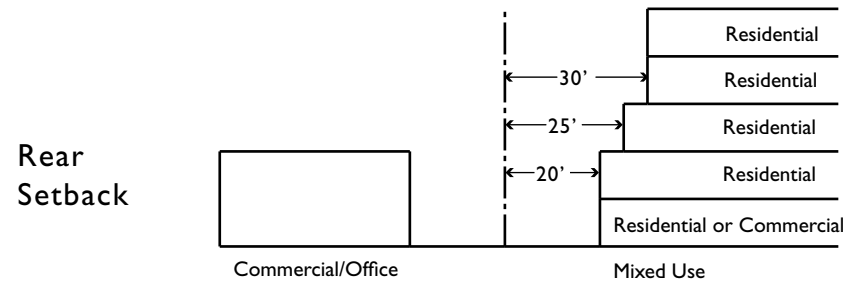


**Figure 4.2-10: Residential Mixed Use: Side and Rear Setbacks**

**SIDE SETBACK**



**REAR SETBACK**



**Figure 4.2-11: Residential Mixed Use: Height Projections and Façade**



*Page Intentionally Left Blank*

**TABLE 4.2-1: RESIDENTIAL MIXED-USE STANDARDS**

ACBD: Ashland and Cherryland Business District / CVCBD: Castro Valley Central Business District						
<b>Standard</b>	<b>CVCBD Land Use Group D (Subarea 2,4,5,6,7)</b>	<b>CVCBD Land Use Group E (Subarea 8,9,10,11)</b>	<b>ACBD-TA</b>	<b>ACBD-TC, ACBD-FA (E. 14th, Mission)</b>	<b>ACBD-RC, ACBD-FA (Lewelling)</b>	<b>Additional Standards</b>
<b>DEVELOPMENT INTENSITY AND NEIGHBORHOOD COMPATIBILITY</b>						
Minimum Building Site (sq ft)	10,000 - 20,000	20,000				
Minimum Lot Frontage (ft)	100	100	100	100	100	
Maximum Density (dwelling units/net acre)	17.4 - 21.8; 20 - 40	40 - 60	50	See General Plan	15 - 25	For CVCBD Land Use Group D, 20-40 du/ac is allowed in special circumstances. See Mixed-Use CVCBD Land Use Group D in Table 4.1-1. For ACBD-FA, see General Plan
Minimum Area per Dwelling Unit (sq ft)	2,500 - 2,000					For CV-CVBD Land Use Group D: 2,500 with minimum lot size of 10,000 – 20,000 sq ft 2,000 with minimum lot size of > 20,000 sq ft See Mixed-Use CVCBD Land Use Group D in Table 4.1-1.
Minimum Overall FAR			0.75			
Maximum Lot Coverage (%)	70	70	70	70	70	
<b>COMMERCIAL USES</b>						
Commercial Uses	Commercial uses are required along the street frontage in the areas specified in the Specific Plans for continuous pedestrian-oriented shopping areas. On such street segments, locate residential units above ground floor commercial uses, or behind a commercial building that fronts the street.					
Minimum Ground Floor Commercial Space (% of ground floor space)			50			Exceptions to the minimum ground floor retail requirement may be approved by Staff for long deep lots if ground floor retail occupies at least 60 percent of the linear street frontage, and tenant spaces have a minimum width of 25 feet and a minimum depth of 60 feet.

Table 4.2-1: Residential Mixed-Use Standards

ACBD: Ashland and Cherryland Business District / CVCBD: Castro Valley Central Business District						
<b>Standard</b>	<b>CVCBD Land Use Group D (Subarea 2,4,5,6,7)</b>	<b>CVCBD Land Use Group E (Subarea 8, 9,10,11)</b>	<b>ACBD-TA</b>	<b>ACBD-TC, ACBD-FA (E. 14th, Mission)</b>	<b>ACBD-RC, ACBD-FA (Lewelling)</b>	<b>Additional Standards</b>
<b>BUILDING HEIGHT AND FORM</b>						
Maximum Height (ft)	45	45	45	45	35	In CVCBD, all buildings with heights greater than two stories or thirty feet must demonstrate through the Site Development Review process that they frame or complement, rather than block, view corridors and that they enhance, rather than obscure, significant topographic features or adjacent development.
Height Exception	50	55	55	55	-	Additional height for portions of buildings in the center of the property at least 25 feet away from property lines (or more if required by setbacks)
Height Exception (For Projections)	Non-habitable building features such as chimneys (up to 6' in width), cupolas, flagpoles, monuments, steeples, roof screens, equipment, and similar structures, covering no more than 10% of the top floor roof area to which they are accessory, may exceed maximum permitted height standards by up to 8'.					See Figure 4.2-11.
Maximum Stories	3	4	4	4	3	
Stories Exception	4	5	5	5	-	Additional stories for portions of buildings in the center of the property, at least 25 feet away from property lines (or more if required by setbacks).
Maximum Floor Area (% of First Story Building Footprint Area)	First Story: 100% Second Story: 90% Third Story: 80% Fourth Story: 75% Fifth Story (if allowed): 75%					
Maximum Building Length (ft)	150	150	150	150	150	Exceptions may be approved by Staff if buildings are designed with many different setbacks (instead of a long flat wall), changes in roof form or height, and major recesses (notches) along the length of the building, which successfully break up the massing of the building. Parking podiums may be continuous.

Table 4.2-1: Residential Mixed-Use Standards

ACBD: Ashland and Cherryland Business District / CVCBD: Castro Valley Central Business District						
<b>Standard</b>	<b>CVCBD Land Use Group D (Subarea 2,4,5,6,7)</b>	<b>CVCBD Land Use Group E (Subarea 8, 9,10,11)</b>	<b>ACBD-TA</b>	<b>ACBD-TC, ACBD-FA (E. 14th, Mission)</b>	<b>ACBD-RC, ACBD-FA (Lewelling)</b>	<b>Additional Standards</b>
<b>BUILDING RELATIONSHIP TO THE STREET</b>						
Minimum Building Frontage (%)	60	60	60	60	60	A building is required to occupy a minimum of 60 percent of the lot frontage. A <i>minimum frontage of 50 percent may be acceptable in ACBD-TC.</i>
Elevation Above Sidewalk Level (ft) (exceptions without variance through public hearing design review process).						
Minimum for Ground Floor Living Space (ft)	2	2	2	2	2	
Maximum for Ground Floor Living Space (ft)	5	5	5	5	5	
Maximum for Ground Floor Commercial (ft)	2	2	2	2	2	Applies to the commercial portion of the building that fronts the sidewalk. See Figure 4.2-5.
Minimum Commercial Street Wall Height (ft)			25	25	25	<i>Minimum height for commercial buildings at or near the street frontage shall be 25 feet, measured to the top of the façade. For single story buildings, a false front or parapet can be used to achieve this minimum height. Where exterior frontage height varies along the building frontage, the minimum height shall be considered to be the average height of the building frontage.</i>
Minimum Ground Level Floor to Ceiling Height (ft)						See Figure 4.2-11.
Retail	15	15	15	15	15	
Office	12	12	12	12	12	
<b>COMMERCIAL GROUND FLOOR BUILDING DESIGN</b>						
Maximum Ground Floor Blank Walls (%)	25	25	25	25	25	No more than 25 percent of the ground level wall area directly visible from the street shall be left blank. The ground level wall area is defined as that portion of the building elevation from grade to a height of 9 feet.
Maximum Ground Floor Blank Walls (horizontal feet)	25	25	25	25	25	

Table 4.2-1: Residential Mixed-Use Standards

ACBD: Ashland and Cherryland Business District / CVCBD: Castro Valley Central Business District						
<b>Standard</b>	<b>CVCBD Land Use Group D (Subarea 2,4,5,6,7)</b>	<b>CVCBD Land Use Group E (Subarea 8, 9,10,11)</b>	<b>ACBD-TA</b>	<b>ACBD-TC, ACBD-FA (E. 14th, Mission)</b>	<b>ACBD-RC, ACBD-FA (Lewelling)</b>	<b>Additional Standards</b>
Minimum Glazing (%)	50	50	50	50	50	Clear glass display windows and entries must comprise a minimum of 50 percent of the ground level wall area.
Minimum Entrances (number per 100 ft)	1	1	1	1	1	
Minimum Wall Plane Articulation (inches)	Ground floor wall plane articulation is required to be a minimum 6 to 18 inches. Windows, doors, columns, and other features should be recessed or project forward, such that there is a six-inch difference between wall and window surfaces and a total of at least 18 inches from the window to the outermost plane of a wall or column. See Figure 4.2-12.					
<b>SETBACKS FOR LIGHT, AIR AND PRIVACY</b>						
Minimum Setbacks (ft)						See Figure 4.2-10.
Minimum Front (Commercial Uses)	Buildings shall be located between 0 and 5 feet from street-facing property line. A setback of up to 15 feet is allowed for outdoor cafes and small plazas.					
Minimum Street Front (Commercial Uses, Adjacent to Residential District)	Minimum 10 feet. As part of a future study, the County may identify certain areas that may require a greater setback for the purpose of creating gateways at select intersections.					Must be landscaped. The maximum height of a fence or solid masonry wall between the residential front lawn setback and the required landscaped setback for the adjacent commercial frontage shall be 3 feet.
Minimum Front (Ground Floor Residential Uses)	20					Minimum front yard setback shall be 20 feet where residential uses are included on the ground floor along a commercial or mixed-use corridor, including East 14th Street and Castro Valley Boulevard.



Table 4.2-1: Residential Mixed-Use Standards

ACBD: Ashland and Cherryland Business District / CVCBD: Castro Valley Central Business District						
<b>Standard</b>	<b>CVCBD Land Use Group D (Subarea 2,4,5,6,7)</b>	<b>CVCBD Land Use Group E (Subarea 8, 9,10,11)</b>	<b>ACBD-TA</b>	<b>ACBD-TC, ACBD-FA (E. 14th, Mission)</b>	<b>ACBD-RC, ACBD-FA (Lewelling)</b>	<b>Additional Standards</b>
Minimum Side (Commercial Uses)	0' if adjacent to non-residentially zoned property; 10' if adjacent to residentially zoned property		For ACBD, commercial development adjacent to residentially zoned property shall provide a minimum 10 foot landscape setback, excluding that portion of the side property line that is within the street frontage setback			Ground floor commercial development may have a 0 foot side setback, for the first floor, for the first 60 feet of depth.  For ACBD, the side property landscaped setback shall include tree planting, to provide a continuous shade canopy against the building wall when viewed from the residential property. A maximum tree spacing of 20-40 feet should be provided, depending on the species of tree selected.
Minimum Side (Residential)	First Story: 10 Second Story: 10 Third Story: 15 Fourth Story (if allowed): 20 Fifth Story (if allowed): 25					
Minimum Side (For Walls Containing Living Room or Other Primary Room Windows)	First Story: 15 Second Story: 15 Third Story: 20 Fourth Story (if allowed): 25 Fifth Story (if allowed): 30					These setbacks shall apply for any wall containing living room or other primary room windows. When the site is adjacent to a R-1 or R-S District, the project must comply with whichever standard results in the greater setback.
Minimum Side (Adjacent to R-1 or R-S District)	First Story: 20 Second Story: 20 Third Story: 30 Fourth Story (if allowed): 30 Fifth Story (if allowed): 30					
Minimum Rear ( <i>Not</i> adjacent to R-1 or R-S)	First Story: 20 Second Story: 20 Third Story: 25 Fourth Story (if allowed): 30 Fifth Story (if allowed): 30					

Table 4.2-1: Residential Mixed-Use Standards

ACBD: Ashland and Cherryland Business District / CVCBD: Castro Valley Central Business District						
<b>Standard</b>	<b>CVCBD Land Use Group D (Subarea 2,4,5,6,7)</b>	<b>CVCBD Land Use Group E (Subarea 8, 9,10,11)</b>	<b>ACBD-TA</b>	<b>ACBD-TC, ACBD-FA (E. 14th, Mission)</b>	<b>ACBD-RC, ACBD-FA (Lewelling)</b>	<b>Additional Standards</b>
Rear (Adjacent to R-1 or R-S District)	First Story: 20 Second Story: 20 Third Story: 30 Fourth Story (if allowed): 35 Fifth Story: (if allowed) 40					
Minimum Setback From Access Driveway (ft)	5	5	5	5	5	Must be landscaped
Minimum Distance Between Buildings (ft)	The minimum distance between buildings shall be 10 feet. The minimum distance shall be increased by 10 feet for each additional story.					
<b>AUTO CIRCULATION: SITE ACCESS AND DRIVEWAYS</b>						
Maximum Access Driveway Width (ft)	20	20	20	20	20	Staff may approve up to 25 feet for high density development on busy streets.
Maximum Curb Cuts (number per lot)	1	1	1	1	1	Exception may be granted by Staff if lot exceeds one acre, lot frontage exceeds 200 feet, or through lot.
Minimum Spacing Between Curb Cuts (ft)			75	50		
Maximum Driveway Gates Setback (ft)	40	40	40	40	40	Gates are strongly discouraged. Gates across driveways shall be set back a minimum of 40' behind the property line, or greater depending on location in State Responsibility Fire Area and street travel speed.
<b>PARKING LOCATION AND DESIGN</b>						
Maximum Frontage of Parking and Driveways (% of lot frontage)	40	40	40	40	40	
Maximum Frontage of Parking (% of lot frontage)	30	30	30	30	30	

Table 4.2-1: Residential Mixed-Use Standards

ACBD: Ashland and Cherryland Business District / CVCBD: Castro Valley Central Business District						
<b>Standard</b>	<b>CVCBD Land Use Group D (Subarea 2,4,5,6,7)</b>	<b>CVCBD Land Use Group E (Subarea 8, 9,10,11)</b>	<b>ACBD-TA</b>	<b>ACBD-TC, ACBD-FA (E. 14th, Mission)</b>	<b>ACBD-RC, ACBD-FA (Lewelling)</b>	<b>Additional Standards</b>
Commercial Parking (space per 1,000 sq ft)	See Zoning Ordinance	See Zoning Ordinance	3.5 Maximum	2 (retail development > 2,500 sq ft)	See Zoning Ordinance	For ACBD-TC, parking for commercial and office can be met by on-street spaces to a maximum of 2,500 sq ft of lease space.  For ACBD-FA, parking for retail and office uses are 4 per 1,000 square feet. On street spaces can supplement this requirement.  For CVCBD, lots consisting of more than eight spaces must provide at least 25 percent but not more than 50 percent compact spaces.
Unit Parking (space per unit)	Studio: 1 1-bdrm: 1.5, 2-bdrm+: 2	Studio: 1 1-bdrm: 1.5, 2-bdrm+: 2	1 Minimum; 1.1 Maximum	1 Minimum; 1.25 Maximum	Studio: 1 1-bdrm: 1.5, 2-bdrm+: 2	Minimum of one space must be covered. Tandem parking allowed for up to 25 percent of the units.  For CVCBD, lots consisting of more than eight spaces must provide at least 25 percent but not more than 50 percent compact spaces.  For ACBD-FA, the residential parking requirement shall be as follows: Studio: 1; 1-bdrm: 1.5; 2-bdrm+: 2
Transit Corridor Exception	Allow reduced parking for projects that are ½ mile from transit stations of ¼ mile from major transit corridors, through a discretionary review process that includes public notice and opportunity for public input. Transit stations are defined as a BART station, light rail station, or other heavy rail transit station. Major transit corridors are defined as bus corridors with bus rapid transit or corridors with bus service at least every 15 minutes during peak hours and every 30 minutes during daytime hours. Reduced parking may not be allowed if there is existing parking congestion, as defined by the Planning Director, on the street. A parking study may be required to determine existing parking congestion.					

Table 4.2-1: Residential Mixed-Use Standards

ACBD: Ashland and Cherryland Business District / CVCBD: Castro Valley Central Business District						
<b>Standard</b>	<b>CVCBD Land Use Group D (Subarea 2,4,5,6,7)</b>	<b>CVCBD Land Use Group E (Subarea 8,9,10,11)</b>	<b>ACBD-TA</b>	<b>ACBD-TC, ACBD-FA (E. 14th, Mission)</b>	<b>ACBD-RC, ACBD-FA (Lewelling)</b>	<b>Additional Standards</b>
Guest Parking (space per unit)	0.25	0.25	0	0; must allow residential guest parking in commercial spaces during non-peak hours	0.25	Shared parking allowed only if there is an opportunity for shared parking between commercial and residential uses. Shared parking is based on the accessibility of parking to business patrons and residential visitors and based on peak hours of commercial business operations. If there is no such opportunity, additional guest parking may be required.  For ACBD-FA, the guest parking requirement shall be 0.25 per unit.
<b>FACILITIES FOR PEDESTRIANS, BICYCLES, AND TRANSIT</b>						
Minimum Decorative Driveway Paving (% of Driveway and Parking Area)	10					Locate at driveway entrance, and in areas that can be used as open space.
Bicycle Parking	Required. See Chapter 6: Bicycle Parking Standards					
Transit Shelters	On sites that abut a transit corridor (with bus service at least every 15 minutes during peak hours and every 20 to 30 minutes during daytime hours), as requested by the transit agency.					
Public Right-of-Way Improvements	See Specific Plans and Alameda County Engineering Guidelines					
<b>SITE LANDSCAPING</b>						
Minimum Site Landscaping (%)	20	20	20	20	20	A minimum site landscaping of 10 percent may be acceptable in ACBD-FA.
Minimum Driveway and Parking Area Side Landscaping (ft)	5	5	5	5	5	Applies between the driveway/parking areas and the side and rear property lines.
Minimum Parking Area Landscaping	See Chapter 6: Parking Area Landscaping					
<b>USABLE OPEN SPACE</b>						
Minimum Total Usable Open Space (sq ft per unit)	300	300	300	300	300	

Table 4.2-1: Residential Mixed-Use Standards

ACBD: Ashland and Cherryland Business District / CVCBD: Castro Valley Central Business District						
<b>Standard</b>	<b>CVCBD Land Use Group D (Subarea 2,4,5,6,7)</b>	<b>CVCBD Land Use Group E (Subarea 8, 9,10,11)</b>	<b>ACBD-TA</b>	<b>ACBD-TC, ACBD-FA (E. 14th, Mission)</b>	<b>ACBD-RC, ACBD-FA (Lewelling)</b>	<b>Additional Standards</b>
Minimum Common Usable Open Space (sq ft)	1,000 square feet, no less than 100 sq ft per unit.					Common space buildings or covered structures cannot occupy more than 20 percent of common open space.
Minimum Dimension (ft)	25	25	25	25	25	
Minimum Private Usable Open Space (sq ft per unit)	75	75	75	75	75	Up to 20 percent of units may not be required to provide private usable open space if they are close to common usable open space and the common usable open space exceeds the minimum required.  Private open space must be open air, not fully enclosed with walls. Private open space cannot be covered by a roof by more than 50 percent of the area; however balconies can have up to 100 percent ceiling coverage.  See Figure 4.2-8.
Minimum Ground Floor Dimension (ft)	10	10	10	10	10	
Minimum Balcony Dimension (ft)	6	6	6	6	6	
<b>STORAGE</b>						
Storage Areas	Required for all units.					
Minimum Area (cubic ft per unit)	100 cu ft, plus 75 cu ft bedroom with maximum 250 cu ft total required.					
Minimum Dimension (ft)	8	8	8	8	8	

*Page Intentionally Left Blank*

# 5

# DESIGN GUIDELINES FOR RESIDENTIAL MIXED-USE PROJECTS

The Residential Mixed-Use Guidelines provide specific and broad recommendations to create high quality buildings and site plans that will result in attractive, livable, and pedestrian-friendly mixed-use districts. They aim to be prescriptive enough to create a framework for design and carry out the community's urban design vision but flexible enough to allow for creativity and innovation in design and planning. This Chapter presents Design Guidelines on the following topics:

- A. Development Intensity
- B. Location of Commercial and Residential Uses
- C. Building Height and Form
- D. Building Relationship to the Street
- E. Building Design
- F. Building Setbacks for Light, Air and Privacy
- G. Auto Circulation: Site Access, Streets and Driveways
- H. Parking Location and Design
- I. Facilities for Walking, Bicycle, Transit
- J. Site Landscaping
- K. Usable Open Space
- L. Fences and Walls
- M. Services



## A. DEVELOPMENT INTENSITY

These guidelines ensure that projects contribute to the appearance and vitality of the mixed-use districts and respect the unique features of adjoining properties.

- A-1 Design projects to enhance the visual appearance of the street and district in which they are located.
- A-2 Locate and orient buildings to respect the need for privacy, light, and air of surrounding structures, especially adjoining low and medium density residential development.

### DESIRABLE



*This project provides architectural interest and enhances the visual appearance of the street. (Guideline A-1)*

### DESIRABLE



*The taller stories of this project are located in the middle of the project which minimizes the impact of the project on adjacent neighboring property. (Guideline A-2)*

## DESIRABLE



*These active commercial uses on the ground floor, including restaurant and retail, adjacent to the sidewalk create a lively pedestrian realm. (Guideline B-1)*

## DESIRABLE



*Continuous storefront windows and frequent, highly visible entrances along this street provides visual interest and promotes walkability. (Guideline B-2)*

## DESIRABLE



*This open air store frontage brings the retail activity to the street, engaging pedestrians who walk by. (Guideline B-2)*

## B. LOCATION OF COMMERCIAL AND RESIDENTIAL USES

These guidelines ensure that the ground floor commercial uses create an active pedestrian realm, that is an engaging and well-populated environment with a variety of uses and activities.

- B-1** Locate active commercial uses on the ground floor adjacent to the sidewalk, including retail, restaurant, and personal service uses.
- B-2** Provide continuous storefront windows, open air store frontages, and frequent, highly visible entrances for ground floor commercial uses adjacent to the street and sidewalk.

## ACBD

- B-3** In ACBD-TC and ACBD-TA, locate buildings at or near the property line. Ground floor street frontage space is to be predominantly for active, pedestrian-oriented uses.
- B-4** In the ACBD, the residential component of mixed-use development adjacent to residential property shall be located to be functionally a part of the residential area. For example, primary access to the residential units shall be from the residential street, and residential units shall have view access to the adjacent residential neighborhood.

## C. BUILDING HEIGHT AND FORM

### Building Height

The purpose of these limits is to ensure that the scale of the building is compatible, and tall buildings are not located so as to overwhelm smaller scale buildings or block access to light and sun.

- C-1** Locate the taller portions of residential projects away from adjoining residential properties, in order to provide height transitions between taller and lower buildings, and to maximize light, air, and privacy for units.
- C-2** For projects adjacent to low and medium density residential zones, reduce the visual and shadow impact of upper stories by using one or more of the following design strategies:
- Locate upper floors in the center of the property at least 30 feet away from adjacent properties,
  - Step back the top one or two stories from the stories below.
  - Tuck the top story inside a pitched roof,
  - Use pitched roofs with dormer windows for top story rooms.

### DESIRABLE



*In this project, two-story units provide a transition between the taller portion of the project and adjacent neighboring property. (Guideline C-1)*

### UNDESIRABLE



*In this project, the lack of step backs produces a bulky project that overwhelms the neighboring single-family property. (Guideline C-1)*

## DESIRABLE



*In this project, breaking up the building into smaller discrete masses minimizes the bulk of the building. (Guideline C-5)*

## DESIRABLE



*The building bulk is broken up through height recesses along the length of the building. (Guideline C-5)*

## DESIRABLE



*The corner of this building is marked with an architectural element, which provides visual orientation from major commercial arterials. (Guideline C-7)*

## Building Form and Bulk

These guidelines ensure that continuous buildings with attached or stacked units on deep narrow lots do not end up being overly long and bulky, creating an incompatible institutional character within residential neighborhoods.

- C-3** Design residential projects to avoid large box-like forms with continuous unrelieved surfaces.
- C-4** Include articulation in the project, such that the bulk as seen from existing neighbors is reduced. (See Building Articulation.)
- C-5** Minimize the bulk of the buildings by limiting building length, or designing buildings with two or more of the following special features to break up building bulk, including:
  - Horizontal and vertical setbacks and step-backs (instead of a long flat wall);
  - Changes in roof form and height;
  - Major full-height recesses (typically at least 10 feet deep) along the length of the building that successfully break the building into smaller discrete masses.
- C-6** Ground level parking podiums and lobbies can be continuous without a break if the above guidelines are met.
- C-7** Provide visual orientation from the major commercial arterials through graduated heights and/or varied setbacks or architectural elements such as towers to mark entries or corners to reduce the scale of larger buildings and to provide visual orientation from the major commercial arterials.

## D. BUILDING RELATIONSHIP TO THE STREET<sup>1</sup>

These guidelines ensure that projects strengthen the pedestrian realm, foster pedestrian comfort, and emphasize neighborhood character.

### Pedestrian-Oriented Areas

- D-1** Locate active uses on the ground floor, and provide continuous storefront windows and frequent, highly-visible entries.
- D-2** Locate buildings close to the sidewalk, to enclose the public realm of the street and sidewalk, and locate shops and restaurants next to the pedestrian sidewalk. Wider setbacks are appropriate to allow for the following:
- Wider sidewalks where they are narrow;
  - Building entrances and facade articulation;
  - Outdoor cafes;
  - Plazas or other high activity public areas.
- D-3** Design setback areas to be used for public entry, gathering and outdoor commercial activity. Design them predominantly with hardscape, and provide shade and places to sit. They also may be appropriate places to locate pedestrian conveniences such as public telephones, trash receptacles, bicycle racks and newspaper dispensers
- D-4** Minimize the visibility of parking from the street and sidewalk, especially at corners. Locate parking to the side or rear of buildings, or underground.

1. See Endnote

### DESIRABLE



*This building is located close to the sidewalk, enclosing the public realm of the street and sidewalk. (Guideline D-2)*

### DESIRABLE



*Active uses on the ground floor animate the pedestrian realm and promote walkability. (Guideline D-1)*

## DESIRABLE



Landscaping, trees, and a low wall help to ensure that the visual definition of the street edge is maintained. (Guideline D-5)

## DESIRABLE



In CVCBD, when a property located along Castro Valley Boulevard, Redwood Road, or Lake Chabot Road is not built out to the front property line, and where a landscape setback exists or is created, provide a second row of the designated street trees as part of the site landscaping. (Guideline D-6)

## Other Areas

- D-5 In areas where building frontage is allowed to be set back from the street, provide a substantial landscape zone between the sidewalk and the parking area to ensure that the visual definition of the street edge is maintained. Recommended design elements, in addition to tree planting, include low walls, raised planters, and small commercial use buildings or kiosk structures.
- D-6 In CVCBD, when a property located along Castro Valley Boulevard, Redwood Road, or Lake Chabot Road is not built out to the front property line, and where a landscape setback exists or is created, provide a second row of the designated street trees as part of the site landscaping.
- D-7 Arrange buildings located off of the street, such as at the rear edge of the site, in related groups or organized around plazas or internal circulation nodes. In addition, the site design needs to indicate a direct response to adjacent development in order to facilitate pedestrian and vehicular movement between sites and building.

## Doors and Entrances

- D-8 Emphasize building entrances with special architectural and landscape treatments. Low quality trim materials, such as anodized aluminum, are not permitted for window and door trim.
- D-9 Locate all customer entries and entryways to be directly visible from the public sidewalk, and accessible from public and private walkways. Corner buildings are encouraged to have corner entries.
- D-10 Provide a pedestrian walkway from the public sidewalk to the entry frontage of buildings set back from the street edge.
- D-11 Design public street facing residential facades with individual entries, such as steps, porches, and paths from living units to the street help to break down the scale of multi-unit buildings.
- D-12 Provide attractive rear and side access to businesses where there is parking at the rear or side of the site, but in all cases, there must be a principal entry that is strong and visible from the public sidewalk.

### DESIRABLE



*The special treatment of the awning highlights the entrance of the building. (Guideline D-8)*

### DESIRABLE



*This customer entry is directly visible and accessible from the public sidewalk, which strengthens the pedestrian realm. (Guideline D-9)*

## DESIRABLE



*This project exhibits consistent design integrity, as the building components are in keeping with the Art Deco style. (Guideline E-1)*

## DESIRABLE



*This ground floor storefront consist of clear glass display windows and a glass entry, allowing pedestrians to see inside the space. (Guideline E-4)*

## E. BUILDING DESIGN

These guidelines seek to create unified and harmonious building compositions, promote quality architecture, and visual diversity. No official architectural style is dictated or preferred.

### Architectural Style

- E-1** Design projects with a consistent design integrity, exhibited by all building components including, but not limited to, building mass and articulation, roof forms, windows (proportion and design), building materials, facade details (doors and entrances), fencing, and landscaping.
- E-2** Design publicly-visible exterior facades, or building walls to be substantial, permanent, and integral to the entire building.

### Building Design

- E-3** Organize facade areas to provide:
  - Horizontal emphasis through recesses, ornamentation and other types of decorative detail;
  - Pedestrian orientation through overhangs, eaves, awnings, display windows and architectural ornamentation; and
  - Harmonious composition through use of complementary combinations of materials and colors.
- E-4** Design commercial building facades fronting on sidewalks to consist of storefronts that include a preponderance of clear glass display windows and entry doors, that provide visibility into the ground floor lease space.
  - In some circumstances, such as when building security would be placed at risk or when a side or rear wall of a building is adjacent to or near the street, shallow display windows, containing merchandise or artworks, are encouraged.
  - Ground floor office uses are discouraged, per the Land Use Element of the Specific Plans, but, where present, must be designed and maintained as storefront spaces.
- E-5** Include architectural elements providing shade and weather protection for pedestrians, such as overhangs and arcades.



## Building Materials

- E-6 Use building materials that convey a sense of durability and permanence. Use high quality materials that will last for the life of the building. Install materials so that building facades do not stain or deteriorate quickly.
- E-7 Use the highest quality and most durable materials at the ground floor of buildings, because those can be most impacted by landscaping, people, and automobiles. Ground floor exterior materials must be tile, stone, brick, glass, concrete, and other highly durable materials. Do not use stucco or EIFS in the first three feet above sidewalk level.
- E-8 Use exterior siding materials such as stucco, wood siding, masonry, tile, wood shingles, metal panels, and glass panels. Do not use scored plywood, aluminum siding, or shake or wood shingles.
- E-9 Use a complementary palette of materials on all four sides of buildings. Use building materials of similar durability and quality throughout the project.
- E-10 Locate material changes at interior corners as a return at least six feet from the external corners or other logical terminations; and not at external corners.
- E-11 Use secondary materials (such as ceramic tile, terra cotta, or wood millwork) applied to the primary finish material that are complementary to the primary material and compatible with the overall building design. Do not use false stone, plastic, aluminum, or plywood.
- E-12 Finish any blank building walls adjacent to and visible from residential properties with quality materials; and maintain them free of any signs or graffiti.

- E-13 Where they are visible from the street or adjacent to pedestrian walkways, design the blank sides and backs of buildings to provide visual interest by making use of such elements as recesses, bays, covered walkways, or shallow display windows. Highly textured materials that provide contrasts of shade and light or murals are other appropriate design solutions for otherwise blank walls that are visible to adjacent uses. (Murals are considered public art and would require a public hearing.)

## DESIRABLE



*These buildings use brick and other high quality materials that convey a sense of permanence. (Guideline E-6)*

## DESIRABLE



*This project uses tile for the first three feet above the sidewalk level, which is highly durable and adds a decorative element to the ground floor design. (Guideline E-7)*

## DESIRABLE MUTED COLORS



Although this project incorporates several colors into its facade, it does so successfully as the colors are harmonious with each other. (Guideline E-14)

## DESIRABLE MUTED COLORS



The green and yellow colors on this facade serve as accent colors, rather than being used for the entire facade. (Guideline E-15)

## Building Colors

- E-14 Select a coordinated palette of complimentary colors, rather than a patchwork of competing colors.
- E-15 Use bright and/or dark colors only as accent colors.
- E-16 Do not use fluorescent or neon colors.

## ACBD

- E-17 Integral color exterior building materials are preferred, whenever possible, for new buildings or for exterior remodellings, and such materials should not be painted, with the exception of integral color stucco or comparable materials, which may require long term repaintings. Wood siding is a traditional exterior building material, which does require painting for weather protection, as do certain other materials over time.
- E-18 Use exterior paint schemes for that are compatible or harmonious with other colors within any particular business district.

## CVCBD

- E-19 Use predominant building colors that are generally light in tone. (This does not restrict the color palette to any one color range, such as earth tones.) Avoid Corporate colors not consistent with this or other guidelines on color. Darker colors may be used for trim.
- E-20 Use muted colors for large areas such as building walls.
- E-21 Wood siding and trim may be left natural and stained to be light in tone.
- E-22 Use a consistent color scheme for a building's entire facade and all visible sides.
- E-23 Use a color scheme that is compatible with the

colors of adjacent buildings, unless the colors of adjacent buildings strongly diverge from these Design Guidelines. In such a case, the Guidelines shall prevail.

- E-24 Wherever possible, limit the number of colors appearing on the building exterior to no more than three colors or tones of the same color, including trim and accent colors.
- E-25 Use architectural detailing, including the use of color, that complements and embellishes principal design features, materials and colors of a building facade.

## Building Articulation

**E-26** Design window recesses, window trim, doorways, columns, overhangs and other architectural elements to be substantial in depth, in order to create shadow and architectural relief. Incorporate at least three and typically four of the following features that provide articulation and design interest, on all sides of buildings:

- Minimum depth of at least two inches from glass to exterior of trim or wall edge around windows;
- Decorative trim elements that add detail and articulation, such as window and door surrounds with at least a two-inch depth; or deeply recessed windows (more than two inches). They must be designed as an integral part of the design, and not appear “tacked-on;”
- Pitched / variegated roof forms;
- Roof overhangs at least 18 inches deep;
- Variety in use of materials, especially at ground level stories, for detailing at building entrances or other special parts of the building;
- Building base (typically bottom three feet) that is faced with a stone or brick material, or is delineated with a channel or projection; and/or
- Railings with a design pattern in wood, metal, or stone.

### DESIRABLE



*This facade incorporates projections and other articulation elements throughout the façade design which adds architectural interest and a visual play of light and shadow. (Guideline E-26 & 27)*

### DESIRABLE



*The facade is articulated to break the project down to smaller components and reduces bulk. (Guideline E-26 & 27)*

### UNDESIRABLE



*Although this project incorporates several articulation elements such as window trim, belt course, and variable roof forms, the unbalanced facade composition (overly heavy third story), disproportionate windows, non-harmonious roof forms produces an overly bulky building. (Guideline E-26 & 27)*

### UNDESIRABLE



*Using different colors on a building facade is not a successful way of providing vertical articulation as it does not create shadow or provide architectural relief. (Guideline E-26 & 27)*

## DESIRABLE



The building facade incorporates building projections, such as balconies, and recesses which enhance the design and articulation of the building. (Guideline E-27)

## DESIRABLE



The variable roof elements break the building masses into smaller units. (Guideline E-29)

- E-27 Incorporate projections and recesses throughout the façade design to add architectural interest and a visual play of light and shadow. Examples include: bay windows, chimneys, front porches, balconies, overhangs, brackets, and cornices.
- E-28 Incorporate building projections that enhance the design and articulation of the building. These may project into required front, side, and rear yards up to the limits allowed in the development standards.

## Roof Forms

- E-29 Incorporate variable roof forms into the building designs, to the extent necessary to avoid a boxy appearance of buildings. This may be accomplished by changes in roof height, offsets, change in direction of roof slope, dormers, parapets, etc.
- E-30 Design roof forms such that no more than two side-by-side units are covered by one unarticulated roof. Articulation may be accomplished by changing roof height, offsets, and direction of slope, and by introducing elements such as dormers, towers, or parapets. Other alternative design approaches that achieve the same goal of breaking down building masses into small individual units may also be acceptable, for example shifting the units in section and varying the design treatment for individual units.
- E-31 Design roof elements to have a functional integrity that is part of the overall building design. Do not use false roof forms, such as those used for purely decorative or advertising purposes. Do not use mansard roofs on any building with a height less than four stories.
- E-32 Call visual attention to corners and entries using architectural features such as tower elements.

## Windows

- E-33 Design window patterns and proportions to enhance all facades of the building and add architectural interest. Differentiate window designs (size, proportion) to reflect the different components of residential units, for example entrances, living areas, stairways, and bedrooms, while ensuring harmony within that variety.
- E-34 Design the locations and proportions of all window openings with consideration for the overall composition of the building facade.

## Rehabilitation and Remodeling

- E-35 Design remodels and additions to conserve the design integrity and character of the existing building.
- E-36 Do not close, move or enlarge exterior openings for doors and windows without consideration for the overall composition of the building, including all other remaining exterior openings.
- E-37 Design additions to existing buildings with consideration for the overall form of the resulting building or complex buildings; additions must not mix styles or introduce incongruous design motifs to an existing building or building complex.
- E-38 Do not remove or cover high quality original finish materials and ornamentation integral to the design integrity of the building with new incompatible materials.
- E-39 Use materials to fill openings or to repair damage to the existing building that match existing exterior materials.
- E-40 Design new windows and doors to match exist-

ing window, door and hardware materials, except when the existing materials are of low quality, in which case they all shall be replaced with wood or high-quality metal materials.

- E-41 Design elements added to the exterior of buildings, including windows and doors, security hardware, fire escapes, utility boxes, and screens of any kind, to be compatible with the existing design detail and composition of the building facade.
- E-42 Use exterior paint colors that conform to the Design Guidelines.

## UNDESIRABLE



*This project uses too many different window designs (different bay window styles, smaller windows are not consistent) which results in an inharmonious facade. (Guideline E-34)*

## DESIRABLE



*Although the windows on this facade differ in shape and size, the consistent use of trim style and windows with similarly space mullions help create a consistent look. (Guideline E-34)*

## DESIRABLE



*Sufficient distance between buildings on the same project site allows ground floor access to light and air. (Guideline F-2)*

## F. BUILDING SETBACKS FOR LIGHT, AIR, AND PRIVACY

The purpose of these guidelines is to ensure adequate setbacks for residential units in the project and ensure the project respects the residential units in adjoining buildings.

- F-1** Provide adequate light, air, and privacy for residential units in the project, as well as for residential units on adjoining properties.
- F-2** Provide distance between buildings on the same project site that is adequate to ensure light, air and privacy for adjacent residential units and to minimize shadows on open space.
- F-3** Use design strategies to protect privacy, such as: offsetting windows of adjacent units; locating minor windows above eye level, and using opaque glass for minor windows.

## G. AUTO CIRCULATION: SITE ACCESS AND DRIVEWAYS

These guidelines ensure a safe and convenient pedestrian environment and an attractive street frontage to accommodate pedestrian and bicycle activities.

### Site Access and Curb Cuts

- G-1 Minimize the number of entrances and exits to parking areas, in order to minimize conflicts with pedestrians, reduce congestion at street intersections, and preserve existing on-street parking.
- G-2 Locate entries and exits to allow direct, through movement among individual parking areas where possible.
- G-3 In the CVCBD, provide access to rear parking areas predominantly from side and rear streets; direct access from Castro Valley Boulevard and other major arterials is discouraged.

### Shared Site Access and Parking

- G-4 Minimize the number of entrances and exits to parking areas in order to minimize conflicts with pedestrians and reduce congestion at street intersections.
- G-5 Share parking areas and/or parking entrances/exits between adjacent properties to the maximum extent feasible. Place covenants on deeds to ensure continued shared use.
- G-6 Design vehicular circulation to allow through movement between adjacent parking areas.

### DESIRABLE



*In this project, commercial and residential parking is accessed using one driveway, which minimizes the number of entrances and exits to parking areas and reduces conflict with pedestrians. (Guideline G-1)*

### DESIRABLE



*The parking garage entrance is located on the side of the building and not along the main frontage street. (Guideline G-3)*

## DESIRABLE



The parking area is separated from the building by a landscaped area and walkway, which provides a better visual outlook for residents. (Guideline H-6)

## H. PARKING LOCATION AND DESIGN<sup>2</sup>

These guidelines ensure that the visibility of parking is minimized from public streets and that parking areas will not create a negative visual outlook for the residential units.

**H-1** Locate parking to the rear or side of buildings, underneath buildings, or underground and avoid land intensive surface parking lots. Recommended parking locations include the following:

- Interior Side Parking
- Rear Yard Parking
- Partial Below Grade Parking
- Below Grade Parking
- Tuck Under Parking
- Parking Wrapped with Living Space

**H-2** Disperse contiguously paved areas throughout the project in smaller segmented parking areas rather than creating land intensive surface parking lots.

**H-3** Do not locate parking between buildings and the street.

**A-1** 2. See Endnote

- Parking areas between the building edge and the sidewalk are not allowed. Buildings may be located behind other buildings that are located at the street edge, with on-site parking provided between the two sets of buildings.
- In the ACBD TA, locate all parking areas behind street frontage buildings and ground floor use areas.
- In ACBD RC, locate parking areas are to be interior to or at the back of the site where it is not visible to the street, and/or by garage space in the building where no more than one garage door is visible to the street. Apartment type buildings built over exposed parking spaces are not permitted.

**H-4** Locate garage entrances and driveways to the side of the property instead of at the center.

**H-5** Screen parking areas from view from the pedestrian sidewalk.

**H-6** Separate parking areas from buildings by at least a raised concrete walkway or a landscaped area, preferably both. Parking spaces must not directly abut buildings.



## I. FACILITIES FOR PEDESTRIANS, BICYCLES AND TRANSIT<sup>3</sup>

These guidelines ensure the provision of adequate facilities for pedestrians, bicycles and transit to promote and facilitate alternative modes of transportation and improve circulation in the Ashland Cherryland and Castro Valley Business Districts.

### Sidewalks, Street Trees, and Other Public Right-of-Way Improvements

- I-1 Provide new or repaired improvements in the public right-of-way along the lot frontage, including sidewalks, street trees, curbs, and gutters, following the Specific Plans and the Alameda County Engineering Design Guidelines.
- I-2 Provide street trees along the street frontage that enhance the visual appearance of the street and provide shade for pedestrians, but do not block the visibility of commercial signs.
  - In CVCBD, when a property located along Castro Valley Boulevard, Redwood Road, or Lake Chabot Road is not built out to the front property line, and where a landscape setback exists or is created, provide a second row of the designated street trees as part of the site landscaping.
  - In CVCBD, space trees planted adjacent to the sidewalk area to the established street tree pattern, creating a double row of street trees that provide an arcaded shade canopy for the sidewalk area.

A-1 3. See Endnote

### Pedestrian Sidewalks and Walkways

- I-3 Locate buildings to be contiguous wherever possible, and make accommodations for pedestrian circulation between adjacent businesses and sites.
- I-4 Where new parking areas are to be located adjacent to existing parking areas on an adjoining site or sites, provide pedestrian walkways that connect the two areas.
- I-5 Provide sidewalks within residential projects, connecting from the street or driveway to unit entrances.
- I-6 In CVCBD, provide pedestrian walkways with landscape amenities from within parking areas to permit and encourage direct access to Castro Valley Boulevard, Redwood Road, or Lake Chabot Road, to shop entries, and to other pedestrian-oriented uses and destinations.

### DESIRABLE



*Provide new or repaired improvements in the public right-of-way along the lot frontage, including sidewalks, street trees, curbs, and gutters. (Guideline I-1)*

### DESIRABLE



*In CVCBD, space trees planted adjacent to the sidewalk area to the established street tree pattern, creating a double row of street trees that provide an arcaded shade canopy for the sidewalk area. (Guideline I-2)*

## DESIRABLE



Provide short-term bike parking in parking areas and other locations near commercial building entrances. (Guideline I-9)

## DESIRABLE



Locate decorative paving in priority locations such as parking areas. (Guideline H-5)

## Decorative Paving

- I-7 Incorporate decorative pervious paving into paved and landscaped areas in order to enhance the appearance of the project, reduce the visual impact of paved surfaces and act as a traffic calming measure. Decorative paving includes: brick, patterned colored concrete (stamped, not just scored), stone blocks or pavers, interlocking colored pavers, grasscrete, and other comparable materials.
- I-8 Locate decorative paving in the following priority locations:
- The first 20 feet of the driveway closest to the street;
  - Parking areas;
  - Parking areas or fire turnarounds that can also occasionally function as outdoor courtyards.

## Bicycle Parking and Storage

- I-9 Provide short-term bike parking in parking areas and other locations near commercial building entrances.
- I-10 Provide accessible and secure on-site bicycle parking/storage facilities in each residential building per Climate Action Plan.

## Transit Shelters

- I-11 If the provision of a transit shelter is required, provide transit shelter that enhances the streetscape and that offers adequate seating and shade

## J. SITE LANDSCAPING<sup>4</sup>

These guidelines serve to ensure that projects provide landscaping to manage stormwater, support passive heating and cooling, improve air quality, provide an attractive visual outlook for residences, and beautify neighborhoods and communities. In addition, the following guidelines support the use of landscaping as an integral part of design to promote quality of life and the environment.

### Site Plan and Landscaping Treatments

- J-1 Incorporate landscaping in order to create an attractive visual outlook for residential units, create usable open space, maximize stormwater infiltration, and provide privacy for adjacent residential units. Provide at least the minimum percentage of site landscaping required.
- J-2 Design site landscape treatments to be attractive, with a consistent design integrity throughout the project.
- J-3 Front and street-side yard landscaping shall be primarily of living plant material. Rock material other inorganic materials shall be minimized.

---

4. See Endnote

#### DESIRABLE



*Provide landscaping within common open space areas. (Guideline J-3)*

#### DESIRABLE



*Incorporate landscaping in order to create an attractive visual outlook for residential units. (Guideline J-1)*

#### DESIRABLE



*Provide landscaping along the property perimeter. (Guideline J-3)*

## DESIRABLE



*Incorporate trees, landscape islands, shrubs, and groundcover throughout parking areas. (Guideline J-7)*

## DESIRABLE



*Shade paved surfaces to the maximum extent feasible to reduce heat gain and other environmental effects. (Guideline J-8)*

## Site Landscaping Locations

- J-4 Provide site landscaping in the following priority areas:
- Between commercial and residential buildings
  - In areas that are visible from the primary living areas of residential units
  - Within common open space areas
  - Along the edge of driveways
  - Along the property perimeter
  - Between buildings and driveways
  - Between buildings and parking
- J-5 Do not reduce the amount of existing landscaping on site.

## Parking Area Landscaping

- J-6 Landscape parking lots, driveways, and other auto circulation areas in order to improve the visual appearance of circulation and parking areas from residential units, from the common areas of the project, and from adjacent properties.
- J-7 Incorporate trees, landscape islands, shrubs, and groundcover throughout parking areas, consistent with required standards.
- J-8 Shade paved surfaces to the maximum extent feasible in order to reduce heat gain and other environmental effects.

## Stormwater Management

- J-9 Incorporate best management practices for stormwater management, per Alameda County requirements under the Clean Water Act permit (Municipal Regional Stormwater Permit of October 14, 2009) and per the Alameda County Engineering Design Guidelines.

## DESIRABLE



*Incorporate innovative stormwater management practices, such as permeable pavers in parking areas. (Guideline J-11)*

## DESIRABLE



*Design any landscaped areas serving as stormwater management areas to be visually appealing / aesthetic. (Guideline J-10)*

**J-10** Design any landscaped areas serving as stormwater management areas to be visually appealing / aesthetic.

**J-11** Integrate stormwater management facilities into the site landscaping. Innovative stormwater management practices are encouraged. Use of mechanical management systems are generally not allowed.

### Site Landscaping Materials

**J-12** Provide landscaping to comply with the State's Water Efficient Landscape Ordinance (AB-1881), as amended, or as incorporated into Alameda County WELO Ordinance.

**J-13** Select landscaping materials that meet the following criteria:

- Hardy enough to withstand close contact with pedestrians and vehicles.
- Non-invasive plants that are not listed by the Invasive Species Council of California (ISCC) in the "Invasive Species List and Scorecard of California", as amended.

**J-14** Landscape areas requiring higher water usage for maintenance are encouraged to be located in small courtyards and other kinds of intensively used areas.

**J-15** Use fast growing, long lived species that will achieve the desired size and form at maturity without extensive pruning or training once they have been established.

**J-16** Use accent landscaping and special landscape elements, such as feature planting, including free-standing columns or trellises with vines for vertical accent, to give visual expression to site circulation, especially at entrances and exits.

### DESIRABLE



Select landscape materials that are bay-friendly, drought-tolerant, and low water use. (Guideline J-12)

### DESIRABLE



Select landscape materials that are hardy enough to withstand close contact with pedestrians and vehicles and that cover bare dirt once fully grown. (Guideline J-13)

## DESIRABLE



*In this example, the tot lot is located in a central location and accessible by the residential units and includes seating for adults supervising their children. (Guideline K-3 and K-4)*

## UNDESIRABLE



*In this example, the tot lot is located far away from residential units. (Guideline K-3)*

## DESIRABLE



*This project provides seating areas and tables in the common open space area. (Guideline K-1)*

## K. USABLE OPEN SPACE<sup>5</sup>

These guidelines ensure that projects provide enjoyable usable outdoor living areas for residents and light access, privacy, and a sense of openness is maintained in higher density developments.

### Usable Open Space for Residents

**K-1** Provide both common open space and private open space for residents' recreation and relaxation.

- Design common open space as a space where people can interact, host guests, and also enjoy some time alone in the fresh air.
- Design private open space for the exclusive use household members to eat outside, garden, enjoy the fresh air, and grill outdoors.

**K-2** Provide usable open space that may have a dual function for stormwater treatment and incorporates strategies such as grassy swales, vegetated swales, flow through planters, rain gardens, etc.

### Common Open Space: Courtyards, Plazas, and Green Spaces

**K-3** Design common open space(s) to be a shared open space for use by all residents.

**K-4** Locate common open space(s) in a central location that serves all the units, not at an extreme edge of the property. Common open space can be on the ground, or in courtyards above the ground level.

**K-5** Include seating areas and other passive recreation facilities.

---

5. See Endnote

- K-6 Include landscaping with trees, shrubs, and groundcover. If the space is not located on the ground, include extensive pots and planter boxes that accommodate trees, shrubs, and groundcover. See Site Landscaping Materials section for appropriate materials.
- K-7 Include children's play areas in one of the common open spaces, unless the size and layout of the units are targeted exclusively towards empty-nesters, singles, and seniors.

**Private Open Space: Yards, Patios, and Balconies**

- K-8 Design private open space to be used exclusively by a single unit.
- K-9 Locate private open space in patios, balconies, decks, or other outdoor spaces attached to individual units.
- K-10 Dimension private open space so there is room for a table and chairs where residents can sit outside.

**DESIRABLE**



*This project incorporates chairs and landscaping in the common open space area, giving residents a space where people can interact, host guests, and also enjoy some time alone in the fresh air. (Guideline K-1)*

**DESIRABLE**



*This balcony is dimensioned where there is room for a table and chairs where residents can sit outside. (Guideline K-9)*

## DESIRABLE



*Design fences and walls to be an attractive part of the project, with materials and designs that are compatible with the exterior building materials and demonstrate integrated design integrity in the project as a whole. (Guideline L-1)*

## DESIRABLE



*Locate fences or walls on the property to define private open space and common open space areas, protect privacy, and buffer residents from noise sources. (Guideline L-2)*

## L. FENCES AND WALLS

These guidelines ensure that fences and walls contribute to an attractive street appearance.

- L-1 Design fences and walls to be an attractive part of the project, with materials and designs that are compatible with the exterior building materials and demonstrate integrated design integrity in the project as a whole.
- L-2 Locate fences or walls on the property to define private open space and common open space areas, protect privacy, and buffer residents from noise sources
- L-3 Use masonry materials for sound reduction purposes.
- L-4 Build fences and walls using masonry materials, and include a top or cap. Wood fences are acceptable in situations where it is not separating commercial and residential uses, and it is not likely to be damaged by automobile or truck traffic.
- L-5 Chain link or chain link with slats is not permitted.



## M. SERVICES

Service area guidelines ensure that these areas do not detract from the overall quality of the common areas within projects. Additionally, they ensure that pedestrian connections are not disrupted by service or loading areas..

### General

**M-1** Locate ancillary facilities within buildings, not along the street facing facade, to the maximum extent feasible. Where ancillary facilities such as trash receptacles and utility meters absolutely cannot be incorporated into a building, locate them at the rear of the site in freestanding, completely enclosed structures designed to be compatible with the architecture of the rest of the development. (Guideline M-1)

### Loading

**M-2** Design streets and driveways to accommodate vehicles commonly used for loading and unloading.

**M-3** Minimize the visibility of loading areas in mixed-use residential complexes, and screen them with screen walls, landscaping, and other devices.

### Trash

**M-4** Provide on-site facilities for trash storage and for recyclable materials.

**M-5** Provide trash areas within buildings, or centralized garbage dumpsters inside trash enclosures.

**M-6** Build covered trash enclosures with durable materials such as stone, concrete block, steel, and heavy timber.

### Utilities

**M-7** Locate electrical panels to minimize their visibility from the street, in locations such as side yard walls, and/or behind landscaped areas. Integrate them into the design of residential buildings to the maximum extent feasible.

**M-8** Minimize the visibility of utilities connections from the public street.

### Storage

**M-9** Provide bulk storage areas in garages or in residential buildings so people do not store bulk goods on outdoor balconies or patios that are visible to other residents.

### DESIRABLE



Where ancillary facilities, such as trash receptacles, absolutely cannot be incorporated into a building, locate them in freestanding, completely enclosed structures designed to be compatible with the architecture of the rest of the development. (Guideline M-1)

### DESIRABLE



Locate electrical panels to minimize their visibility from the street. In this example, utility meters are located on the interior side wall instead of the street-facing facade. (Guideline M-7)

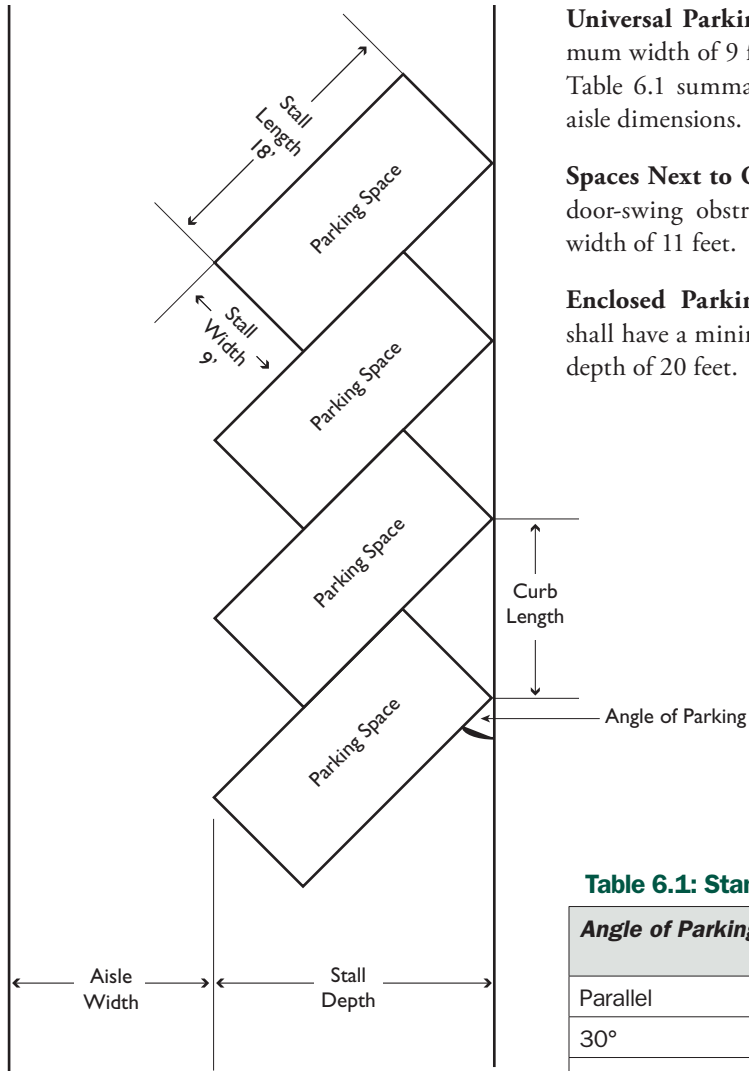
## ENDNOTE

When meeting the design guideline or the design guidelines within this topic, the project must exhibit an overarching intent to reduce water quality impacts of development. Site Design Measures in combination with Low Impact Development must be integrated into development projects wherever feasible and practicable.

# 6

## **STANDARDS THAT APPLY TO ALL OR SOME DEVELOPMENT PROJECTS WITH RESIDENTIAL USES**

**Figure 6-1: Parking**



**PARKING**

**Universal Parking Space.** Spaces must have a minimum width of 9 feet and a minimum depth of 18 feet. Table 6.1 summarizes the standard parking space and aisle dimensions.

**Spaces Next to Obstructions.** Parking spaces next to door-swing obstruction must have a minimum stall width of 11 feet.

**Enclosed Parking Space.** Enclosed parking spaces shall have a minimum width of 9 feet and a minimum depth of 20 feet.

**Compact Parking Space.** Compact spaces shall provide a minimum length of 16 feet and a minimum width of 8 feet.

**Residential Tandem Space.** When two or more parking spaces are reserved or required for a single dwelling unit, such spaces may be developed as tandem parking spaces, subject to any limitations in the development standards regarding the percentage of units with tandem spaces. Tandem parking spaces must have a minimum width of 9 feet and a minimum depth of 36 feet to accommodate two vehicles.

**Table 6.1: Standard Parking Space and Aisle Dimensions**

Angle of Parking	Stall Width	Curb Length Per Stall	Stall Depth	Aisle Width
Parallel	9'	22'	9'0"	15'
30°	9'	18'	17'	15'
45°	9'	12'8"	19'	15'
60°	9'	10'5"	20'	22'
90°	9'	9'	18'	25'

## BICYCLE PARKING

**Dimensions.** Each bicycle parking space shall be a minimum of 2 feet in width and 6 feet in length and shall be accessible without moving another bicycle.

### Required Short Term Bicycle Parking

**Commercial/Office Uses.** Short-term bicycle parking spaces shall be provided at a rate of two percent of the number of required automobile parking spaces, with a minimum of two parking spaces provided per establishment.

**Residential Uses.** There shall be a minimum of one bicycle parking space per 25 units.

**Location.** Short-term bicycle parking shall be located within 50 feet of the primary building entrance. Bicycle parking shall be located on private property, unless the Public Works Director approves an encroachment permit for bicycle parking within the public right-of-way. A minimum four foot clear width for pedestrian circulation and handicapped access in public sidewalks shall be maintained.

Bicycle parking shall be visible from the street or from the main building entrance.

### Required Long Term Bicycle Parking

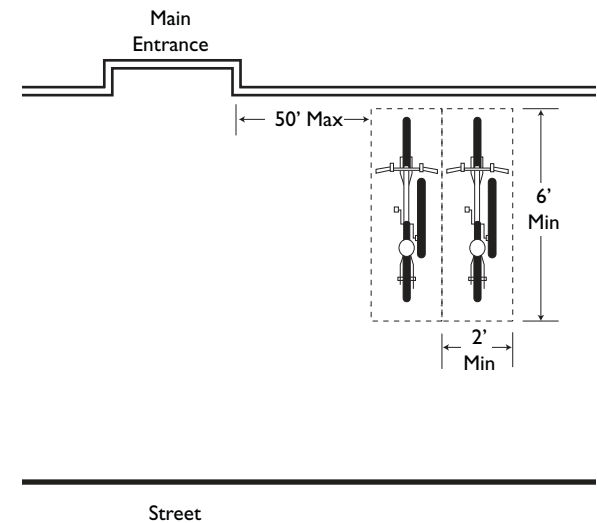
**Commercial/Office Uses.** Any establishment with 25 or more employees shall provide long-term bicycle parking at a ratio of one space per 25 vehicle spaces.

**Multi-Family Residential Uses.** For multi-family residential development, a minimum of one bicycle parking space shall be provided for every four units.

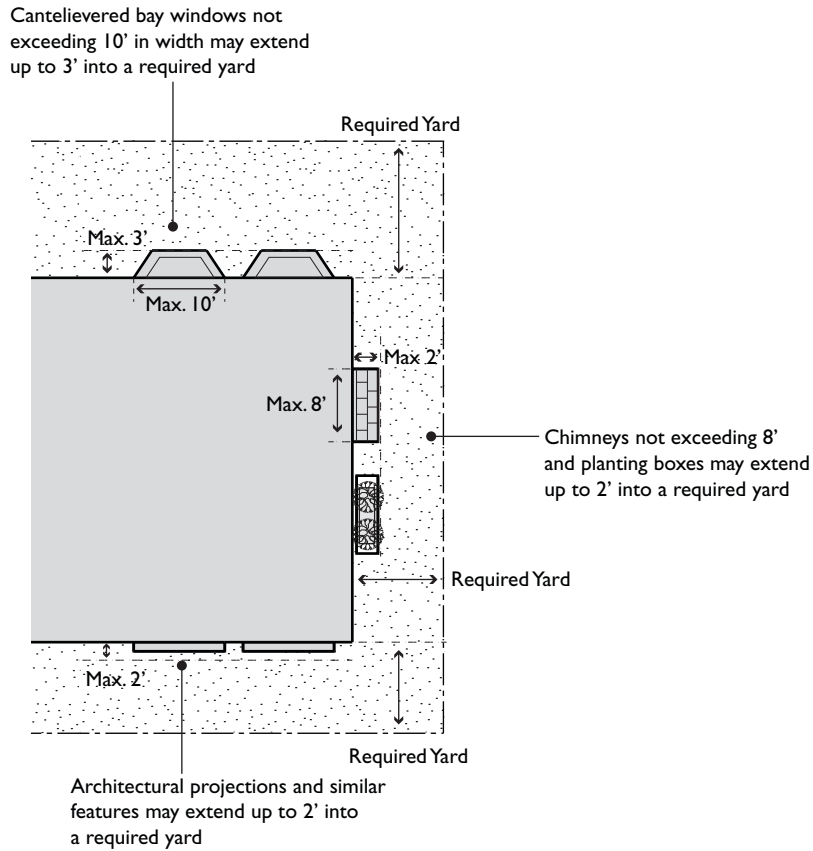
**Location.** Long-term bicycle parking must be located on the same site as the use it serves, and shall be in an enclosed bicycle locker, or a fenced, covered, and locked bicycle storage area. Bicycle storage on open balconies is not permitted, unless there is a large enclosed storage area and bicycles are not publicly visible.

**Employee Showers and Lockers.** Employee showers and lockers shall be provided in all non-residential buildings as per the Climate Action Plan.

Figure 6-2: Bicycle Parking



**Figure 6-3: Projections**



## PROJECTIONS INTO REQUIRED YARDS

Cornices, canopies, eaves, sills, buttresses or similar architectural features, chimneys and fireplaces not exceeding eight feet in width, and planting boxes may project a maximum distance of two feet into any required yard.

Cantilevered bay windows, covered landing place, and/or covered porch not exceeding cumulative width of 10 feet and leading to a dwelling unit entrance not greater than six feet above the ground level, and the stairway leading thereto, may project into a required yard a distance not greater than three feet.

## FENCES AND WALLS

**Maximum Height.** Fences and walls may be erected and maintained in required yards subject to the requirements specified herein:

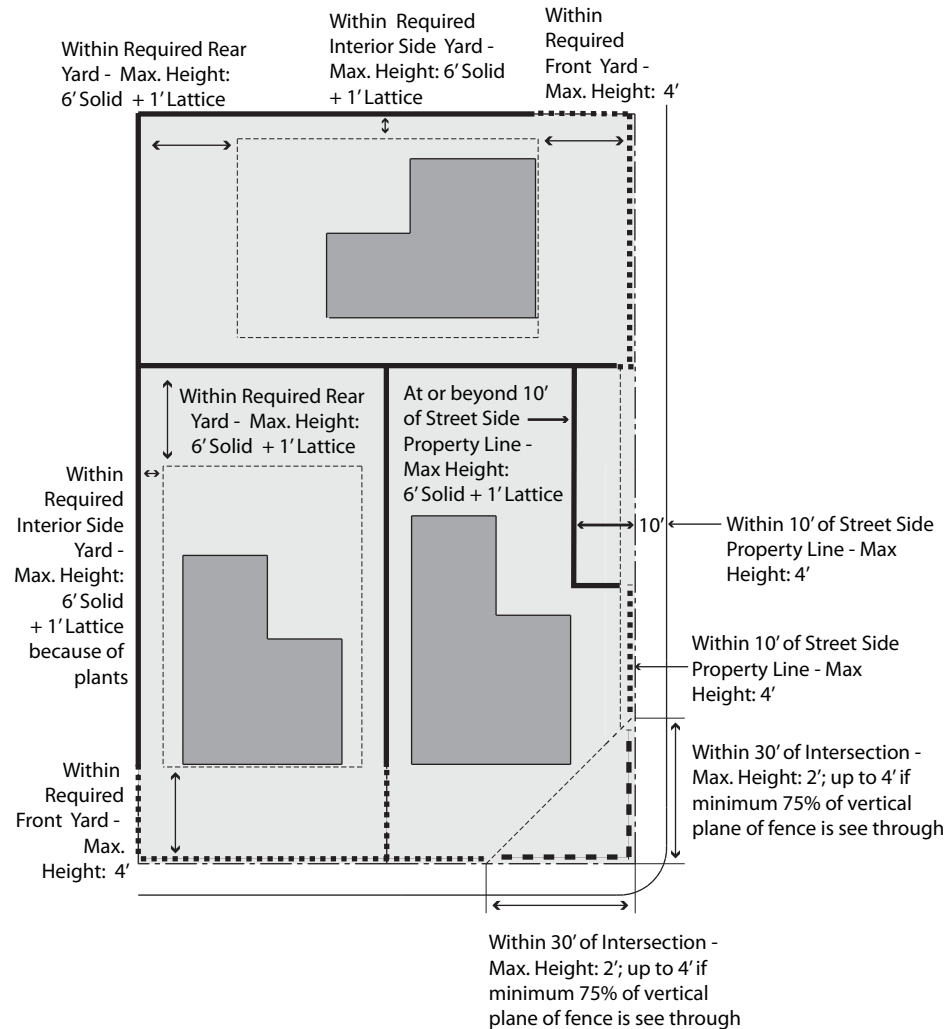
**Within 30' of Intersection.** Fences within 30 feet of an intersection shall not exceed two feet in height. Fences may be built to a height of four feet, provided that at least 75% of the vertical plane of the fence is see through.

**Front Yards.** Fences within the required front yard shall not exceed four feet in height. Front yard entrance structures such as trellises shall not exceed seven feet in height. The width of front yard entrance structures cannot exceed 15% of the lot street frontage and must include an opening for entry. Fences and entrance structures within the required front yard shall be at least 50% see-through, unless visibility is blocked because of plants.

**Street Side Yard.** Fences within ten feet of the street side yard property line shall not exceed four feet in height. Fences at or beyond ten feet of the street side property line shall not exceed 6 feet in height. Fences at or beyond ten feet of the street side property line may be built to a height of seven feet, provided that the portion of the fence exceeding six feet in height consists of lattice or similar non-solid material.

**Interior Side Yard.** Fences within the required interior side yard shall not exceed 6 feet in height. Fences may be built to a height of seven feet, provided that the portion of the fence exceeding six feet in height consists of lattice or similar non-solid material.

Figure 6-4: Fences



**Rear Yard.** Fences within the required rear yard shall not exceed 6 feet in height. Fences may be built to a height of seven feet, provided that the portion of the fence exceeding six feet in height consists of lattice or similar non-solid material.

**Outside of Required Yards.** Fences outside of required yards shall not exceed 6 feet in height. Fences may be built to a height of 7 feet, provided that the portion of the fence exceeding 6 feet in height consists of lattice or similar non-solid materials.

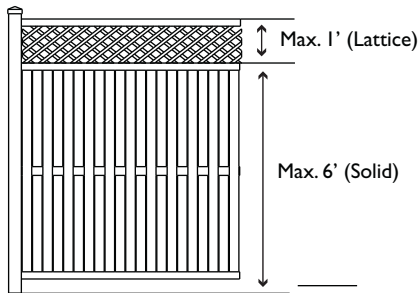
### ACBD Mixed-Use Projects

If a fence is provided between the residential front lawn setback and the required landscape setback for the adjacent commercial frontage, the maximum height shall be 4 feet.

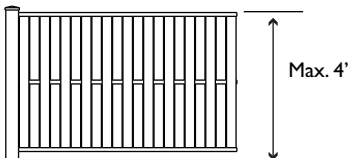
Commercial development and/or all paved areas adjacent to residential development shall be separated by a masonry wall built to a minimum height of 6 feet and a maximum height of 8 feet.

**Figure 6-5: Fence Heights**

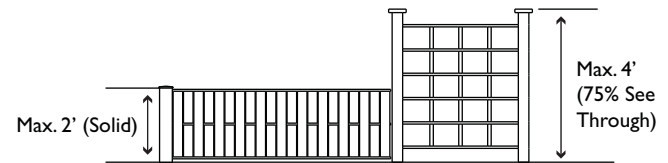
Fences within Required Rear Yard, Interior Side Yard, and at or Beyond 3' of Street Side Property Line



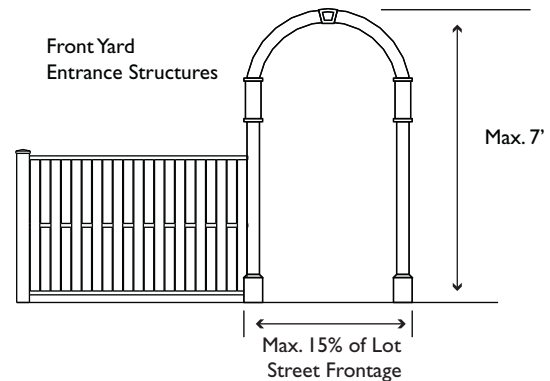
Fences within Required Front Yard, and within 3' of Street Side Property Line



Fences within 30' of Intersection



Front Yard Entrance Structures





## TRASH ENCLOSURES

Multi-family residential (“flats”) projects that include more than 10 units shall provide a centralized garbage dumpster and a trash enclosure in accordance with the following standards:

### Location

The solid waste and recycling storage area shall not be located within any required front yard, street side yard, any required parking, landscaped and open space areas.

Solid waste and recycling areas shall be consolidated to minimize the number of collection sites and located so as to reasonably equalize the distance from the building spaces they serve.

Solid waste and recycling storage areas shall be accessible to haulers.

### Materials, Construction, and Design

**Minimum Height of Screening.** Solid waste and recycling storage areas located outside or on the exterior of any building shall be screened with a six foot high solid enclosure.

**Enclosure Material.** Enclosure material shall be solid masonry or concrete tilt-up with decorated exterior-surface finish compatible to the main structure(s).

**Gate Material.** Gate material shall be decorative, solid, heavy-gauge metal or a heavy-gauge metal frame with a covering of a view-obscuring material. If not visible from a public street, public parking area, or residential area, the enclosure gates may be constructed of chain link with wood or plastic inserts.

**Access to Enclosure from Residential Projects.** Each solid waste and recycling enclosure serving a residential project shall be designed to allow walk-in access without having to open the main enclosure gate.

**Enclosure Pad.** Pads shall be a minimum of four-inch-thick concrete.

**Protection for Enclosures.** Concrete curbs or equivalent shall protect enclosures from adjacent vehicle parking and travel ways.

**Landscaping.** The perimeter of the recycling and trash enclosure shall be planted with drought resistant landscaping, including a combination of shrubs and/or climbing evergreen vines.

**Clear Zone.** The area in front of and surrounding all enclosure types shall be kept clear of obstructions.

## PARKING LOT AREA LANDSCAPING

A minimum of 10 percent of any parking lot area shall be landscaped. For the purpose of calculating required parking lot landscaping, parking lot areas are deemed to include parking and loading spaces as well as aisles, vehicle entry and exit areas, and any adjacent paved areas. Parking lot area does not include enclosed vehicle storage areas.

**Minimum Planter Dimension.** No landscape planter that is to be counted toward the required landscape area shall be smaller than 25 square feet in area, or four feet in any horizontal dimension, excluding curbing.

**Layout.** Landscaped areas shall be well-distributed throughout the parking lot area. Parking lot landscap-

ing may be provided in any combination of:

- Landscaped planting strips at least four feet wide between rows of parking stalls;
- Landscaped planting strips between parking areas and adjacent buildings or internal pedestrian walkways;
- Landscaped islands located between parking stalls or at the ends of rows of parking stalls; and
- On-site landscaping at the parking lot perimeter.

**Required Landscaped Islands.** A landscaped island at least six feet in all interior dimensions and containing at least one 15-gallon-size tree shall be provided at each end of each interior row of parking stalls and between all consecutive parking stalls in the following ratios:

- Between every six consecutive stalls in a residential development or in a mixed-use development in which residential units overlook onsite parking areas.

**Landscaped Buffer for Open Parking Adjacent to Right-of-Way.** A landscaped buffer area shall be provided between any surface parking area and any property line adjacent to a public street. The landscaped buffer shall have a minimum width as listed below unless a different dimension is specified in the base district standards applicable to a site.

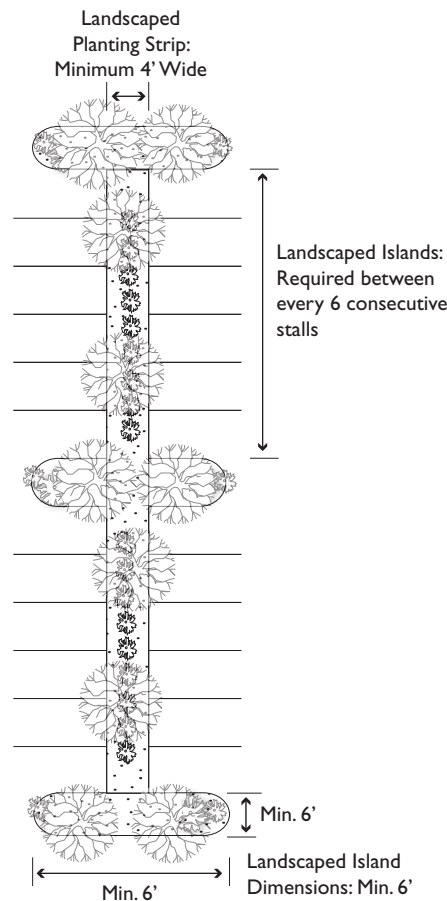
- Five feet for any property with less than 100 feet of frontage.
- Ten feet for any property with 100 feet of frontage or more.

**Landscaped Buffer for Open Parking Abutting Interior Lot Line.** A landscaped area at least five feet wide shall be provided between any surface parking area and any adjacent lot for the length of the parking area.

**Trees.** Trees shall be planted to result in 50 percent shading of parking lot surface areas within 15 years.

- **Distribution.** Trees shall be distributed relatively evenly throughout the parking area.
- **Species.** Required trees for parking lots shall be selected from a list of recommended trees maintained by the Community Development Department.
- **Minimum Planter Size.** Any planting area for a tree must have a minimum interior dimension of five feet. Additional space may be required for some tree species.

**Figure 6-6: Landscaped Islands**



**Additional Requirements – ACBD**

**Trees.** Surface parking areas shall include trees that are planted to shade parking spaces. These trees shall be no farther apart than the width of 4 parking spaces. Tree species shall be selected that provide maximum shade cover and that can be pruned to a minimum ground to lower branch height of 8 feet.

**Landscaped Buffer.** Landscape setbacks along parking area frontage shall include some form of low wall at a height convenient for sitting, easily accessible from the street and designed to allow pedestrian access to the parking area at points no farther apart than 10 feet. Planting shall include trees and the width shall be 6-10 feet, dependent upon the effectiveness of the landscaping and wall in providing the sidewalk and parking area.

**Additional Requirements –CVCBD**

**Trees.** In parking lots, trees shall be planted at a ratio of one to every three or four linear spaces, or approximately thirty-five feet, on-center.

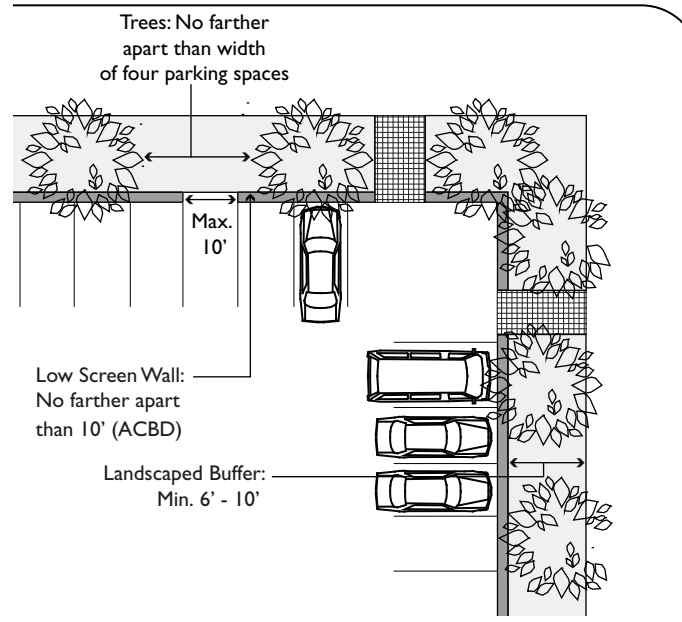
**Landscaped Buffer.** Where surface parking areas exist adjacent to a public street, a minimum ten foot wide planting area shall be provided between the edge of paving and the public sidewalk. The landscape treatment of this planting area is to provide a transition from the surface parking to the streetscape improvements and, through use of one or a combination of elements, consisting of low shrubs, textured walls, ground cover and/or trees.

Existing or proposed setback areas, including the edge between the sidewalk and the parking street are to receive special landscape design treatment that is compatible with and complementary to adjacent streetscape improvements.

**Planters.** The minimum width of planters for screening is six feet; the minimum width of planters for accent is five feet.

**Ground Cover.** Ground cover planting is to be spaced to achieve full coverage within two to three years. Organic materials such as tan bark shall be used to cover bared dirt. Exception for bio-retention landscaping areas that are meant as stormwater treatment solutions to meet the requirements of the Municipal Regional Permit (MRP).

**Figure 6-7: Additional Specific Plan Requirements**



*Page Intentionally Left Blank*

# 7

# DEFINITIONS AND RULES OF MEASUREMENT

## DEFINITIONS

**Abutting or Adjoining.** Having a common boundary, except that parcels having no common boundary other than a common corner shall not be considered abutting.

**Adjacent.** Directly abutting, having a boundary or property line(s) in common or bordering directly, or contiguous to.

**Bay-friendly Landscaping.** Bay-friendly landscaping is a whole systems approach to the design, construction and maintenance of the landscape in order to support the integrity of one of California’s most magnificent ecosystems, the San Francisco Bay watershed. Bay-friendly landscapes act in harmony with the natural conditions of the San Francisco Bay watershed, reduce waste and recycling materials, nurture healthy soils while reducing fertilizer use, conserve water, energy and topsoil, use integrated pest management to minimize chemical use, reduce stormwater runoff and air pollution, and protect and enhance wildlife habitat and diversity.

**Building Footprint.** The horizontal area, as seen in plan view, of a building or structure, measured from the outside of exterior walls and supporting columns, and excluding eaves. See also “Determining Lot Coverage.”

**Building Height.** The vertical distance from any and all points on the ground below a structure to corresponding points vertically above. See also “Measuring Height.”

**Building Site.** *“Building site” means the land area, consisting of one or more recorded lots which consti-*

*tute a unit, either under one ownership or for use as a condominium, which is to be considered as a site either occupied or to be occupied by a main building or buildings and accessory buildings or by a principal use and accessory uses together with the effective lot frontage on a street, and the yards, open spaces and parking and loading spaces required by these regulations.*

**Compatible.** That which is harmonious with and will not adversely affect surrounding buildings and/or uses.

**Facade.** The exterior wall of a building exposed to public view or that wall viewed by persons not within the building. The portion of any exterior elevation of a building extending vertically from the grade to the top of a parapet wall or eave, and horizontally across the entire width of the building elevation.

**Floor Area.** The total gross horizontal area of all the floors below the roof and within the outer surface of the walls of a building or structure, including basements, mezzanines, interior balconies, and upper stories or levels in a multistory building unless otherwise stipulated.

**Footprint.** The horizontal area, as seen in plan view, of a building or structure, measured from the outside of exterior walls and supporting columns, and excluding eaves. See also “Determining Lot Coverage.”

**Frontage, Public Street.** That portion of a lot or parcel of land that borders a public street. “Street frontage” shall be measured along the common lot line separating said lot or parcel of land from the public street, highway, or parkway.

**Grade.** The location of the ground surface.

- Existing Grade. The elevation of the ground at any point on a lot as shown on the required survey submitted in conjunction with an application for a building permit or grading permit.
- Finished Grade. The lowest point of elevation of the finished surface of the ground, paving, or sidewalk within the area between the building and the property line, or when the property line is more than five feet from the building, between the building and a line five feet from the building.

**Hillside.** Building sites with an average slope exceeding 10 percent gradient. (Fairview Specific Plan.) See also “Determining Average Slope.”

**Lot Coverage.** The portion of a lot that is covered by structures, including principal and accessory buildings, garages, carports, and roofed porches, but not including unenclosed and unroofed decks, landings, or balconies. See also “Determining Lot Coverage.”

**Low Impact Development (LID).** One of LID’s primary goals is to reduce runoff volume by infiltrating rainfall water to groundwater, evaporating rainwater back to the atmosphere after a storm and finding beneficial uses for water rather than exporting it as a waste product down storm sewers. The result is a landscape functionally equivalent to predevelopment hydrologic conditions, which means less surface runoff and less pollution damage to lakes, streams, bay and coastal waters. LID employs principles such as preserving and recreating natural landscape features and minimizing imperviousness to create functional and appealing site drainage that treats stormwater as a resource, rather than a waste product. Practices used to adhere to these

LID principles include measures such as rain barrels and cisterns, green roofs, permeable pavement, preserving undeveloped open space, and biotreatment through rain gardens, bioretention units, bioswales, and planter/tree boxes.

### Open Space Types.

**Total Usable Open Space.** Total usable open space is the combination of common usable open space and private usable open space.

**Common Usable Open Space.** Common usable open space is open space for use by all residents, which meets the minimum dimensions established by the development standards of the zoning district. Common usable open space may be on the ground, or in courtyards above parking.

**Private Usable Open Space.** Private usable open space is open space that is used exclusively by a single unit. Private usable open space may be on the ground, or in balconies and decks.

**Prevailing.** Over half of the five parcels on either side of the subject parcel, plus the parcels across the street.

*Riparian Area. Any area for which a watercourse, intermittent or perennial; pond; lake; marsh; or any other wetland; or the vegetation of wildlife dependent on or associated with any of the above, forms the environmental focal point. The limits of a riparian area will normally be considered the demarcation line between the vegetation zones of wetland and upland.*

**Site Design Measures.** Measures that reduce water quality impacts, will minimize impervious surfaces and direct stormwater runoff from impervious surfaces to vegetated areas. Examples include, stormwater detention, retention, and infiltration of runoff, like concave medians, grass/vegetated swales, green roofs, rain gardens, flow-through planters, stormwater curb extensions, permeable pavements, and conservation of natural areas.

**Site Landscaping.** Site landscaping includes landscaped areas that are not paved or covered with buildings. Site Landscaping includes planted areas and all usable open space areas (which may include some paved walkway or recreation areas.) All building footprint areas and areas paved for auto access are excluded, except for grasscrete or comparable materials that allow plants to grow through paving blocks.

*Story. That portion of a building included between the upper surface of any floor and the upper surface of the floor next above except that the topmost story shall be that portion of a building included between the upper surface of the topmost floor and the ceiling or roof above. If the finished floor level directly above a basement, cellar, or unused underfloor space is more than six feet above grade as defined herein, or more than fifty (50) percent of the total perimeter, or is more than twelve (12) feet above grade as defined herein at any point, such basement, cellar, or unused underfloor space shall be considered a story.*

## RULES OF MEASUREMENT

### Determining Developable Site Area

Developable Site Area includes:

1. Areas of less than 30% slope;
2. Areas outside of any private streets, street parking spaces, access, easements, stems, driveways that serve more than one lot, and any other unservable or unbuildable portion of the lot; and
3. Areas outside of riparian areas (See Riparian Areas).

### Determining Area per Dwelling Unit

The area per dwelling unit of a project is calculated using the following formula:

Area = Developable Site Area/Number of Dwelling Units

### Measuring Height

**Measuring Building Height.** Building height is measured vertically from the structure perimeter at existing or finished grade, whichever is lower. The allowed structure height shall be at or below that imaginary plane located vertically above the points measured from the structure perimeter at existing or finished grade, whichever is lower. Hillside Areas as provided in Table 2.2-2.

**Measuring Height of Fences on Retaining Walls.** The height of fences on retaining walls shall be measured from the midpoint of the retaining wall to the top of

the fence.

### Determining Average Slope

The average slope of a parcel is calculated using the following formula:  $S = 100(I)(L)/A$ , where:

S = Average slope (in percent)

I = Contour interval (in feet)

L = Total length of all contour lines on the parcel (in feet)

A = Area of subject parcel (in square feet)

### Determining Lot Coverage

*In calculating the percentage of lot coverage, the area at ground level of all roofed buildings on the premises shall be included as coverage, excluding*

- Cornices, canopies, eaves, sills, buttresses or similar architectural features, chimneys and fireplaces not exceeding eight feet in width, and planting boxes that project a maximum distance of two feet into any required yard; and
- Cantilevered bay windows not exceeding 10 feet in width, or a landing place, porch, and stairway leading to a dwelling unit entrance not greater

than six feet above the ground level.

### Determining Lot Frontage

- Lots with Public Street Frontage. The front of a lot is that which abuts the public street.
- Lots without Public Street Frontage. If a lot does not abut a public street, the front of a lot is that which abuts the access driveway or private street.

– Exceptions:

**Single-Family Subdivisions.** If a project site is less than 100 feet in width, the front of the lot is that which faces the public street.

**Small-Lot Single Family Homes.** If a project site is less than 80 feet in width, the front of the lot is that which faces the public street.

### Determining Setbacks

The following special regulations for determining setbacks apply when a lot, with no public street frontage, abuts a sidewalk on a private street.

**Garages.** For garages, the required setback shall be measured from the back of the sidewalk.

**Living Space.** For living space, the required setback shall be measured from the edge of vehicle lane.



## POLICIES

### Stormwater Policy:

#### Design Requirements for Post-Construction Measures

All projects shall incorporate appropriate site design measures and low impact development principles to minimize impacts to water quality. These may include, but are not limited to, the following: (a) minimizing impervious surfaces, especially directly connected impervious surfaces, (b) clustering buildings, (c) preservation of quality open space, (d) maintaining and/or restoring riparian areas and wetlands and establishing vegetated buffer areas to minimize pollutants in stormwater runoff or minimize peak runoff.

All applicable projects shall be required under the Alameda County Cleanwater Program to incorporate appropriate site design measures to minimize impacts to water quality. These may include, but are not limited to, the following:

1. Minimize land disturbance;
2. Minimize impervious surfaces (e.g., roadway width, driveway area, and parking lot area), especially directly connected impervious areas;
3. Minimum-impact street design standards for new development and redevelopment, including typical specifications (e.g., neo-traditional street design standards and/or street standards recently revised in other cities, including Portland, Oregon, and Vancouver, British Columbia);
4. Minimum-impact parking lot design standards, including parking space maximization within a given area, use of landscaping as a stormwater drainage fea-

ture, use of pervious pavements, and parking maxima;

5. Clustering of structures and pavement;
6. Typical specifications or acceptable design guidelines for lot-level design measures, including:
  - Disconnected roof downspouts to splash blocks or .bubble-ups;
  - Alternate driveway standards (e.g., wheel-ways, unit pavers, or other pervious pavements); and,
  - Micro-detention, including landscape detention and use of cisterns (may also be considered treatment measures);
  - Preservation of high-quality open space;
7. Maintenance and/or restoration of riparian areas and wetlands as project amenities, including establishing vegetated buffer zones to reduce runoff into waterways, allow for stream channel change as a streams contributing watershed urbanizes, and otherwise mitigate the effects of urban runoff on waters and beneficial uses of waters (may also be considered treatment measures); and,
8. Incorporation of supplemental controls to minimize changes in the volume, flow rate, timing, and duration of runoff, for a given precipitation event or events. These changes include cumulative hydromodification caused by site development. Measures may include landscape-based measures or other features to reduce the velocity of, detain, and/or infiltrate stormwater runoff (may also be considered treatment measures).

### Policy Statement for Lot Size Consistency of Single Family Subdivision in Castro Valley

(The Policy Statement is currently up for review as part of the Castro Valley new General Plan, expected in 2010)

New single-family parcels must be consistent with the existing land use pattern of the surrounding neighborhood. Even though subdivision proposals may meet the minimum zoning requirement for lot size or median width, they may not create lots substantially smaller or narrower than the prevailing lots in the neighborhood.

**Background:** The purpose of this policy statement is to clarify, enhance, and reaffirm the existing General Plan policies listed below. This policy statement applies community-wide to neighborhoods with R-1 (Single Family Residential) zoning with any attached combining district (e.g. R-1-B-10), and also any area zoned PD based on a R-1 District, where proposed subdivision would be incompatible with established single family development patterns.

The Castro Valley Plan (1985) includes the following principles regarding suburban and low density residential land-uses:

**Page 57** Within predominantly single-family residential areas, the density of new suburban and low density residential development should be approximately the same as that of surrounding residential uses.

**Page 58** Suburban and low density residential projects may include attached and/or detached residential units, provided that the development is other wise compatible, in scale, bulk, and siting with surrounding residential uses....

Most of the new residential development in Castro Valley has been provided through infill development. Infill allows more intensive land uses in existing urbanized and suburbanized areas where public services such as water, sewer, and fire protection are readily available. However, in certain cases, infill development can result in changes overall aesthetic appearance of a neighborhood through on-street parking, alteration of natural topography, and removal of mature vegetation. Other factors, such as increased traffic, the placement of easements and demands to public utilities can also change neighborhood character as a result of infill. This policy statement gives guidance to decision makers while deciding when and where infill development should take place. It is not intended to preclude infill development which meets County policies.

Infill development in Castro Valley is primarily regulated by the County General Plan, the Zoning Ordinance, and the Subdivision Ordinance. It should be noted that the Zoning Ordinance sets a minimum lot size, and does not guarantee a right to that size. Under state law, subdivisions are required to be consistent not only with the Zoning Ordinance, but also with all the policies in the General Plan. Other factors or policies, such as the guidelines discussed below, may influence the ultimate size of a newly created lot.

**Definitions:** The “surrounding neighborhood” to be used in determining the prevailing lot size, both area and width should be determined by the following three methods.

- A discrete tract which was developed at one time and which functions as a cohesive neighborhood.
- An area defined by physical features both natural and human-made including creeks, ridges, and

roads. These features function as barriers and define an integral area.

- A discrete unit of similarly sized lots which are contiguous and have an established pattern of large single family lots larger than the minimum zoning requirement.

The existing “prevailing lot” on which is based the appropriate lot size both area and width, for a new subdivision should be determined by one of the following two methods:

- Predominant lot size (the lot size that occurs with the greatest frequency within a neighborhood); or
- Average area of lots within a surrounding neighborhood.

In addition, during the project review process, the decision-making body shall evaluate neighborhood character and external influences which affect that character prior to approval of infill development applications. Drastic changes to the neighborhood character based on this evaluation shall be grounds for denial of projects. This evaluation should address the following issues:

- Traffic conditions, street width, and parking
- Public services and utilities
- Building height
- Natural features such as mature vegetation and creeks
- Slopes and excessive grading

### Fairview Specific Plan: Lot Size Consistency

New single family parcels must be consistent with the existing land use pattern of the surrounding neighborhood. Even though subdivision proposals may meet the minimum requirements for lot size or median lot width, they may not create lots substantially smaller or narrower than the prevailing lots in the neighborhood. The “surrounding” neighborhood to be used in determining the prevailing lot size; both area and width, should be determined by one of the following three methods:

- A discrete tract that was developed at one time and which functions as a cohesive neighborhood.
- An area defined by physical features, both natural and human-made, including creeks, ridges, and roads. These features function as area boundaries that define an integral area.
- A discrete unit of contiguous, similarly sized lots that have an established pattern of single family lots larger than the minimum requirement.

The existing “prevailing lot” on which is based “the appropriate lot size, both area and width, for any new subdivision should be determined by the larger of the following two methods by the approval authority:

- Predominant lot area and width (that which occurs with the greatest frequency within the neighborhood); or
- Median area and width of lots within a surrounding neighborhood.

In addition, during the review process, which includes community input, the decision making body will evaluate neighborhood character and external influences which affect that character prior to approval of

infill development applications. Significant changes to the neighborhood character that cannot be mitigated or which can be mitigated but which significantly adversely impact the neighborhood may be grounds for denial of a project. This evaluation shall address the following issues: traffic conditions, street width, parking, public services and utilities, building height, natural features such as mature vegetation and creeks, slopes and grading, and retention of existing areas of contiguous open space.

*Page Intentionally Left Blank*





ALAMEDA COUNTY  
**Community Development Agency**

**PLANNING DEPARTMENT**

224 W. Winton Ave., Room 111  
Hayward, CA 94544

phone 510.670.5400  
fax 510.785.8793  
[www.acgov.org/cda](http://www.acgov.org/cda)